



More Precision

thermoMETER // Non-contact infrared temperature sensors





thermoMETER CTfast

IR temperature sensor with extremely short response time

- Measuring range from -50 °C to 975 °C
- One of the smallest infrared sensors worldwide with extremely short response times from 3 ms (50 % signal) to 6ms (90 % signal)
- Up to 120 °C ambient temperature without cooling
- Fast and scalable analog output with intelligent real-time data processing
- Separate controller with programming keys and backlit display

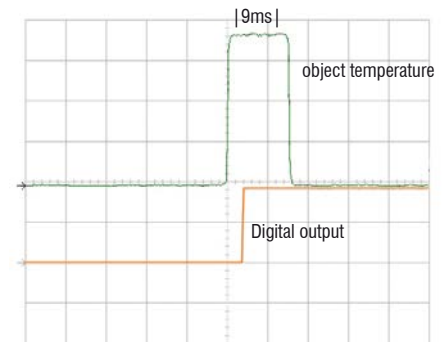

Switching output with a threshold of 50 % of the signal (SF15 model)

Optical specifications thermoMETER CTfast

□ =smallest spot size / focal point (mm)

Standard Focus														
SF15	15:1	6.5	11.6	16.6	21.7	26.7	35	43.3	51.6	59.9				
SF25	25:1	6.5	7.3	8	12	16	20	24	28	32	36	40	44	
	distance in mm	0	100	200	300	400	500	600	700	800	900	1000	1100	
Close Focus (with optionally available CF lens)														
CF15	15:1	7	3.9	0.8	4.7	8.6	12.5	16.4	20.3	24.2				
	distance in mm	0	5	10	15	20	25	30	35	40				
CF25	25:1	6.5	3.5	0.5	4	7.5	11	15.4	19.8	24.1	28.5			
	distance in mm	0	4	8	12	16	20	25	30	35	40			

Model	CTF-SF15-C3	CTF-SF25-C3
Optical resolution	15:1	25:1
Temperature range ¹⁾	-50 °C to 975 °C	
Spectral range	8 to 14 μm	
System accuracy ²⁾	±1 % or ±2 °C	
Repeatability ²⁾	±0.75 % or ±0.75 °C	
Temperature resolution ^{3), 4)}	0.2 °C	0.4 °C
Response time ⁵⁾	9 ms (90 %) at analog output 4 ms (50 %) at digital output	6 ms (90 %) at analog output; 3 ms (50 %) at digital output
Emissivity/gain ¹⁾	0.100 to 1.100	
Transmissivity/gain ¹⁾	0.100 to 1.100	
Signal processing ¹⁾	peak hold, valley hold, average; extended hold function with threshold and hysteresis	
Certificate of calibration	optional	
Outputs/analog	0/4 to 20 mA, 0 to 5/10 V, thermocouple J, K	
Alarm output	open collector (24 V / 50 A)	
Outputs/digital	standard: 0/10 V (10 mA); optional: relays 2 x 60 VDC/42 VAC; 0.4 A; electrically isolated	
Digital Interface	optional	USB, RS232, RS485, Modbus RTU, Profibus DP, Ethernet
Output impedances	current output	mA max. 500 Ω (with 8 to 36 VDC)
	voltage output	min. 100 kΩ load impedance, thermocouple 20 Ω
Inputs	programmable functional inputs for external emissivity adjustment ambient temperature compensation, trigger (reset of hold functions)	
Cable length	1 m, 3 m (standard), 8 m, 15 m	
Power supply	8 to 36 VDC; max. 100 mA	
Protection class	IP65 (NEMA-4)	
Ambient temperature	sensor: -20 °C to 120 °C; controller: 0 °C to 85 °C	
Storage temperature	sensor: -40 °C to 120 °C; controller: -40 °C to 85 °C	
Relative humidity	10 to 95 %, non-condensing	
Vibration	sensor	IEC 68-2-6: 3 G, 11-200 Hz, any axis
Shock	sensor	IEC 68-2-27: 50 G, 11 ms, any axis
Weight	sensor: 40 g; controller: 420 g	

¹⁾ adjustable via programming keys or software

²⁾ ambient temperature 23 ±5 °C; whichever is greater with dynamic noise compression

³⁾ temperature of the object ≥ 20 °C

⁴⁾ with dynamic adaption at low signal levels

⁵⁾ with time constant of 100 ms with adaptive averaging T_{0.95} 25 °C

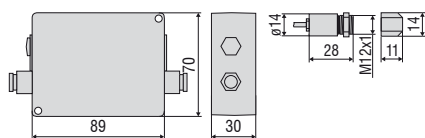

Product identification

CTF-	SF15-	C3
		Cable length [1 m / 3 m (standard) / 8 m / 15 m]
		Focus [SF15 / SF25]
thermoMETER CTFast		

Accessories page 40 - 43

- Ancillary CF lens
- Protective window
- Mounting bracket / mounting bolt
- Air purge collar
- Right angle mirror
- Rail mount adapter for controller
- Massive housing
- Protective tube
- Laser sighting aid
- Digital-interface kits
- Certificate of calibration

CT / CTfast / CTM1/M2/M3

controller

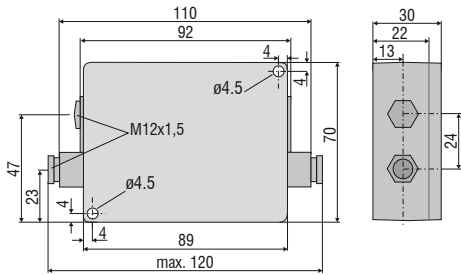

ancillary CF lens (optional)



sensor

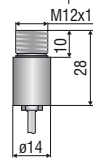

CThot / CTP-3 / CTP-7

controller

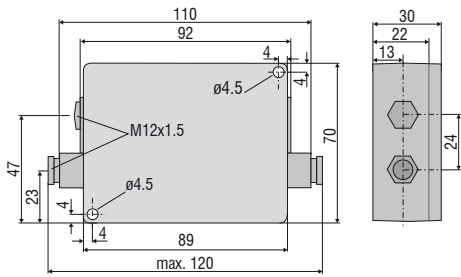

sensor with protective housing

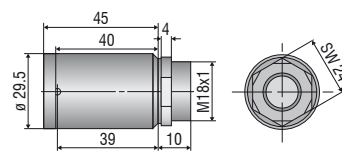

CTM3-XL

controller

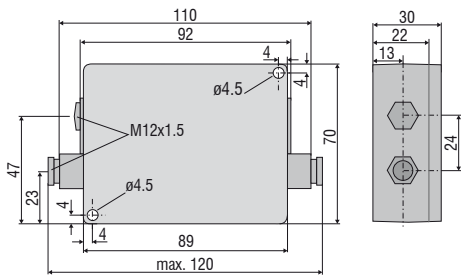

sensor

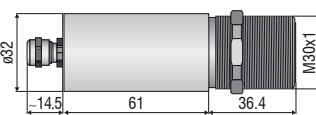

CTex

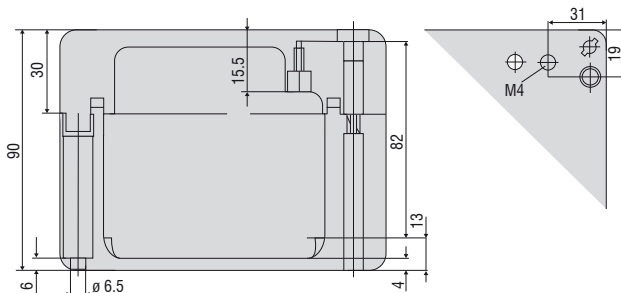
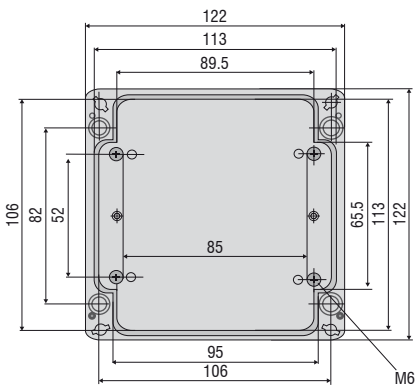

Mechanical accessories		
Art. No.	Model	
2970203	TM-FB-CT	Mounting bracket, fixed
2970325	TM-FB2-CT	Mounting bracket, adjustable in one axis, for simultaneous assembly of CT sensor and laser sighting aid
2970336	TM-FBMH-CT	Mounting bracket, adjustable in one axis, for massive housing
2970204	TM-AB-CT	Mounting bracket, adjustable in 2 axes
2970205	TM-MB-CT	Mounting bolts with M12x1 thread
2970206	TM-MG-CT	Mounting fork, adjustable in 2 axes, with M12x1 fastening
2970207	TM-AP-CT	Air purge collar for sensors from 10:1 lens
2970335	TM-APS-CT	Air purge collar for sensors from 10:1 lens made from stainless steel
2970208	TM-AP2-CT	Air purge collar for sensor with 2:1 lens
2970209	TM-APL-CT	Air purge collar, laminar
2970210	TM-APLCF-CT	Air purge collar, laminar with integrated ancillary CF lens
2970357	TM-APLCFH-CT	Air purge collar, laminar with integrated ancillary CF lens for M1/M2/M3/M5 sensors
2970386	TM-APMH-CT	Air purge collar made from stainless steel for massive housing
2970463	TM-TAS-CT	Pivoted joint for CT sensors
2970211	TM-RAM-CT	Right angle mirror for measurements 90 °C to the sensor axis
2970212	TM-RAIL-CT	Rail mount adapter for CT controller
2970213	TM-COV-CT	Closed cover for controller
2970214	TM-MHS-CT	Massive housing made from stainless steel
2970215	TM-MHSFC-CT	Massive housing made from stainless steel with integrated ancillary CF lens
2970358	TM-MHSFCFH-CT	Massive housing made from stainless steel with integrated ancillary CF lens for M1/M2/M3/M5 sensors
2970216	TM-MHA-CT	Massive housing made from anodized aluminum
2970217	TM-MHACF-CT	Massive housing made from stainless steel with integrated ancillary CF lens
2970359	TM-MHACFH-CT	Massive housing made from anodized aluminum with integrated ancillary CF lens for M1/M2/M3/M5 sensors
2970326	TM-PA-CT	Pipe adapter for the mounting of reflection protection tubes
2970327	TM-ST20-CT	Reflection protection tube, length 20 mm
2970328	TM-ST40-CT	Reflection protection tube, length 40 mm
2970329	TM-ST88-CT	Reflection protection tube, length 88 mm
2970221	TM-LST-CT	Laser sighting aid for CT sensors incl. batteries (2xAlkaline AA)
2970300	TM-LSTOEM-CT	OEM laser sighting aid, 635 nm, 3.5 m cable, for connection to CT controller
2970300.008	TM-LSTOEM-CT(008)	OEM laser sighting aid, 635 nm, 8 m cable, for connection to CT controller

Optical accessories		
Art. No.	Model	
2970201	TM-CF-CT	Ancillary CF lens (only for SF models)
2970202	TM-PW-CT	Protective window (only for SF models)
2970297	TM-CFAG-CT	Ancillary lens with external thread
2970330	TM-CFH-CT	Ancillary lens for M1/M2/M3/M5 sensors
2970331	TM-CFHAG-CT	Ancillary lens with external thread for M1/M2/M3/M5 sensors
2970299	TM-PWAG-CT	Protective window with external thread
2970332	TM-PWH-CT	Protective window for M1/M2/M3/M5 sensors
2970333	TM-PWHAG-CT	Protective window with external thread for M1/M2/M3/M5 sensors

Interfaces		
Art. No.	Model	
2970729	TM-USBK-CT	USB-Interface-board, cable with Micro-USB plug and adapter for USB-C and USB-A, CompactConnect software (as download), Quick reference, second cable gland for controller
2970224	TM-RS232K-CT	RS232 interface: RS232 interface, computer cable, CompactConnect software, second cable gland for controller
2970338	TM-RS485USBK-CTL	RS485-USB-adapter, incl. PC cable, CompactConnect software and CTmulti, second cable gland for use with interface board TM-RS485B-CT
2970226	TM-RS485B-CT	RS485 interface board incl. second cable gland
2970227	TM-CANK-CT	CAN-Bus interface for thermoMETER CT/ protocol: CANopen presets: module address 20 (14H), 250 kBaud, 0-60 °C
2970228	TM-PFBDPK-CT	Profibus-DPv1 interface for thermoMETER CT with plug-in connection
2970229	TM-ETHNK-CT	Ethernet-Kit: interface board, external Ethernet adapter, CompactConnect software, second cable gland
2970230	TM-RI-CT	Relay interface: two electrically isolated relays, 60 VDC/ 42 VAC _{eff} , 0.4 A

Calibration		
Art. No.	Model	
2970231	TM-CERT-CT	Certificate of calibration
2970310	TM-HTCERT-CT	Certificate of calibration for CTM sensors

CTM3-XL		
Art. No.	Model	
2970352	TM-FBXL-CT	Mounting bracket, adjustable in one axis
2970353	TM-ABXL-CT	Mounting bracket, adjustable in 2 axes
2970354	TM-APXL-CT	Air purge collar, stainless steel
2970361	TM-XLCERT-CT	Certificate of calibration



TM-FB-CT Mounting bracket, adjustable in one axis



TM-CF-CT Ancillary CF lens (only for SF models)



TM-CFAG-CT Ancillary CF lens with external thread
TM-PWAG-CT Protective window with external thread



TM-AB-CT Mounting bracket, adjustable in two axes



TM-MB-CT mounting bolt with M12x1 thread adjustable in one axis



TM-APL-CT Air purge collar, laminar and
TM-MG-CT Mounting fork



TM-MG-CT Mounting fork with M12x1 thread, adjustable in two axes



TM-APLCF-CT
Ancillary CF lens/protective window - integrable variant
for laminar air purge collar



TM-RAIL-CT rail mount adapter for controller



TM-KF40GE-CT KF40 Flange with Ge window
TM-KF40B270-CT KF40 Flange for CTM-1,-2,-3
with B270 window



TM-APMH-CT
Air purge collar made from stainless steel
for massive housing



TM-PA-CT Pipe adapter for reflection protection tube



TM-ST40-CT Reflection protection tube





TM-LST-CT Laser sighting aid, battery-operated
(2x Alkaline AA), for alignment of CT sensors
(dimensions identical to CT sensor)



TM-FB2-CT
Mounting bracket for sensor and laser sighting aid



TM-RAM-CT
Right angle mirror



TM-MHS-CT Massive housing, stainless steel
TM-MHA-CT Massive housing, aluminum

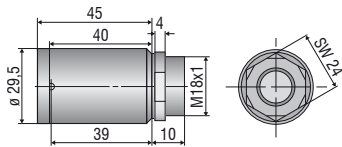

TM-TAS-CT Pivoted joint for CT sensors



Dirt and deposit on the lens like smoke, steam and high air humidity (condensation) are avoided or reduced by using an air purge collar.

TM-AP-CT
Standard air purge collar for 10:1 / 15:1 / 22:1 lenses
TM-APS-CT
Air purge collar, stainless steel



TM-AP2-CT
Standard air purge collar for 2:1 lens

Infrared thermal imagers from Micro-Epsilon



thermoIMAGER TIM Compact thermal imaging cameras for industrial temperature monitoring

- Temperature range from -20 °C to 2450 °C
- Ideal for OEM
- Real-time thermography using license-free software
- Protective housing for harsh environments
- Special variants for the glass, metal and plastics industries