

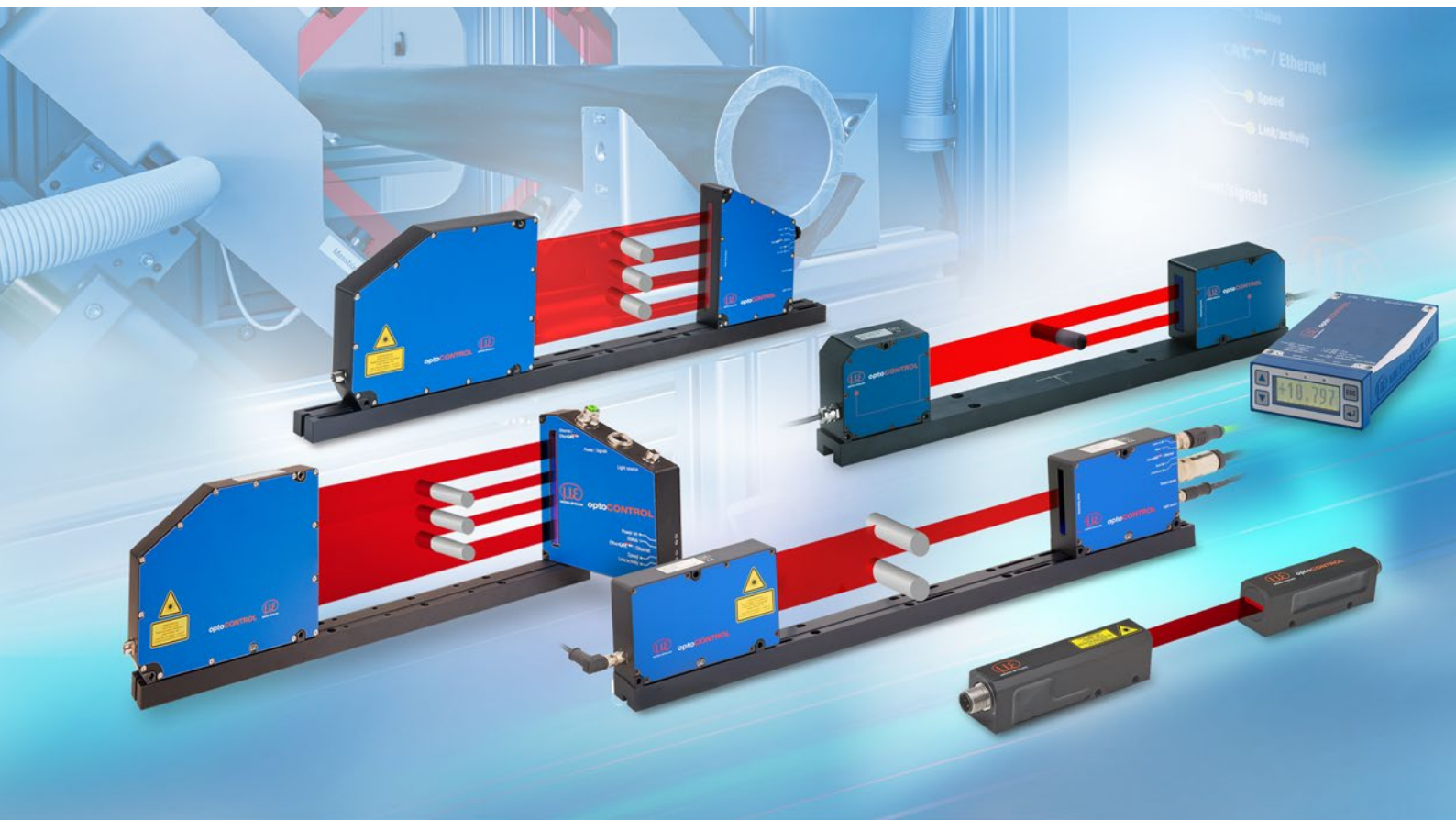







More Precision

optoCONTROL // Optical precision micrometers



High-resolution LED micrometer optoCONTROL 2600

-  Measuring range 40 mm
-  Resolution 0.1 μm
-  Measuring rate 2.3 kHz
-  Linearity typ. $\pm 3 \mu\text{m}$
- INTER FACE** Analog output 0 to 10 VDC
Serial interface RS232/USB
-  LED light source

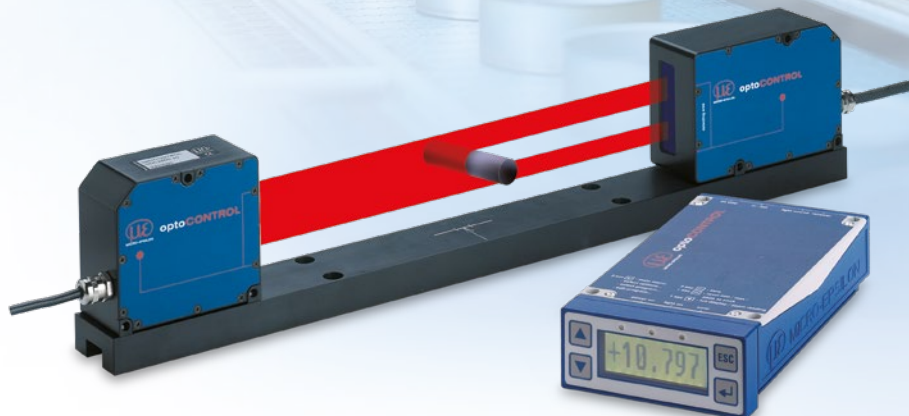

The optoCONTROL 2600 is an optical measuring system with an integrated, high resolution CCD camera. The measurement data received is output via digital or analog interfaces. The micrometer is highly independent of ambient light.

The optoCONTROL 2600 consists of a sensor unit attached to a mounting rail. The sensor unit includes a light source with high-power LED and a receiver with telecentric lens and CCD array. The sensor unit is controlled and evaluated by an intelligent controller with graphic display for operation and readings.

The adjustable light source allows precise measurement of most transparent objects. By combining the LED with the telecentric optics, significantly higher accuracy and repeatability of the measurement data are made possible. The system is insensitive to interferences such as dust or ambient light.

Predefine measurement modes

(6 individual and adjustable programs)

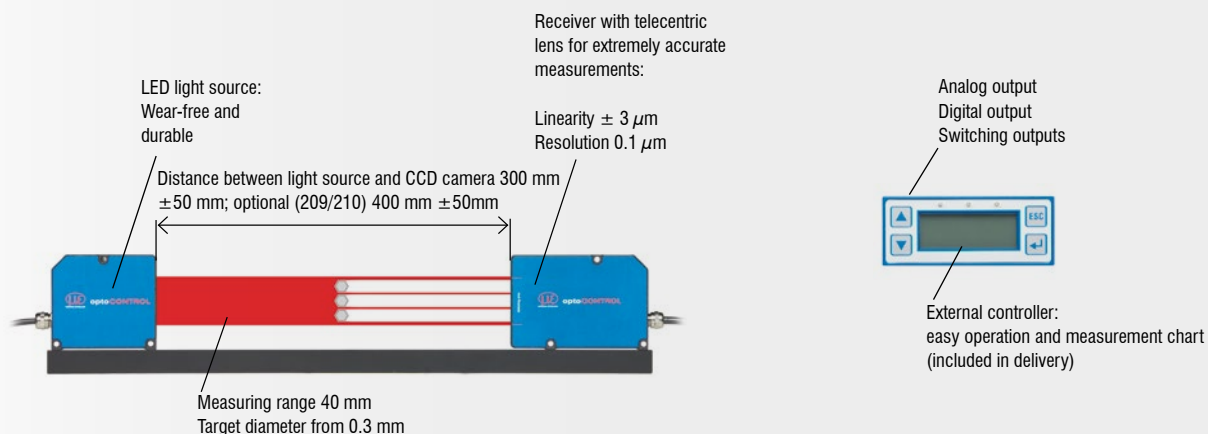
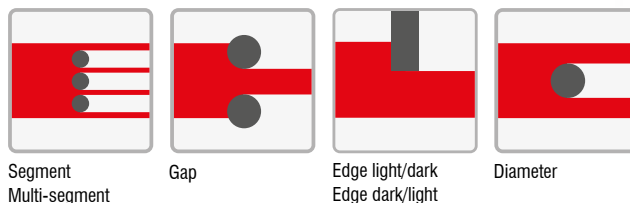

Model	ODC2600-40		ODC2600-40(209)	ODC2600-40(210)
Measuring range	40 mm			
Min. target size	0.3 mm			
Distance light source - receiver (free space) ¹⁾	300 (±50) mm		400 (±50) mm	400 (±50) mm
Measuring distance (target - receiver)	150 (±5) mm		200 (±5) mm	200 (±5) mm
Measuring rate	2.3 kHz			
Resolution ¹⁾	0.1 μm			
Linearity ²⁾	< ±3 μm			
Repeatability ^{2) 3)}	±1 μm		±1.5 μm	±1.5 μm
Light source	red LED 625 nm			
Analog output	0 to 10 VDC, ±10 VDC, selectable			
Digital interface	RS232 (115.2 kBaud); RS422 (691.2 kBaud)			
Switching output	Error, 4x limit values; max. 30V DC ≤ 100 mA			
Signal input	Zero setting/reset; trigger/light (on/off); synchronization			
Digital output	Synchronization ⁴⁾			
Connection	Receiver	integrated cable, length 2 m 12-pole		
	Light source	integrated cable, length 2 m 5-pole		
	Controller	Receiver: 12-pole M8 socket; light source: 5-pole socket for light source Supply: 3-pole socket; signal: 25-pole SUB-D socket		
Mounting	Mounting rail (see accessories), mounting holes			
Temperature range	Storage	-20 °C ... +70 °C (non-condensing)		
	Operation	0 °C ... +50°C (non-condensing)		
Supply voltage	+24 VDC (±15 %)			
Maximum power consumption	< 1 A			
Shock (DIN EN 60068-2-27)	15 g / 6 ms			
Vibration (DIN EN 60068-2-6)	2 g / 20 ... 500 Hz			
Protection class (DIN EN 60529)	Receiver / light source	IP64		
	Controller	IP40		
Material	Receiver / light source	Aluminum housing		
	Light source	450 g		
Weight	Receiver	800 g		
	Controller	1200 g		
	Mounting rail	900 g	1100 g	-
Measuring programs	Edge light-dark; edge dark-light; (outside) diameter/width; gap/(inside diameter); any segment edge			
Control and indicator elements	LCD display (value, maximum, minimum, peak-to-peak) measurement chart in mm / inch, selectable; menu language in German / English, selectable; 3x LEDs (power on, light on, error)			
Special features	4 editable user programs			

The specified data apply for a consistent room temperature of 20 °C, after a warm-up time of 30 min.

¹⁾ Resolution of the digital display (resolution of digital output 0.6 μm)

²⁾ Measured with 3 sigma; edge measurement without averaging, working distance 150±5 mm, option 209/210: 200 mm ± 5 mm

³⁾ Measured with static noise over 3 min.

⁴⁾ Only for synchronization of two or more optoCONTROL 2600 models

High-resolution LED micrometer optoCONTROL 2600-40

Controller

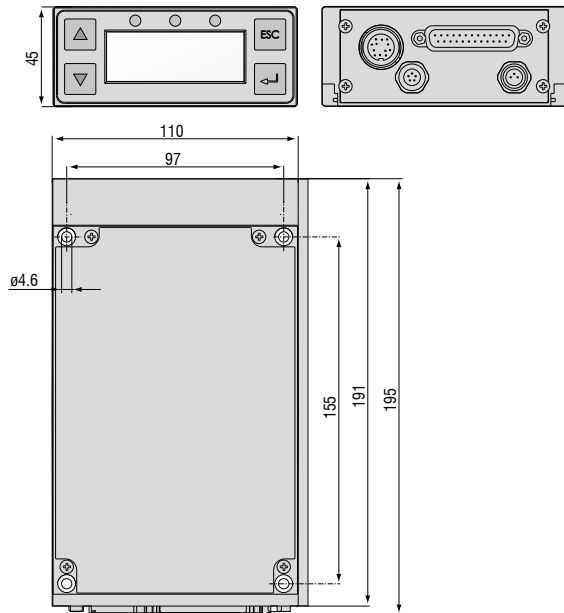

optoCONTROL 2600-40

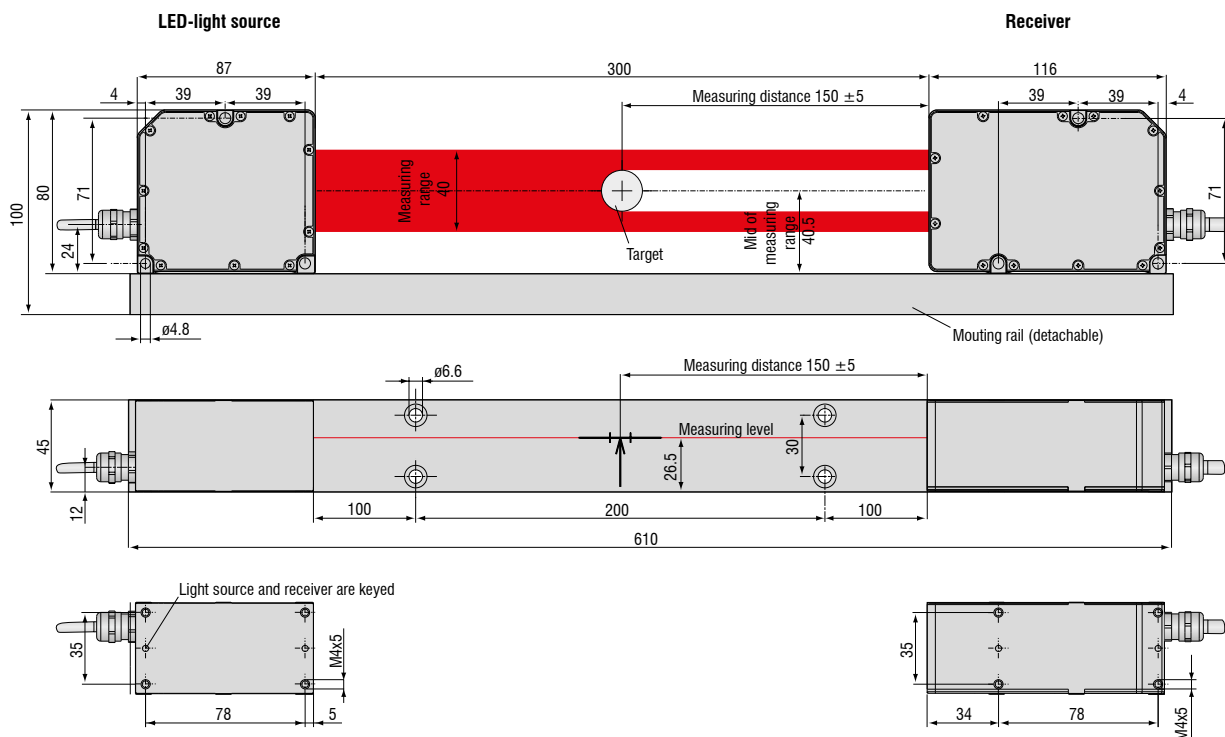

optoCONTROL 2600-40(209)

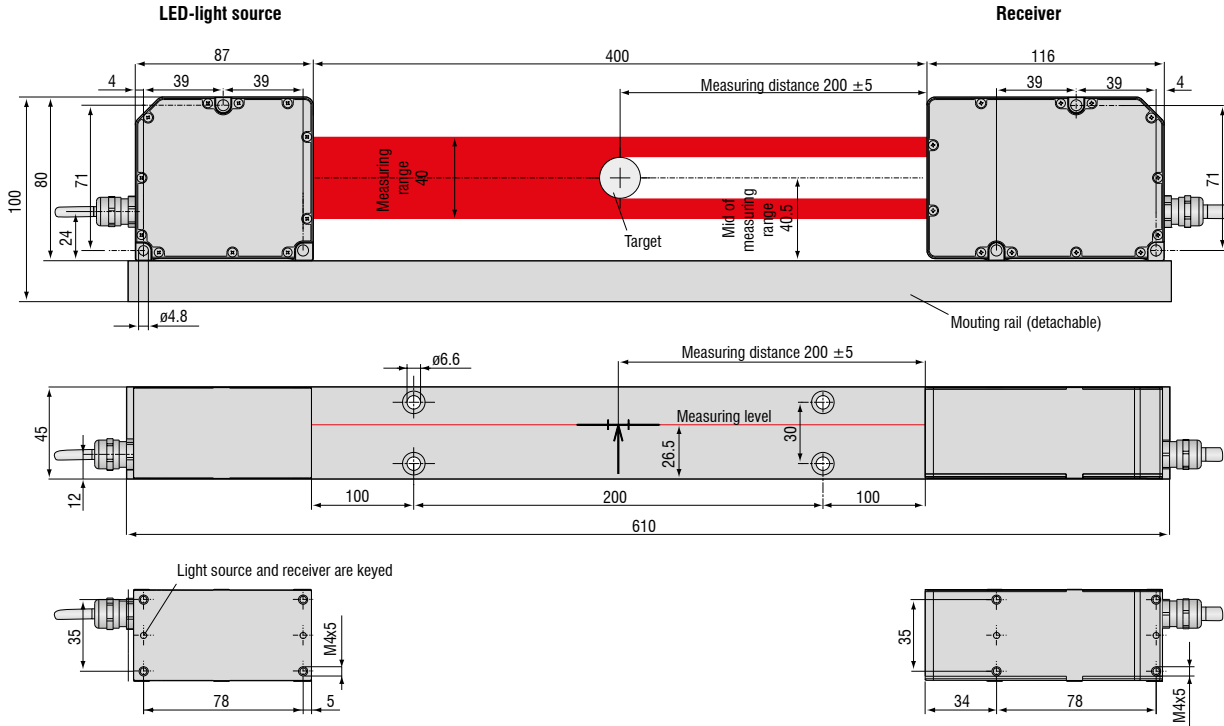

optoCONTROL 2600-40(210)

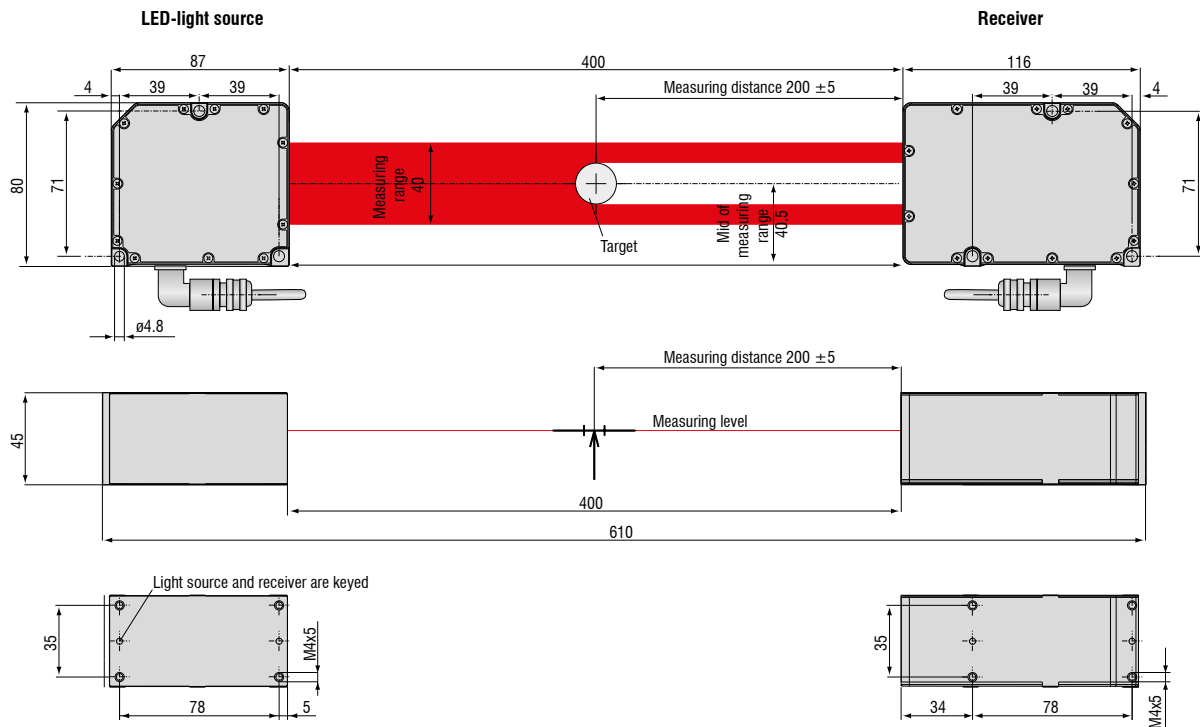

Interface modules and accessories

optoCONTROL

XFrame2520 for 2-axis measurements

Accessory for the integration of optical ODC2520-46 micrometers for diameter measurements

- 2-axis frame for X-arrangement of 2 sensors
- Optics can be cleaned with compressed air
- e.g. for wires, cables, tubes, rods or flat steel
- Objects up to 46 mm diameter measurable
- Measuring range 46 x 46 mm
- Evaluation of the two sensors via universal controller possible (not included in scope of delivery)



Various ODC tools for ODC2520 and ODC2600

Depending on the sensor, diverse tools for continuous measurement value recording and parameter set up are available free of charge

- ODC2600 & ODC2500 Tool: For parameterization and continuous recording of measured values.
- SensorTOOL: The measured values of one or more micrometers can be graphically displayed and recorded simultaneously.



Interface modules

Module	ODC1200	ODC2520	ODC2600
IF2001/USB RS422/USB converter to transform a digital signal to USB	⊘	✓	✓
IC2001/USB Single-channel RS422/USB converter cable	⊘	✓	✓
IF2004/USB RS422/USB converter to convert up to 4 digital signals to USB	⊘	✓	✓
IF2008/ETH Interface module for Ethernet connection for up to 8 sensors	⊘	✓	⊘
IF2008PCIE Interface card for multiple sensor signals; analog and digital interfaces	✓	✓	✓
IF2035-EtherCAT Interface module for Industrial Ethernet connection (EtherCAT)	⊘	✓	⊘
IF2035/PROFINET Interface module for Industrial Ethernet connection (PROFINET)	⊘	✓	⊘
IF2035/EtherNetIP Interface module for Industrial Ethernet connection (EtherNet/IP)	⊘	✓	⊘
IF1032/ETH Interface module for connecting the analog interface to Ethernet or Industrial Ethernet (EtherCAT)	✓	⊘	⊘

IF2001/USB converter RS422 to USB

The RS422/USB converter converts the digital signals of an optical micrometer into a USB data packet. The sensor and the converter are connected via the RS422 interface of the converter. Data output is done via USB interface. The converter loops through further signals and functions such as laser on/off, switch signals and function output. The connected sensors and the converter can be programmed through software.

Special features

- Robust aluminum housing
- Easy sensor connection via screw terminals (plug and play)
- Conversion from RS422 to USB
- Supports baud rates from 9.6 kBaud to 12 MBaud

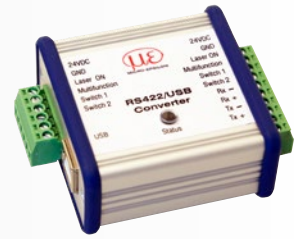

IC2001/USB Single-channel converter cable RS422/USB

The IC2001/USB single-channel converter cable is used for the USB connection of optoCONTROL sensors equipped with an RS422 interface. The cable is easy to assemble and can therefore also be used for installation in machines and systems.

Special features

- 5-core interface cable without outer shield
- Conversion from RS422 to USB
- Easy sensor connection via USB
- Supports baud rates from 9.6 kBaud to 1 MBaud



IF2004/USB: 4-channel converter from RS422 to USB

The RS422/USB converter is used for transforming digital signals from up to four precision micrometers into USB data signals. The converter has four trigger inputs and a trigger output for connecting additional converters. Data is output via an USB interface. The connected sensors and the converter can be programmed through software. The COM interfaces can be used individually and can be switched.

Special features

- 4x digital signals via RS422
- 4x trigger inputs, 1x trigger output
- Synchronous data acquisition
- Data output via USB

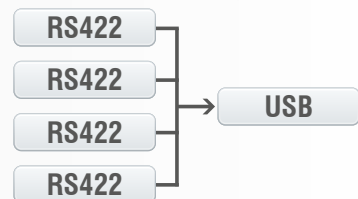

IF2008/ETH

IF2008/ETH Interface module for Ethernet connection with up to 8 sensors

The IF2008/ETH integrates up to eight sensors and/or encoders with an RS422 interface into an Ethernet network. Four programmable switching in-/outputs (TTL and HTL logic) are available.

Ten indicator LEDs directly on the module show both the channel and the device status. In addition, acquisition and output of data via Ethernet is in addition performed at high speeds up to 200 kHz. Parameter setting of the interface module can be easily done via the web interface.



Interface modules and accessories

optoCONTROL

IF2008PCIe/IF2008E

Interface card for synchronous data acquisition

Absolute synchronous data acquisition is a decisive factor for the deflection or straightness measurement using several laser sensors. The IF2008PCIe interface card is designed for installation in PCs and enables the synchronous capture of four digital sensor signals and two encoders. The data is stored in a FIFO memory in order to enable resource-saving processing in blocks in the PC. The IF2008E expansion board enables to detect in addition two digital sensor signals, two analog sensor signals and eight I/O signals.

Special features

- IF2008PCIe - Basic printed circuit board: 4 digital signals and 2 encoders
- IF2008E - Expansion board: 2x digital signals, 2x analog signals and 8x I/O signals

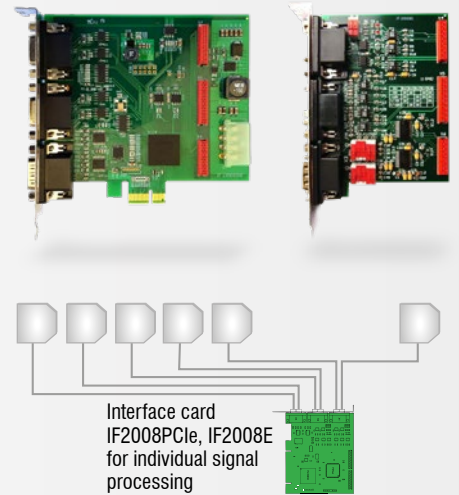

IF2035

Interface module for Industrial Ethernet connection

The IF2035 interface modules are designed for easy connection of Micro-Epsilon sensors to Ethernet-based fieldbuses. The IF2035 is compatible with sensors that output data via an RS422 or RS485 interface and supports the common Industrial Ethernet protocols EtherCAT, PROFINET and EtherNet/IP.

These modules operate on the sensor side with up to 4 MBd and have two network connections for different network topologies. In addition, the IF2035-EtherCAT offers a 4-fold oversampling function, which enables faster measurements than the bus cycle allows, if required. Installation in control cabinets is via a DIN rail.

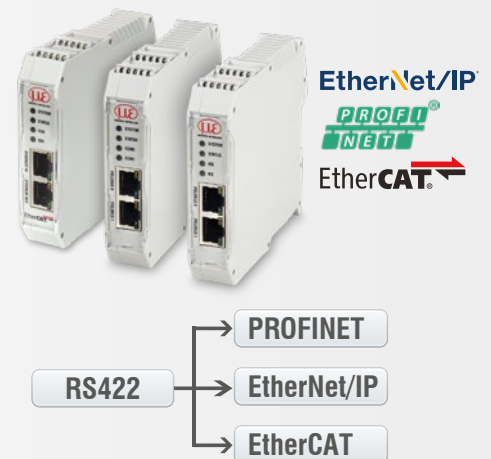

IF1032/ETH







The IF1032/ETH interface module now enables to run micrometers equipped with analog interfaces with the proven operating concept based on a web interface. The Ethernet interface permits to easily display the measured data on a PC. Moreover, micrometers can be connected to an EtherCAT bus. The RS485 interface allows to connect new micrometers that use the Micro-Epsilon specific RS485 protocol.

Interfaces













- Ethernet/EtherCAT
- 1x RS485 (ME-internal protocol)
- 2x analog-in (14 bit, max. 4 ksps), voltage
- 1x analog-in, (14 bit, max. 4 ksps), current
- Inputs for supply voltage
- Trigger input
- EtherCAT synchronization output
- Output for sensor power supply



optoCONTROL 1200/1201

Connection	Interface modules	Connection cables	Mounting	Accessories
Power supply Power supply unit PS2031 2420096 Power supply unit PS2020 2420062		Power supply and signal cables PC1200/90-5 (5 m) (90°) 2901261 PC1200-5 (5 m) 2901260 PC1200-10 (10 m) 2901483		Adjustment plate <u>Receiver</u> JU1200-HR (horizontal) 2966018 JU1200-VR (vertical) 2966019 <u>Transmitter</u> JU1200-VT (vertical) 2966020 JU1200-HT (horizontal) 2966021
Digital output / Ethernet / EtherCAT 	IF1032/ETH 2420066 max. 4 kSps 			 (for 1200 and 1200/90)
PLC Analog Connection via 0 ... 10 V 	Direct 0 - 10 VDC		Mounting rail for C-frame mounting ODC1202-L100 (L=0.4 m) 2966006 ODC1202-L200 (L=0.5 m) 2966007 ODC1202-L500 (L=0.8 m) 2966008  (for 1200 and 1200/90)	Bracket for C-frame mounting BR1200L220 (L=220 mm) 2966024 BR1200L320 (L=320 mm) 2966025

optoCONTROL 2600

Connection	Interface modules	Connection cables	Mounting	Accessories
Power supply Power supply unit PS2031 2420096 Power supply unit PS2020 2420062		Supply cables (open) PC2500-3 (3 m) 2901123 PC2500-10 (10 m) 2901124		Demo prism incl. testing pins 9335380 
Serial or analog connection to PC or PLC 	Direct 0 - 10 VDC Direct RS232 SUB-D9 Direct RS422 SUB-D9 Direct RS422 OE	Output cables IO analog SCA2500-3 (3 m analog) 2901120 SCA2500-10 (10 m analog) 2901215 Signal output cables serial RSxxx SCD2500-3/3/RS232 (3 m) 2901121 (analog + signals / 3 m RS232) SCD2500-3/10/RS422 (3 m) 2901122 (analog + signals / 10 m RS422) SCD2500-3/RS422 2901111 (3 m only RS422 open ends)		Diameter of testing pins - 20 mm - 10 mm - 6 mm - 3 mm
USB 	IF2004/USB 2213024 4-port RS422  IC2001 / USB 2213041  IF2001/USB converters 2213025 	Signal output cable SCD2500-3/10/RS422 (3 m) 2901122 (analog + signals / 10 m RS422) IF2008-Y-adaptor cable (0.1 m) 2901528 For the connection of a 3rc  Signal output cables SCD2500-3/RS422 (3 m) 2901111 (only RS422 open ends)		Extension cable For controller receiver units: CE1800-3 (3 m) 2901057 CE1800-8 (8 m) 2901058 For controller light sources: CE2500-3 (3 m) 2901118 CE2500-8 (8 m) 2901119
Digital output PCIE Card installation 	IF2008PCIE 2213032  IF2008E 2213032 	Interface cables for IF2008 SCD2500-3/IF2008 (3 m) 2901561 SCD2500-8/IF2008 (8 m) 2901563 IF2008-Y-adaptor cable (0.1 m) 2901528 For the connection of a 3rd or 4th sensor 		

Basics & selection criteria

optoCONTROL

All sensors of the optoCONTROL series operate according to the shadow casting / ThruBeam principle. A cross section of the contour of a target is measured with high accuracy. Three types of ThruBeam technologies are used in the different optoCONTROL series to cover a wide range of applications.

Light quantity measurement (ODC1200/1201)

In light quantity measurement, an optical system fans the light from a red laser diode to create a parallel light curtain. The light curtain is aligned with the receiver unit. In the receiver unit, a precision aperture guides the light through various filters and optical components onto a light-sensitive detector. An analog electronic system processes the amount of incident light and outputs this data as an analog signal.

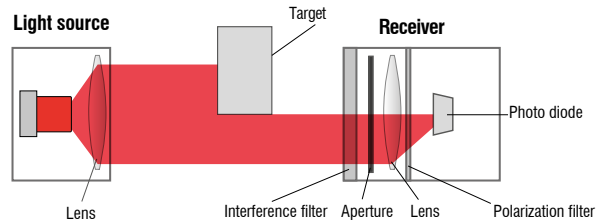

Colometry ODC25xx

Colometry is a laser-based measuring system with an integrated high-resolution line scan camera for measuring geometric quantities. It measures the dimension of a target or the position of an edge on a body using the shadowing principle. A parallel light curtain is generated with a laser light source. The camera in the receiver unit measures the contour of the target using the shadow generated on the pixel-based array.



Telecentric method ODC2600

The telecentric method is a measuring system with an integrated high-resolution line scan camera. The light source illuminates the target from behind. There is a telecentric objective lens in the receiver. It provides an image of the same size in the so-called telecentric range and produces a constant accuracy. The advantages of the telecentric lens are the free positioning of the target within the telecentric range (± 5 mm) and the relatively high tolerance to contamination and ambient light. The line scan camera in the receiver also measures the projected outer contour of the target.

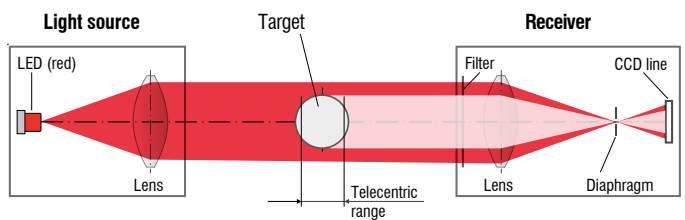

LASER RADIATION
DO NOT VIEW DIRECTLY
WITH TELESCOPE OPTICS
CLASS 1M LASER PRODUCT
IEC 60825-1: 2014
P<2mW, Es<0.2mW/cm², λ=670nm

optoCONTROL 2520 uses a semiconductor laser, 670nm \leq 2mW max. optical power, laser class 1M. No additional protective measures are required for the use of these devices. Be careful with the dazzling effect related to optical instruments.



Class 1 Laser Product
IEC 60825-1: 2014
P<0.39 mW; λ=670 nm
COMPLIES WITH 21 CFR 1040.10 AND 1040.11
EXCEPT FOR CONFORMANCE WITH IEC 60825-1
ED. 3. AS DESCRIBED IN
LASER NOTICE NO. 56, DATED MAY 8, 2019.

optoCONTROL 12xx uses a semiconductor laser, 670 nm, \leq 0.39 mW max. optical power, laser class 1. No additional protective measures are required for the use of these devices.



Sensors and systems for displacement, distance and position



Sensors and measurement devices for non-contact temperature measurement



Measuring and inspection systems for metal strips, plastics and rubber



Optical micrometers and fiber optics, measuring and test amplifiers



Color recognition sensors, LED analyzers and inline color spectrometers



3D measurement technology for dimensional testing and surface inspection