



More Precision

eddyNCDT // Inductive sensors based on eddy currents





 High resolution & linearity

 100kHz High speed measurements: up to 100 kHz (-3dB) frequency response

 Numerous sensor models even for customer-specific applications

 St 37 Al Sensors for ferromagnetic and non-ferromagnetic targets

The eddyNCDT 3300 eddy current system is a powerful displacement measuring system which offers numerous benefits in manufacturing automation, machine monitoring and quality control.

Multifunctional controller

The eddyNCDT 3300 controller is equipped with high performance processors for reliable signal processing and further processing. The three-point linearization feature enables almost fully automatic field linearization, which provides high accuracy for any metallic target and installation environment. The operation is supported by a dialog-aided graphical display.

Highest frequency response

Monitoring highly dynamic processes is possible with the eddyNCDT 3300 which offers a frequency response of 100 kHz. This enables to solve measurement tasks where high measurement speeds and high accuracy are required.

Model	DT3300	DT3301
Resolution ¹⁾	static (25 Hz)	0.005 % FSO (≤ 0.01 % FSO with ES04, ES05 and EU05)
	dynamic (25 / 100 kHz)	0.2 % FSO
Frequency response (-3dB)	selectable 25 kHz, 2.5 kHz, 25 Hz; 100 kHz for measuring ranges ≤ 1 mm	
Linearity	$< \pm 0.2$ % FSO	
Temperature compensation ²⁾	+10 ... 100 °C (option TCS: -40 ... +180 °C)	
Target material ³⁾	Steel, aluminum	
Supply voltage	± 12 VDC and 5.2 VDC ⁴⁾	11 ... 32 VDC
Max. current consumption	approx. 420 mA	700 mA
Analog output	selectable 0 ... 5 V; 0 ... 10 V; ± 2.5 V; ± 5 V; ± 10 V (or inverted); / 4 ... 20 mA (short circuit proof)	
Connection	Sensor: pluggable cable via 5-pole socket Supply/signal: 8-pole M16 x 0.75 connector (cable see accessories)	
Temperature range	Storage	+25 ... +70 °C
	Operation	+5 ... +50 °C
Protection class (DIN EN 60529)	IP64 (plugged)	
Control and display elements	limit value monitoring, auto-zero, peak-to-peak, minimum, maximum, average, storage of 3 characteristics	

FSO = Full Scale Output

¹⁾ Resolution data are based on noise peak-to-peak values

²⁾ Temperature stability may differ with TCS option

³⁾ Steel: S137 steel DIN1.0037 / aluminum: AlCuMgPb3.1645 / AlMg3

⁴⁾ Additionally 24 VDC for external reset and limit switch

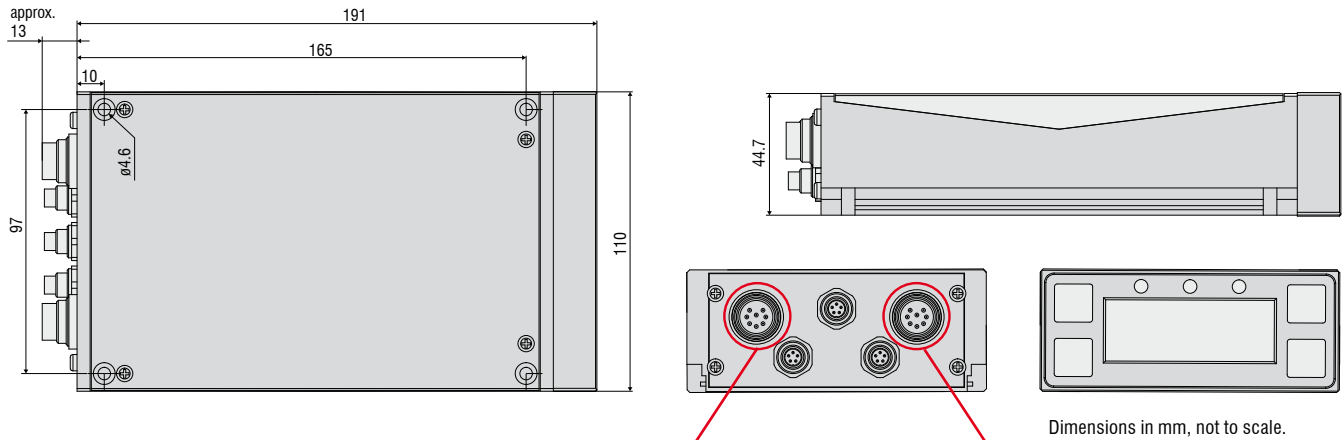

Pin assignment ANALOG - I/O

Pin	Assignment	Color (cable: SCA3/5)
1	n.c.	---
2	n.c.	---
3	Analog output U _{OUT}	Brown
4	n.c.	---
5	Temperature output ¹⁾ U _{Temp}	Green
6	n.c.	Gray
7	Agnd	White
8	Analog output I _{OUT}	Yellow

¹⁾ Signal available only as option

Pin assignment IN/OUT/24V IN

Pin	Assignment	Color (cable: SCD3/8)
1	Zeroing In	Brown
2	Limit value A Out	Yellow
3	n.c.	Blue
4	Reset limit value In	Green
5	n.c.	Pink
6	24 VDC ground	White
7	+24 VDC in	Red
8	Limit value B Out	Gray

 8-pin cable connector
View on solder side

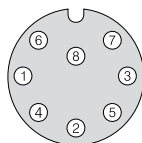

 8-pin cable connector
View on solder side

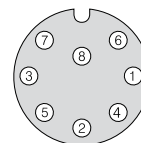

▲▲▲▲
Measurement direction

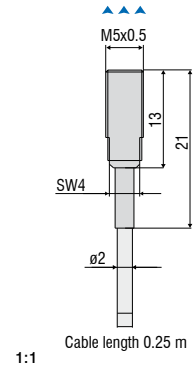
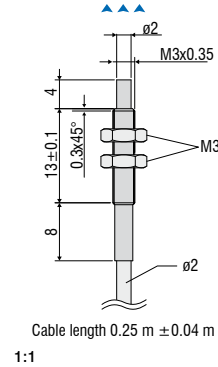
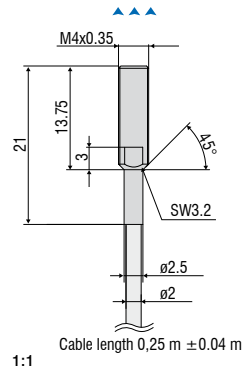

Model		ES04	EU05	ES08
Measuring range		0.4 mm	0.4 mm	0.8 mm
Start of measuring range		0.04 mm	0.05 mm	0.08 mm
Resolution ^{1) 2) 3)}		0.04 μm	0.05 μm	0.04 μm
Linearity ¹⁾		< ±0.8 μm	< ±1 μm	< ±1.6 μm
Temperature stability ^{1) 2) 4)}		< 0.06 μm / K	< 0.075 μm / K	< 0.12 μm / K
Temperature compensation ⁴⁾		0 ... +90 °C	0 ... +90 °C	0 ... +90 °C
Min. target size (flat)		Ø 6 mm	Ø 9 mm	Ø 7.5 mm
Sensor type		shielded	unshielded	shielded
Connection		integrated cable, axial, length approx. 0.25 m ⁵⁾	integrated cable, axial, length approx. 0.25 m ⁵⁾	integrated cable, axial, length approx. 0.25 m ⁵⁾
Mounting		Cable gland (M4)	Cable gland (M3)	Cable gland (M5)
Temperature range	Storage	+20 ... +150 °C	+20 ... +150 °C	+20 ... +150 °C
	Operation	0 ... +150 °C	0 ... +150 °C	0 ... +150 °C
Pressure resistance		100 bar (front)	-	20 bar (front)
Protection class (DIN EN 60529)		IP64 (plugged)	IP64 (plugged)	IP64 (plugged)
Material		stainless steel	stainless steel and ceramics	stainless steel and plastic

¹⁾ Valid for operation with DT3300 controller, referred to nominal measuring range

²⁾ Relates to mid of measuring range

³⁾ RMS value of the signal noise, static (25 Hz)

⁴⁾ Higher values possible with TCS option

⁵⁾ Length tolerance of cable: ±10 %

▲▲▲▲
Measurement direction

▲
Connector side

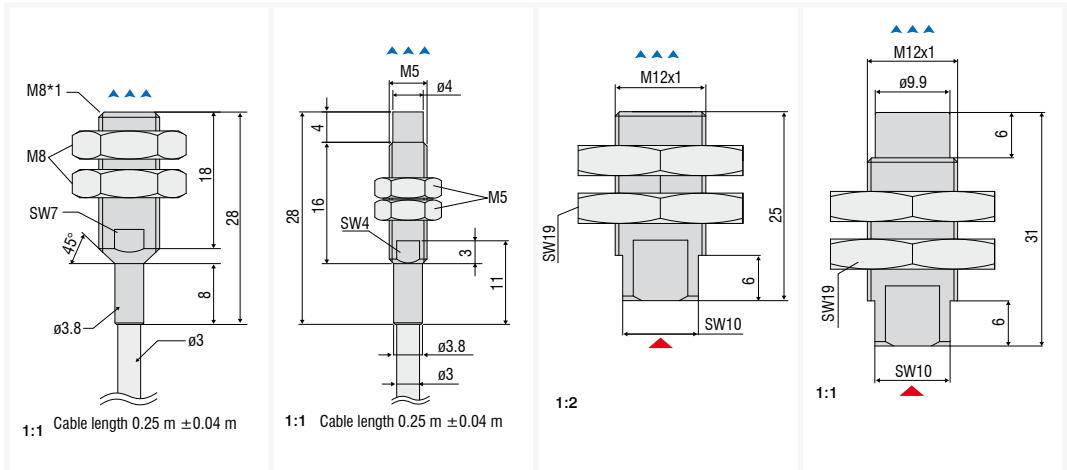

Model	ES1	EU1	ES2	EU3
Measuring range	1 mm	1 mm	2 mm	3 mm
Start of measuring range	0.1 mm	0.1 mm	0.2 mm	0.3 mm
Resolution ^{1) 2) 3)}	0.05 µm	0.05 µm	0.1 µm	0.15 µm
Linearity ¹⁾	< ±2 µm	< ±2 µm	< ±4 µm	< ±6 µm
Temperature stability ^{1) 2) 4)}	< 0.15 µm / K	< 0.15 µm / K	< 0.3 µm / K	< 0.45 µm / K
Temperature compensation ⁴⁾	0 ... +90 °C	0 ... +90 °C	0 ... +90 °C	0 ... +90 °C
Min. target size (flat)	Ø 12 mm	Ø 15 mm	Ø 18 mm	Ø 36 mm
Sensor type	shielded	unshielded	shielded	unshielded
Connection	integrated cable, axial, length approx. 0.25 m ⁵⁾	integrated cable, axial, length approx. 0.25 m ⁵⁾	Plug connection via triaxial socket	Plug connection via triaxial socket
Mounting	Cable gland (M8)	Cable gland (M5)	Cable gland (M12)	Cable gland (M12)
Temperature range	Storage	+20 ... +150 °C	+20 ... +150 °C	+20 ... +150 °C
	Operation	0 ... +150 °C	-40 ... +150 °C	-20 ... +150 °C
Pressure resistance	-	-	20 bar (front)	20 bar (front)
Protection class (DIN EN 60529)	IP64 (plugged)	IP50 (plugged)	IP64 (plugged)	IP64 (plugged)
Material	stainless steel and plastic	stainless steel and plastic	stainless steel and plastic	stainless steel and plastic

¹⁾ Valid for operation with DT3300 controller, referred to nominal measuring range

²⁾ Relates to mid of measuring range

³⁾ RMS value of the signal noise, static (25 Hz)

⁴⁾ Higher values possible with TCS option

⁵⁾ Length tolerance of cable: ±10 %

▲▲▲▲
Measurement direction

▲
Connector side

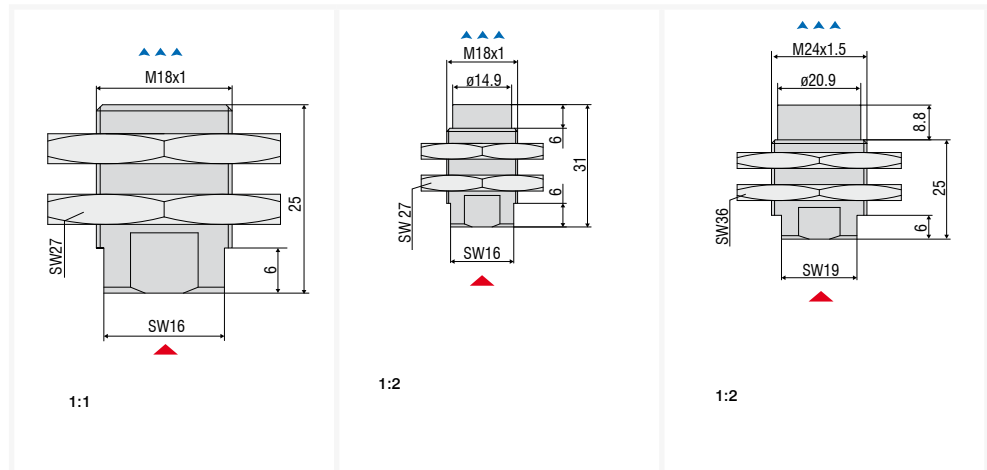

Model		ES4	EU6	EU8
Measuring range		4 mm	6 mm	8 mm
Start of measuring range		0.4 mm	0.6 mm	0.8 mm
Resolution ^{1) 2) 3)}		0.2 μm	0.3 μm	0.4 μm
Linearity ¹⁾		< $\pm 8 \mu\text{m}$	< $\pm 12 \mu\text{m}$	< $\pm 16 \mu\text{m}$
Temperature stability ^{1) 2) 4)}		< 0.6 $\mu\text{m} / \text{K}$	< 0.9 $\mu\text{m} / \text{K}$	< 1.2 $\mu\text{m} / \text{K}$
Temperature compensation ⁴⁾		0 ... +90 °C	0 ... +90 °C	0 ... +90 °C
Min. target size (flat)		$\varnothing 27 \text{ mm}$	$\varnothing 54 \text{ mm}$	$\varnothing 72 \text{ mm}$
Sensor type		shielded	unshielded	unshielded
Connection		Plug connection via triaxial socket	Plug connection via triaxial socket	Plug connection via triaxial socket
Mounting		Cable gland (M18)	Cable gland (M18)	Cable gland (M24)
Temperature range	Storage	+20 ... +150 °C	+20 ... +150 °C	+20 ... +150 °C
	Operation	0 ... +150 °C	-20 ... +150 °C	0 ... +150 °C
Pressure resistance		20 bar (front)	20 bar (front)	20 bar (front)
Protection class (DIN EN 60529)		IP50 (plugged)	IP64 (plugged)	IP64 (plugged)
Material		stainless steel and plastic	stainless steel and plastic	stainless steel and plastic

¹⁾ Valid for operation with DT3300 controller, referred to nominal measuring range

²⁾ Relates to mid of measuring range

³⁾ RMS value of the signal noise, static (25 Hz)

⁴⁾ Higher values possible with TCS option

▲▲▲▲
Measurement direction

▲
Connector side

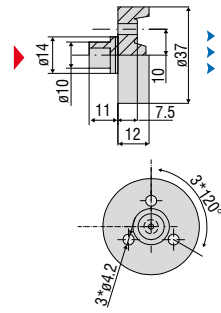

1:3

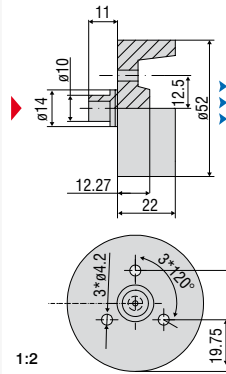

1:2

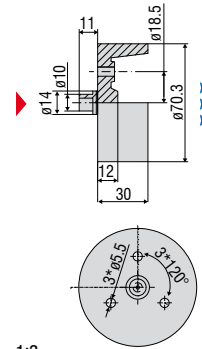

1:3

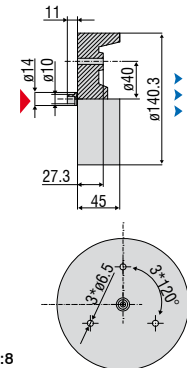

1:8

Model	EU15	EU22	EU40	EU80
Measuring range	15 mm	22 mm	40 mm	80 mm
Start of measuring range	1.5 mm	2.2 mm	4 mm	8 mm
Resolution ^{1) 2) 3)}	0.75 μm	1.1 μm	2 μm	4 μm
Linearity ¹⁾	< $\pm 30 \mu\text{m}$	< $\pm 44 \mu\text{m}$	< $\pm 80 \mu\text{m}$	< $\pm 160 \mu\text{m}$
Temperature stability ^{1) 2) 4)}	< 2.25 $\mu\text{m} / \text{K}$	< 3.3 $\mu\text{m} / \text{K}$	< 6 $\mu\text{m} / \text{K}$	< 12 $\mu\text{m} / \text{K}$
Temperature compensation ⁴⁾	0 ... +90 °C	0 ... +90 °C	0 ... +90 °C	0 ... +90 °C
Min. target size (flat)	$\varnothing 111 \text{ mm}$	$\varnothing 156 \text{ mm}$	$\varnothing 210 \text{ mm}$	$\varnothing 420 \text{ mm}$
Sensor type	unshielded	unshielded	unshielded	unshielded
Connection	Plug connection via triaxial socket	Plug connection via triaxial socket	Plug connection via triaxial socket	Plug connection via triaxial socket
Mounting	3 x through-holes	3 x through-holes	3 x through-holes	3 x through-holes
Temperature range	Storage	+20 ... +150 °C	+20 ... +150 °C	+20 ... +150 °C
	Operation	0 ... +150 °C	0 ... +150 °C	0 ... +150 °C
Protection class (DIN EN 60529)	IP64 (plugged)	IP64 (plugged)	IP64 (plugged)	IP64 (plugged)
Material	epoxy	epoxy	epoxy	epoxy

¹⁾ Valid for operation with DT3300 controller, referred to nominal measuring range

²⁾ Relates to mid of measuring range

³⁾ RMS value of the signal noise, static (25 Hz)

⁴⁾ Higher values possible with TCS option

Connection cables for DT3300 portfolio sensors

Sensors with integrated cable: cable types ECx + ESx or EUx

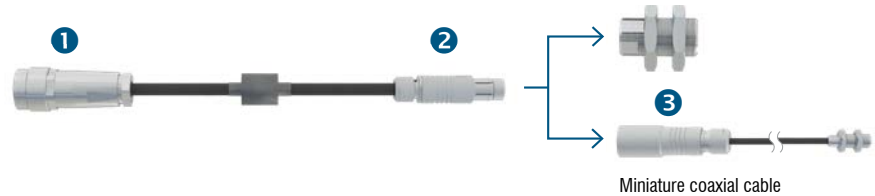

Special coaxial cable

Coaxial cable with Viton sheathing

Cable diameter: Ø 3.6 mm

Minimum bending radius: static approx. 18 mm / dynamic approx. 36 mm

Temperature resistance: up to 200 °C (3000 hrs.)

Available length: 1 m / 3 m / 6 m (9 m on request)

Sensors with integrated cable and open ends for solder connection via adapter cable ECx/1



Special coaxial cable

Coaxial cable with Viton sheathing

Cable diameter: Ø 3.6 mm

Minimum bending radius: static approx. 18 mm / dynamic approx. 36 mm

Temperature resistance: up to 200 °C (3000 hrs.)

Available length: 1 m / 3 m / 6 m (9 m on request)

Sensors with integrated cable and A0 plug via adapter cable ECx/2



Special coaxial cable

Coaxial cable with Viton sheathing

Cable diameter: Ø 3.6 mm

Minimum bending radius: static approx. 18 mm / dynamic approx. 36 mm

Temperature resistance: up to 200 °C (3000 hrs.)

Available length: 1 m / 3 m / 6 m (9 m on request)



Plug/Socket

1 **5-pole socket 0323109:** series 712

Type: 5 poles
Connection: screwed connector
Temperature resistance: 85 °C



2 **Triax plug 0323253:** Type SE102 A014-120 D4,9

Triaxial plug: Type: mB0
Connection: push-pull
Temperature resistance: 200 °C (3000 hrs.)



3 **Triax socket 0323121:** Type KE102 A014-120 D2,1

Triaxial socket: Type: fB0
Connection: push-pull
Temperature resistance: 200 °C (3000 hrs.)



4 **Triax plug 0323174:** Type S101 A005-120 D4,1

Triaxial plug: Type: mA0
Connection: push-pull
Temperature resistance: 200 °C (3000 hrs.)



5 **Triax socket 0323173**

Triaxial socket: Type: fA0
Connection: push-pull
Temperature resistance: 200 °C (3000 hrs.)



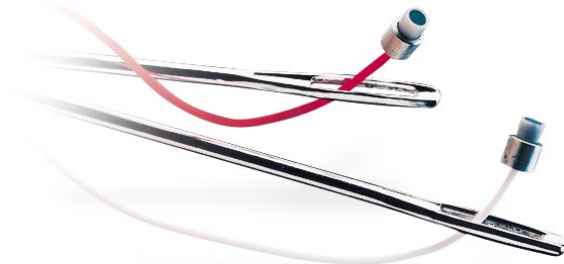

Subminiature sensors for restricted spaces

As well as standard sensors in conventional designs, miniature sensors with the smallest possible dimensions that achieve high precision measurement results are also available. Pressure-resistant versions, screened housings, ceramic types and other special features characterize these sensors, which achieve highly accurate measurement results despite their small dimensions. These miniature sensors are primarily used in high pressure applications, for example, in combustion engines.

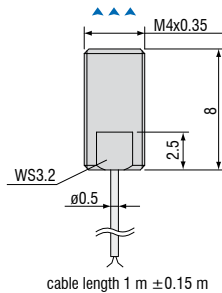

ES04/180(25) Shielded Sensor

Measuring range 0.4 mm
 Temperature stability $\leq \pm 0.025\%$ FSO/°C
 Connection: integrated coaxial cable 1 m ($\varnothing 0.5$ mm), short silicon tube at cable exit
 Pressure resistance (static): front 100 bar
 Max. operating temperature: 180 °C
 Housing material: stainless steel
 Sensor cable: ECx/1 or ECx/2, length ≤ 6 m

2:1

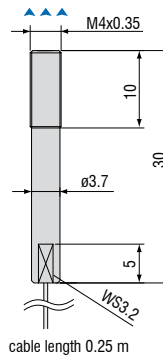

ES04/180(27) Shielded Sensor

Measuring range 0.4 mm
 Temperature stability $\leq \pm 0.025\%$ FSO/°C
 Connection: integrated coaxial cable 0.25 m ($\varnothing 0.5$ mm) with solder connection board
 Pressure resistance (static): front 100 bar
 Max. operating temperature: 180 °C
 Housing material: stainless steel
 Sensor cable: ECx/1, length ≤ 6 m

1:1

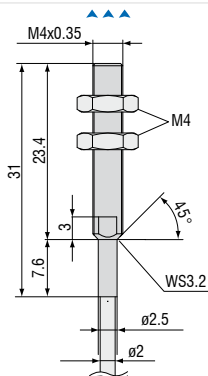

ES04(34) Shielded Sensor

Measuring range 0.4 mm
 Temperature stability $\leq \pm 0.025\%$ FSO/°C
 Connection: integrated coaxial cable 0.25 m ($\varnothing 2$ mm) with sealed triaxial connector
 Pressure resistance (static): front 100 bar / rear side splash water
 Max. operating temperature: 150 °C
 Housing material: stainless steel and ceramic
 Sensor cable: ECx, length ≤ 6 m

1:1

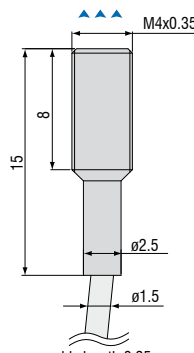
cable length 0.25 m ± 0.04 m

ES04(35) Shielded Sensor

Measuring range 0.4 mm
 Temperature stability $\leq \pm 0.025\%$ FSO/°C
 Connection: integrated coaxial cable 0.25 m ($\varnothing 1.5$ mm) with sealed triaxial connector
 Pressure resistance (static): front 100 bar / rear side 5 bar
 Max. operating temperature: 150 °C
 Housing material: stainless steel and ceramic
 Sensor cable: ECx/1, length ≤ 6 m

2:1

cable length 0.25 m

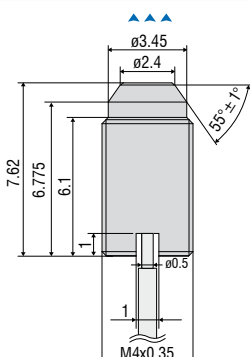

ES04(70) Shielded Sensor

Measuring range 0.4 mm
 Temperature stability $\leq \pm 0.025\%$ FSO/°C
 Connection: integrated coaxial cable 0.25 m ($\varnothing 0.5$ mm) with solder connection board
 Pressure resistance (static): front 100 bar / rear side splash water
 Max. operating temperature: 150 °C
 Housing material: stainless steel and ceramic
 Sensor cable: ECx/1, length ≤ 6 m

3:1

cable length 0.25 m

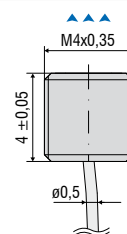

ES04/180(102) Shielded Miniature Sensor

Measuring range 0.4 mm
 Temperature stability $\leq \pm 0.025\%$ FSO/°C
 Connection: integrated coaxial cable 0.8 m ($\varnothing 0.5$ mm) with solder connection board
 Pressure resistance (static): front 100 bar / rear side splash water
 Max. operating temperature: 150 °C
 Housing material: stainless steel and ceramic
 Sensor cable: ECx/1, length ≤ 6 m

3:1

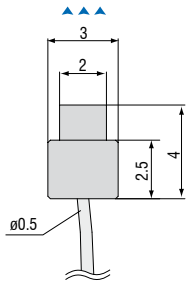

EU05(10) Unshielded Sensor
 Measuring range 0.5 mm
 Temperature stability $\leq \pm 0.025\%$ FSO/°C
 Connection: integrated coaxial cable 0.25 m (\varnothing 0.5 mm) with solder connection board
 Max. operating temperature: 150 °C
 Housing material: stainless steel and ceramic
 Sensor cable: ECx/1, length \leq 6 m

cable length 0.25 m \pm 0.04 m

3:1

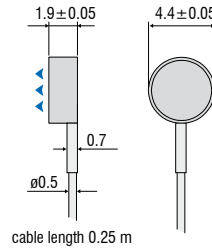

ES05/180(16) Shielded Sensor
 Measuring range 0.5 mm
 Temperature stability $\leq \pm 0.025\%$ FSO/°C
 Connection: integrated coaxial cable 0.25 m (\varnothing 0.5 mm) with solder connection board
 Max. operating temperature: 180 °C
 Housing material: stainless steel and epoxy
 Sensor cable: ECx/1, length \leq 6 m

3:1

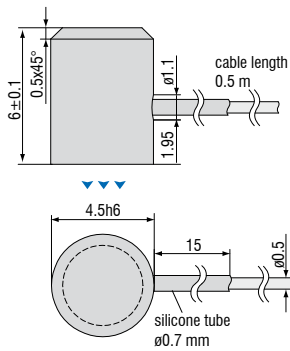

ES05(36) Shielded Sensor
 Measuring range 0.5 mm
 Connection: integrated coaxial cable 0.5 m (\varnothing 0.5 mm) with solder connection board
 Max. operating temperature: 150 °C
 Housing material: stainless steel and epoxy
 Sensor cable: ECx/1, length \leq 6 m

3:1

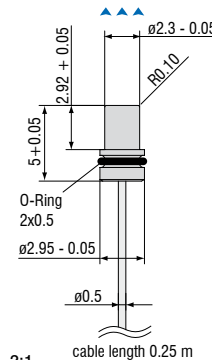

EU05(65) Unshielded Sensor
 Measuring range 0.5 mm
 Connection: integrated coaxial cable 0.25 m (\varnothing 0.5 mm) with solder connection board
 Pressure resistance (static): front 700 bar / rear side splash water
 Max. operating temperature: 150 °C
 Housing material: ceramic
 Sensor cable: ECx/1, length \leq 6 m

2:1

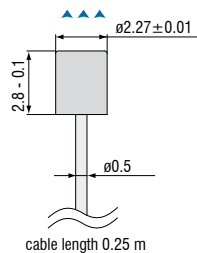

EU05(66) Unshielded Sensor
 Measuring range 0.5 mm
 Temperature stability $\leq \pm 0.025\%$ FSO/°C
 Connection: integrated coaxial cable 0.25 m (\varnothing 0.5 mm) with solder connection board
 Pressure resistance (static): front 400 bar / rear side splash water
 Max. operating temperature: 150 °C
 Housing material: ceramic
 Sensor cable: ECx/1, length \leq 6 m

3:1

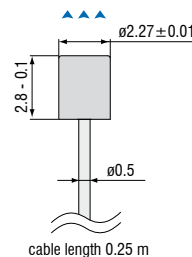

EU05(72) Unshielded Sensor
 Measuring range 0.4 mm
 Temperature stability $\leq \pm 0.025\%$ FSO/°C
 Connection: integrated coaxial cable 0.25 m (\varnothing 0.5 mm) with solder connection board
 Pressure resistance (static): front 2000 bar / rear side splash water
 Max. operating temperature: 150 °C
 Housing material: ceramic
 Sensor cable: ECx/1, length \leq 6 m

3:1

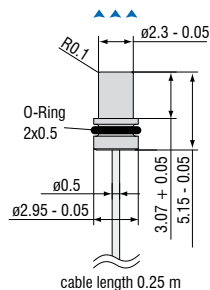

EU05(93) Unshielded Sensor
 Measuring range 0.4 mm
 Temperature stability $\leq \pm 0.025\%$ FSO/°C
 Connection: integrated coaxial cable 0.25 m (\varnothing 0.5 mm) with solder connection board
 Pressure resistance (static): front 2000bar / rear side splash water
 Max. operating temperature: 150 °C
 Housing material: ceramic
 Sensor cable: ECx/1, length \leq 6 m

2:1

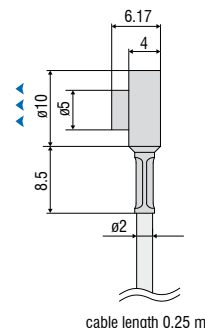

EU1FL Unshielded flat sensor
 Measuring range 1 mm
 Temperature stability $\leq \pm 0.025\%$ FSO/°C
 Connection: integrated coaxial cable 0.25 m (\varnothing 2 mm) with sealed triaxial connector
 Max. operating temperature: 150 °C
 Housing material: stainless steel and epoxy
 Sensor cable: ECx

1:1

Article	Description	DT3001	DT3005	DT3060	DT3070	DT3300	DZ140	SGS
PCx/8-M12	Supply and signal cable 8-pole with M12 connector Standard length: 3 m Optionally available: 5 m / 10 m / 15 m / 10 m as drag-chain suitable variant			x	x			
PCx/5-M12	Supply and signal cable 5-pole with M12 connector Standard length: 5 m Optionally available: 20 m	x	x					
PC4701-x	Supply and signal cable 8-pole with M12 connector Standard length: 10 m Optionally available: 15 m / 10 m as drag-chain suitable variant							x
SCD2/4/RJ45	Ethernet cable 4-pole with M12 connector on RJ45 connector Standard length: 2 m			x	x			
SCAx/5	Signal cable, analog 5-pole with M16x0.75 connector Standard length: 3 m Optionally available: 6 m / 9 m					x		
SCDx/8	Signal cable for switching inputs and outputs: 8-pole with M16x0.75 connector Standard length: 0.3 m Optionally available: 1 m					x		
PSCx	Supply and synchronization cable 5-pole with M9 connector Standard length: 0.3 m Optionally available: 1 m					x		
ESCx	Synchronization cable 5-pole with M9 connector Standard length: 0.3 m Optionally available: 1 m					x		
PC140-x	Supply and signal cable 8-pole connector Standard length: 3 m Optionally available: 6 m						x	
PS2020	Power supply unit Input 100-240 VAC output 24 VDC / 2.5 A; mounting onto symmetrical standard rail 35 mm x 7.5 mm, DIN 50022	x	x	x	x	x	x	x

Sensors and Systems from Micro-Epsilon

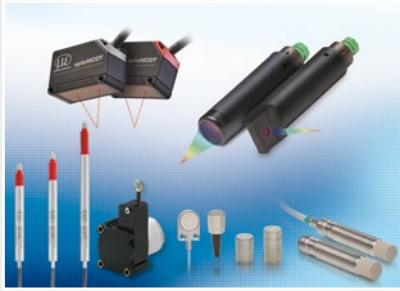

Sensors and systems for displacement, distance and position



Sensors and measurement devices for non-contact temperature measurement



Measuring and inspection systems for metal strips, plastics and rubber

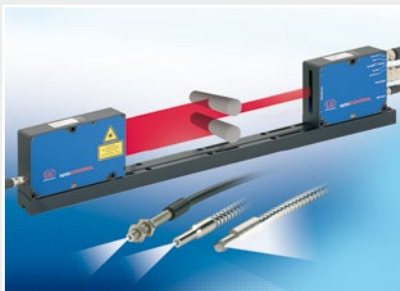

Optical micrometers and fiber optics, measuring and test amplifiers



Color recognition sensors, LED analyzers and inline color spectrometers



3D measurement technology for dimensional testing and surface inspection