



More Precision

capa**N**CDT // Capacitive displacement sensors and systems





- Multi-channel system with sub-nanometer precision resolution
- Virtually independent of temperature
- Also measures against insulators
- As benchtop unit and as card carrier for a 19-inch format
- Integrated calculation function for thickness measurements
- Numerous filters, averaging, trigger functions, measured value storage, digital linearization

System design

The capaNCDT 6500 can be used for multi-channel operation and is modular in its design. Up to eight sensors can be connected to the signal conditioning electronics (Euro-size cards) via a preamplifier module.

For the DL6530 version, the pre-amplifier is integrated in the housing and is used for cable lengths up to 4 m (with CC cable) or 8 m (with CCg cable). For longer cable lengths, the external preamplifiers CP6001 or CPM6011 are used.

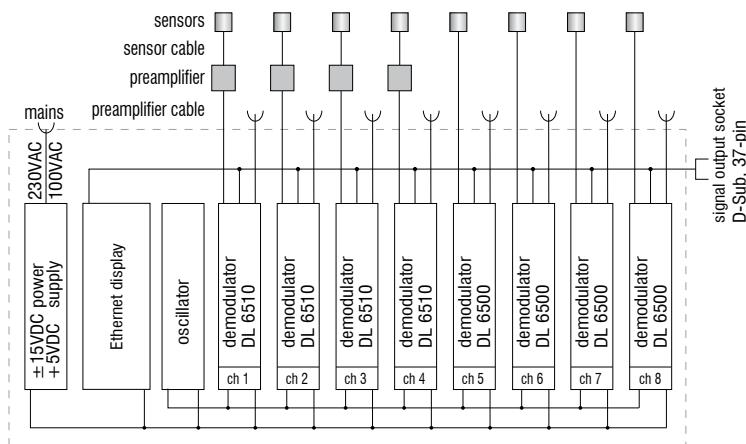

A measuring system with n measurement channels consists of:

1. controller DT6530 with power supply, display, Ethernet, oscillator and analog output
2. n x demodulator modules DL6510 (DL6530 with integral pre-amplifier)
3. n x pre-amplifier connecting cables
4. n x pre-amplifier modules CP6001
5. n x sensor cables
6. n x sensors

DL6510: One item of position 2 to 6 is needed for each channel.

DL6530: One item of position 2, 5 and 6 is needed for each channel.

Web interface

The web interface for controller configuration opens via Ethernet.
Up to 8 channels can be visualized and linked arithmetically.

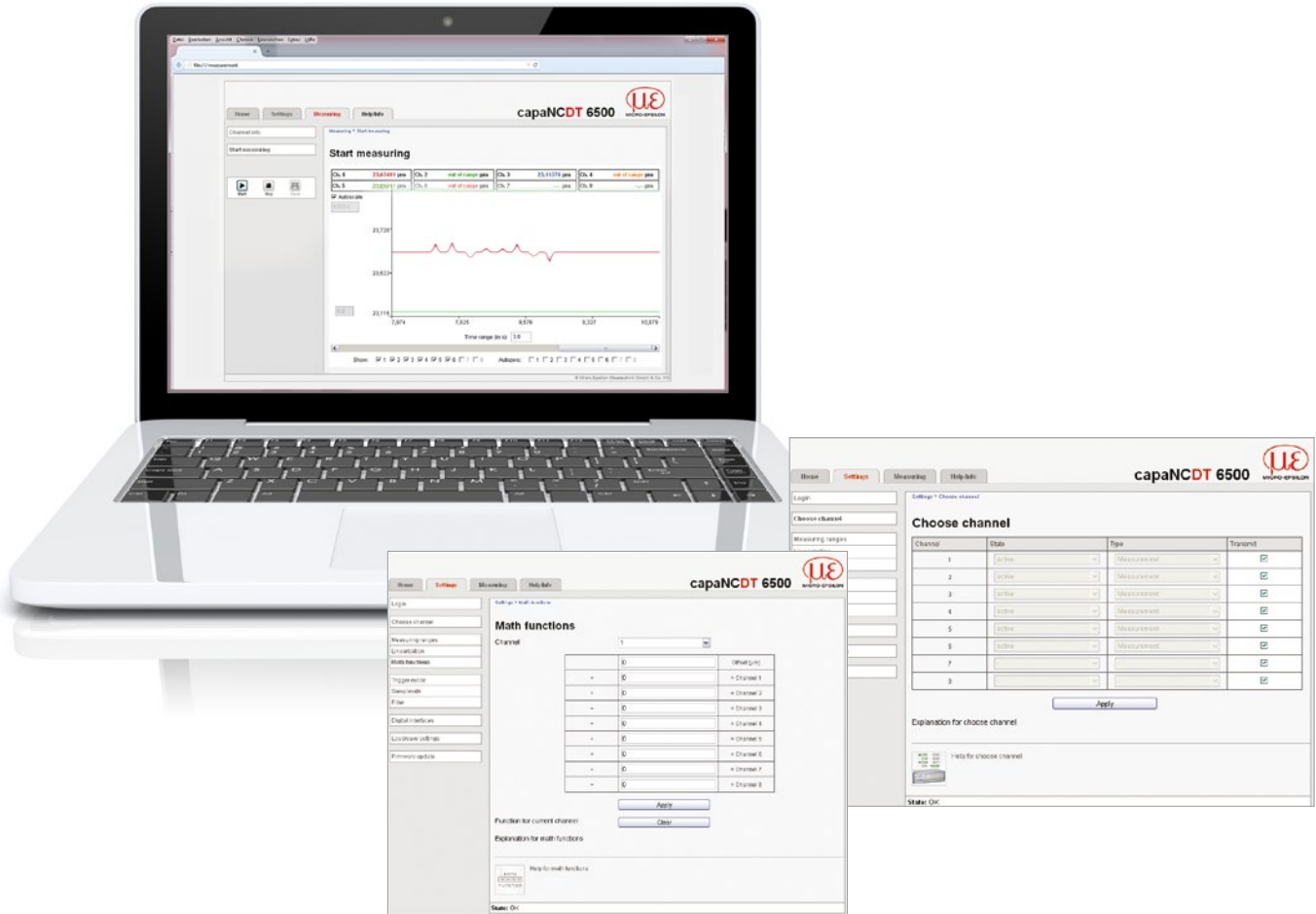

System configuration

System capaNCDT 6500 (with integral pre-amplifier):

- DT6530 / DT6530C Rack
- Demodulator DL6530
- Sensor cable
- Sensor



CPM6011
External pre-amplifier for standard measurements



CP6001
External pre-amplifier for high precision measurements

System capaNCDT 6510 (with external pre-amplifier):

- DT6530 / DT6530C Rack
- Demodulator DL6510
- Sensor cable
- Sensor
- Pre-amplifier CPM6011 / CP6001
- Pre-amplifier cable



DT6530C 2 channel rack



DT6530 8 channel rack

Controller DT6530 8-channel rack

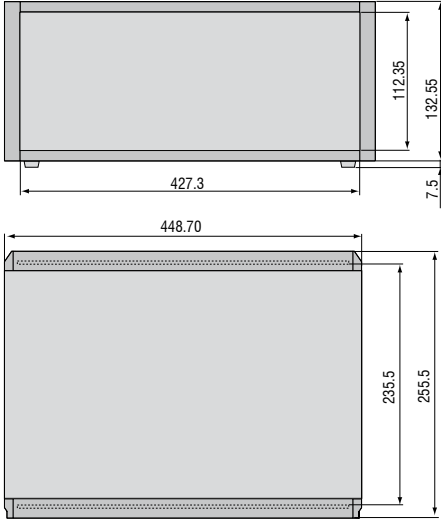

Controller DT6530C 2-channel rack



CPM6011 capacitive pre-amplifier

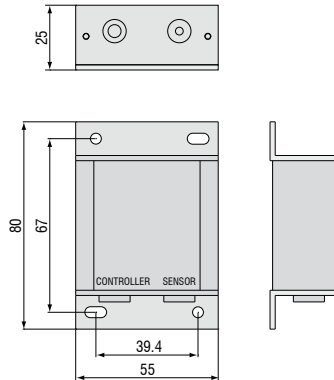

DL6530/6510 front cover

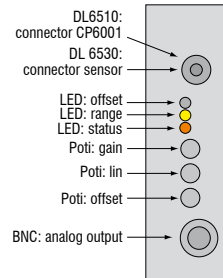

CP6001 capacitive pre-amplifier

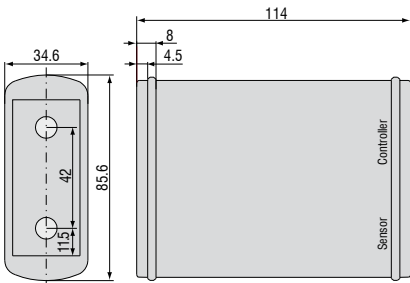

Mounting adapter CP6001

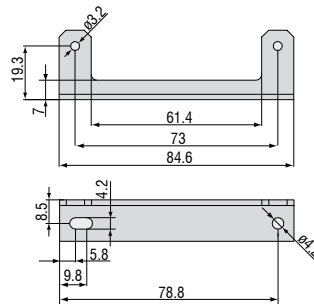

Pre-amplifier cable CA5 / CAx

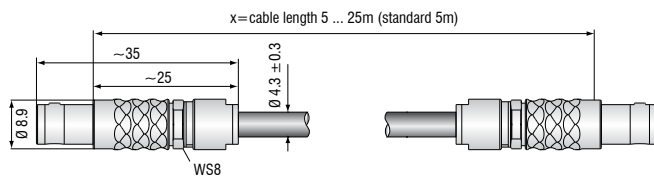

Controller type	DT6530	DT6530 with pre-amplifier CPM6011
Resolution static ¹⁾	0.000075 % FSO	0.0006 % FSO
Resolution dynamic ¹⁾	0.002 % FSO (8.5 kHz)	0.015 % FSO (8.5kHz)
Data rate analog output	8.5 kHz (-3 dB)	8.5 kHz (-3 dB)
Bandwidth (switchable)	20 Hz; 1 kHz; 8.5 kHz	20 Hz; 1 kHz; 8.5 kHz
Data rate digital output	4 x 7.8 kSa/s; 8 x 3.9 kSa/s	4 x 7.8 kSa/s; 8 x 3.9 kSa/s
Linearity (typ.)	≤ ±0.025 % FSO	≤ ±0.05 % FSO
Max. sensitivity deviation	≤ ±0.05 % FSO	≤ ±0.1 % FSO
Repeatability	0.0003 % FSO	0.001 % FSO
Long-term stability	±0.002 % FSO / month	±0.02 % FSO / month
Synchronous operation	yes	yes
Insulator measurement	yes	no
Temperature stability	±digital: 5 ppm/°C analog: 10 ppm/°C	80 ppm
Temperature range (during operation)	Sensor	-50 ... + 200 °C
	Controller	+10 ... +60 °C
Temperature range (storage)	-10 ... +75 °C	-10 ... +75 °C
Supply	230 VAC	230 VAC
Output	0 ... 10 V (max. 10 mA short circuit proof);	0 ... 10 V (max. 10 mA short circuit proof);
	4 ... 20 mA (load max. 500 Ω)	4 ... 20 mA (load max. 500 Ω)
	optional: 0 ... 20 mA (load max. 500 Ω)	optional: 0 ... 20 mA (load max. 500 Ω)
	Ethernet 24 Bit; EtherCAT	Ethernet 24 Bit; EtherCAT
Sensors	suitable for all sensors	suitable for all sensors
Sensor cable standard	CC cable ≤ 1 m CCm cable = 1.4 m CCg cable = 2 m	CC cable ≤ 1 m CCm cable = 1.4 m CCg cable = 2 m
Sensor cable (special tuning)	double / triple / quadruple standard cable length	double / triple / quadruple standard cable length
Trigger	TTL, 5 V	TTL, 5 V
No. of channels	max. 8	max. 8

FSO = Full Scale Output

¹⁾ RMS noise related to mid of measuring range

Options		
Article number	Description	Description
2982011	EMR2 CP6001	extended measuring range (factor: 2) in combination with DL6510
2982013	RMR 1/2 CP6001	reduced measuring range (factor: 1/2) in combination with DL6510
2982015	ECL2 CP6001	special tuning for double standard cable length in combination with DL6510
2982017	ECL3 CP6001	special tuning for triple standard cable length in combination with DL6510
2982026	ECL4 CP6001	special tuning for quadruple standard cable length in combination with DL6510
2982028	ECL2 CPM6011	special tuning for 2 m sensor cable in combination with DL6510
2982019	EMR2 DL65x0	extended measuring range (factor: 2)
2982020	RMR 1/2 DL65x0	reduced measuring range (factor: 1/2)
2982021	ECL2 DL65x0	special tuning for double standard cable length
2982023	ECL3 DL65x0	special tuning for triple standard cable length
2982025	ECL4 DL65x0	special tuning for 4 m sensor cable
2982033	EMR2 CPM6011	extended measuring range (factor: 2)

Sensor cable	Cable CCx,x / CCx,x/90	Cable CCmx,x / CCmx,x/90	Cable CCgx,x / CCgx,x/90
Description	Low-outgassing cable up to 4 m length, for applications in clean rooms	Low-outgassing cable up to 4.2 m length, for applications in clean rooms, UHV and EUV	Robust cable up to 8 m length, for industrial applications
Temperature stability	-100 °C to +200 °C	-100 °C to +200 °C	-20 °C to +80 °C (permanent) -20 °C to +100 °C (10;000 h)
Outer diameter	3.1 mm ±0.1 mm	2.1 mm ±0.1 mm	3.1 mm ±0.1 mm
Bending radius	3x cable diameter during installation; 7x cable diameter for movement; 12x cable diameter recommend at continuous movement		

Design	Cable with connector type C for sensors CS005 / CS02 / CS05 / CSE05 / CS08 / CSE1						Cable with connector type B for sensors CS1 / CS1HP / CSE1,25 / CS2 / CSE2 / CS3 / CSE3 / CS5 / CS10					
	2 x straight connector			1 x straight / 1 x 90° connector			2 x straight connector			1 x straight / 1 x 90° connector		
Model	CCx,xC	CCmx,xC	CCgx,xC	CCx,xC/90	CCmx,xC/90	CCgx,xC/90	CCx,xB	CCmx,xB	CCgx,xB	CCx,xB/90	CCmx,xB/90	CCgx,xB/90
Standard 1 m	•		•	•		•	•		•	•		•
1.4 m		•			•			•			•	
2 m	•		•	•		•	•		•	•		•
2.8 m		•			•			•			•	
3 m	•			•			•		•	•		
4 m			•			•		•				•
4.2 m		•			•			•			•	
6 m			•			•			•			•
8 m			•			•			•			•

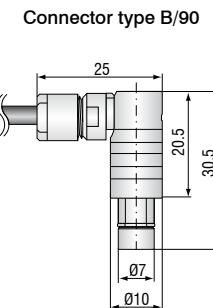
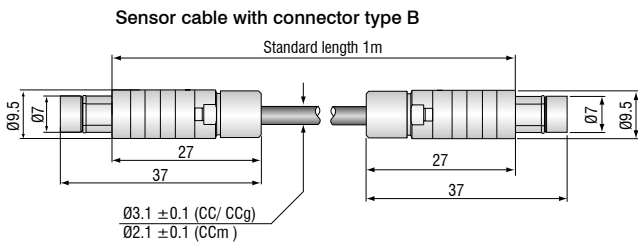
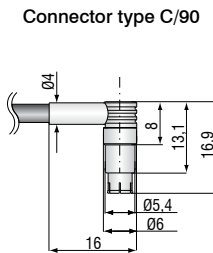
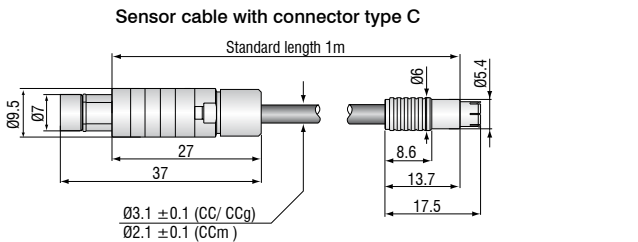

Accessories	capaNCDT	6110	6200	6500
MC2.5 Micrometer for sensor calibration, range 0 - 2.5 mm, Resolution 0.1 µm. Suitable for sensors CS005 to CS2		•	•	•
MC25D Digital micrometer for sensor calibration, range 0 - 25 mm, adjustable offset (zero). Suitable for all sensors.		•	•	•
HV/B Vacuum feed through triaxial		•	•	•
UHV/B Vacuum feed through triaxial for ultra-high vacuum		•	•	•
PC6200-3/4 Power-/trigger cable, 4 pin, 3 m			•	
SCAC3/4 Signal output cable, (necessary for multi-channel applications), 4 pin, 3 m			•	
SCAC3/5 Signal output cable, analog, 5 pin, 3 m		•		
SC6000-1,0 Synchronization cable, 5 pin, 1 m			•	•
CA5 Preampifier cable 5 pin, 5 m				•
PS2020 Power supply for DIN rail mounting; Input 230 VAC (115 VAC); Output 24 VDC / 2.5 A; L/W/H 120x120x40 mm		•	•	

HV/B Vacuum feed through (Art.-no. 0323050)

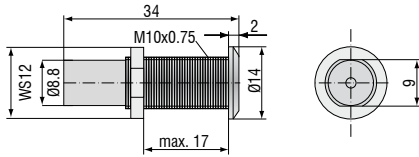

Max. leak rate 1×10^{-7} mbar · l s⁻¹, compatible with connector type B

UHV/B Vacuum feed triax weldable (Art.-no. 0323346)

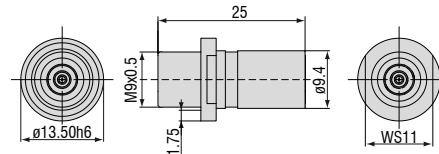

Max. leak rate 1×10^{-9} mbar · l s⁻¹, compatible with connector type B

UHV/B Vacuum feed triax with flange CF16 (Art.-no. 0323349)

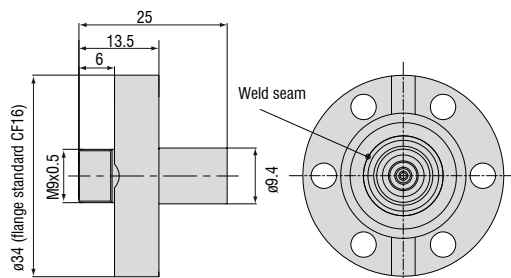

Max. leak rate 1×10^{-9} mbar · l s⁻¹, compatible with connector type B

UHV/B Vacuum feed triax screwable (Art.-no. 0323370)

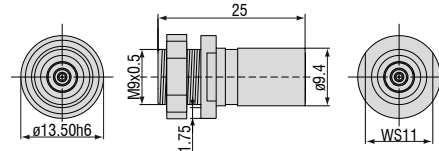

Max. leak rate 1×10^{-9} mbar · l s⁻¹, compatible with connector type B

SCAC3/4 Signal output cable (Art.-no. 2902104)

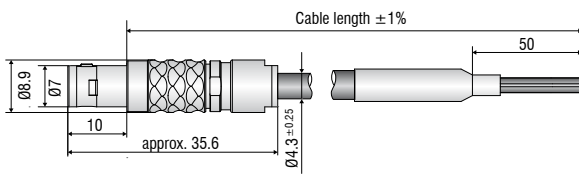

SCAC3/5 Signal output cable (Art.-no. 2902112)

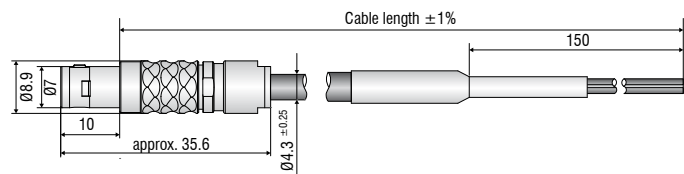

PC6200-3/4 Power-/trigger cable (Art.-no. 2901881)

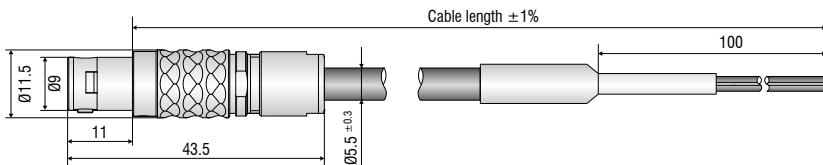

SC6000-1,0 Synchronization cable (Art.-no. 2903473)

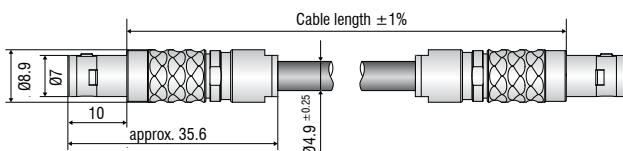

CA5 Preamplifier cable (Art.-no. 2903180)

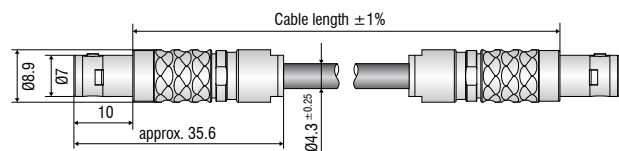

Sensors and Systems from Micro-Epsilon



Sensors and systems for displacement, distance and position



Sensors and measurement devices for non-contact temperature measurement

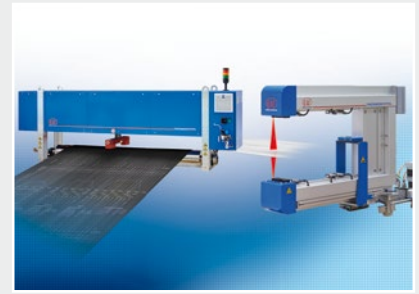

Measuring and inspection systems for metal strips, plastics and rubber

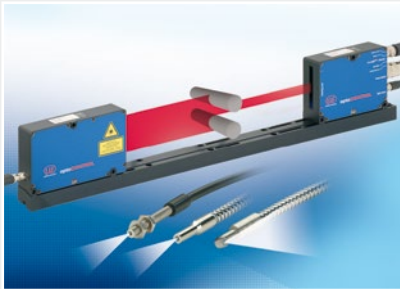

Optical micrometers and fiber optics, measuring and test amplifiers



Color recognition sensors, LED analyzers and inline color spectrometers



3D measurement technology for dimensional testing and surface inspection