



Operating Instructions
confocalDT 2421/2422/2465/2466

IFC2421	IFS2402-0,5	IFS2403-0,4	IFS2404-2	IFS2406-2,5/VAC(003)
IFC2422	IFS2402-1,5	IFS2403-1,5	IFS2404-2(001)	IFS2406/90-2,5/VAC(001)
IFC2421MP	IFS2402/90-1,5	IFS2403/90-1,5	IFS2404/90-2	IFS2406-3
IFC2422MP	IFS2402-4	IFS2403-4	IFS2404/90-2(001)	IFS2406-3/VAC(001)
IFC2465	IFS2402/90-4	IFS2403/90-4	IFS2405-0,3	IFS2406-10
IFC2466	IFS2402-10	IFS2403-10	IFS2405-1	IFS2407-0,1
	IFS2402/90-10	IFS2403/90-10	IFS2405-3	IFS2407-0,1(001)
			IFS2405-6	IFS2407/90-0,3
			IFS2405/90-6	IFS2407-0,8
			IFS2405-10	IFS2407-3
			IFS2405-28	
			IFS2405-30	

Confocal chromatic distance and thickness measurement

MICRO-EPSILON
MESSTECHNIK
GmbH & Co. KG
Koenigbacher Str. 15

94496 Ortenburg / Germany

Tel. +49 (0) 8542 / 168-0
Fax +49 (0) 8542 / 168-90
e-mail info@micro-epsilon.com
www.micro-epsilon.com

confocalDT 2421
confocalDT 2422
confocalDT 2465
confocalDT 2466



EtherCAT® is registered trademark and patented technology,
licensed by Beckhoff Automation GmbH, Germany.

Contents

1.	Safety	8
1.1	Symbols Used	8
1.2	Warnings	8
1.3	Notes on Product Marking	8
	1.3.1 CE Marking	8
	1.3.2 UKCA Marking	9
1.4	Intended Use	9
1.5	Proper Environment	9
2.	Functional Principle, Technical Data	10
2.1	Short Description	10
2.2	Measuring Principle	10
2.3	Glossary	11
2.4	Operating Modes	11
2.5	Sensors	11
2.6	Technical Data	12
3.	Delivery	16
3.1	Unpacking, Included in Delivery	16
3.2	Storage	16
4.	Installation	17
4.1	Controller IFC2421/2422/2465/2466	17
4.2	Controller Operating Elements	18
4.3	Controller LEDs	18
4.4	Electrical Connections Controller	19
	4.4.1 Connection Possibilities	19
	4.4.2 Handling of Pluggable Screw Terminals	19
	4.4.3 Grounding, Shielding	20
	4.4.4 Supply Voltage (Power)	20
	4.4.5 RS422	20
	4.4.6 Ethernet, EtherCAT	21
	4.4.7 Analog Output	21
	4.4.8 Switching Outputs (Digital I/O)	22
	4.4.9 Synchronization (Inputs/Outputs)	23
	4.4.10 Triggering	24
	4.4.11 Encoder Inputs	25
4.5	Sensor Cable, Optical Fiber	26
4.6	Sensors	28
	4.6.1 Dimensions IFS2402 Sensors	28
	4.6.2 Dimensions IFS2403 Sensors	28
	4.6.3 Dimensions IFS2404 Sensors	29
	4.6.4 Dimensions IFS2405 Sensors	30
	4.6.5 Dimensions IFS2406 Sensors	33
	4.6.6 Dimensions IFS2407 Sensors	34
	4.6.7 Start of Measuring Range	36
	4.6.8 Mounting, Installation Bracket	37
	4.6.8.1 General	37
	4.6.8.2 IFS2402 Sensors	37
	4.6.8.3 IFS2403 Sensors	37
	4.6.8.4 IFS2405, IFS2406 and IFS2407 Sensors	38
	4.6.8.5 IFS2404 and IFS2407 Sensors	39
	4.6.8.6 Adjustable Mounting Adapter JMA-xx	39
5.	Operation	40
5.1	Commissioning	40
5.2	Operation Using Ethernet	40
	5.2.1 Requirements	40
	5.2.2 Access via Web Interface	41
5.3	Select a Sensor	42
5.4	Button Multifunction	43
5.5	Dark Reference	43
5.6	Place Target	44
5.7	Measurement Configuration	45
5.8	Video Signal	46
5.9	Signal Quality	48
5.10	Distance Measurement	49
5.11	Load / Save Settings	51
6.	Advanced Settings	52
6.1	Inputs	52
	6.1.1 Synchronization	52
	6.1.2 Encoder Inputs	52
	6.1.2.1 Interpolation	53
	6.1.2.2 Maximum Value	53
	6.1.2.3 Effect on the Reference Track	53
	6.1.2.4 Set on Value	53
	6.1.2.5 Reset Reference Mark	53
	6.1.3 Abschlusswiderstand	54
6.2	Data Recording	54
	6.2.1 Measuring Rate	54

6.2.2	Reset Counter.....	54
6.2.3	Input Triggering.....	55
	6.2.3.1 General.....	55
	6.2.3.2 Triggering Data Recording.....	56
	6.2.3.3 Trigger Time Difference.....	56
6.2.4	Masking the Evaluation Range.....	57
6.2.5	Peaksymmetrie.....	58
6.2.6	Exposure Mode.....	59
6.2.7	Peak Separation.....	60
	6.2.7.1 Detection Threshold.....	60
	6.2.7.2 Peak Modulation.....	60
6.2.8	Peak Selection, Number of Measurement Values.....	62
6.2.9	Material Selection.....	63
6.3	Signal Processing.....	64
6.3.1	Spike Correction.....	64
6.3.2	Calculation.....	65
	6.3.2.1 Data Source, Parameter, Programs.....	65
	6.3.2.2 Definitions.....	66
	6.3.2.3 Measurement Averaging.....	67
6.4	Postprocessing.....	70
6.4.1	Calculation.....	70
	6.4.1.1 Data Source, Parameter, Programs.....	70
	6.4.1.2 Definitions.....	71
	6.4.1.3 Measurement Averaging.....	71
6.4.2	Zeroing, Mastering.....	72
6.4.3	Statistics.....	73
6.4.4	Output Triggering.....	74
	6.4.4.1 General.....	74
	6.4.4.2 Triggering Data Output.....	75
6.4.5	Data Reduction, Output Data Rate.....	75
6.4.6	Error Handling (Hold Last Value).....	75
6.5	Outputs.....	76
6.5.1	Digital Interfaces.....	76
	6.5.1.1 RS422.....	76
	6.5.1.2 Ethernet.....	76
	6.5.1.3 Data Output RS422, Ethernet.....	77
6.5.2	Analog Output.....	78
	6.5.2.1 Calculation of the Measurement Value at the Current Output.....	79
	6.5.2.2 Calculation of the Measurement Value at the Voltage Output.....	79
	6.5.2.3 Characteristics Distance Value and Analog Output.....	80
6.5.3	Error Output, Switching Output.....	81
	6.5.3.1 Assignment of the Switch Outputs (digital I/O).....	81
	6.5.3.2 Limit Value Settings.....	81
	6.5.3.3 Switching Logic of Error Outputs.....	81
6.5.4	Output Interface.....	82
6.6	System Settings.....	82
6.6.1	Unit Website, Language.....	82
6.6.2	Key Lock.....	82
6.6.3	Load and Safe.....	82
6.6.4	Access Authorization.....	82
6.6.5	Reset Controller.....	83
6.6.6	Light Source.....	83
6.6.7	Change Ethernet to EtherCAT.....	83
7.	Thickness Measurement.....	84
7.1	One Sensor, Transparent Target.....	84
	7.1.1 Requirements.....	84
	7.1.2 Preset.....	84
	7.1.3 Material Selection.....	84
	7.1.4 Video Signal.....	84
	7.1.5 Signal Processing.....	85
	7.1.6 Measurement Chart.....	86
7.2	Thickness Measurement with Two Sensors.....	86
	7.2.1 Requirements.....	86
	7.2.2 Preset.....	87
	7.2.3 Video Signal.....	87
	7.2.4 Postprocessing.....	87
	7.2.5 Measurement Chart.....	88
8.	Errors, Repair.....	89
8.1	Web Interface Communication.....	89
8.2	Changing the Sensor Cable for IFS2405 and IFS2406 Sensor.....	89
8.3	Changing the Protective Glass for IFS2405 and IFS2406 Sensors.....	89
	8.3.1 IFS2405/IFS2406.....	89
	8.3.2 IFS2406/90-2,5.....	90
9.	Software Update.....	91
10.	Software Support with MEDAQLib.....	91
11.	Disclaimer.....	92
12.	Service, Repair.....	92
13.	Decommissioning, Disposal.....	93

Appendix	94
A 1 Accessories, Services	94
A 1.1 Accessories.....	94
A 1.2 Services:	95
A 2 Factory Settings	95
A 3 Adjustable Mounting Adapter JMA-xx	96
A 3.1 Functions	96
A 3.2 Sensor Mounting, Compatibility.....	96
A 3.3 Assembly	96
A 3.4 Dimensional Drawing of Mounting Adapter	96
A 3.5 Perpendicular Alignment of Sensor.....	97
A 4 Cleaning Optical Components	98
A 4.1 Contamination	98
A 4.2 Tools and Cleaning Agents.....	99
A 4.3 Protective Glass of Sensor	99
A 4.4 Interface between Controller and Sensor Cable.....	100
A 4.5 Interface between Sensor Cable and Sensor	101
A 4.6 Preventive Protection.....	101
A 5 ASCII Communication with Controller	102
A 5.1 General	102
A 5.2 Commands Overview	102
A 5.3 General Commands	106
A 5.3.1 General	106
A 5.3.1.1 Help	106
A 5.3.1.2 Controller Information	106
A 5.3.1.3 Reply Type	106
A 5.3.1.4 Parameter Overview	106
A 5.3.1.5 Synchronization	107
A 5.3.1.6 Termination Resistor at Sync/Trig Input.....	107
A 5.3.1.7 Booting the Sensor	107
A 5.3.1.8 Reset Counter	107
A 5.3.2 Web interface.....	107
A 5.3.2.1 Language	107
A 5.3.2.2 Unit.....	107
A 5.3.3 User Level.....	108
A 5.3.3.1 Changing the User Level	108
A 5.3.3.2 Changing to User Level	108
A 5.3.3.3 Querying the User Level	108
A 5.3.3.4 Defining a Standard User	108
A 5.3.3.5 Changing the Password	108
A 5.3.4 Sensor	108
A 5.3.4.1 Info about Calibration Tables	108
A 5.3.4.2 Sensor Number.....	108
A 5.3.4.3 Sensor Information	109
A 5.3.4.4 Dark Reference	109
A 5.3.4.5 Warning Threshold in the Event of Contamination	109
A 5.3.4.6 LED.....	109
A 5.3.5 Triggering.....	109
A 5.3.5.1 Select Trigger Source	109
A 5.3.5.2 Output of Triggered Values, With/Without Averaging.....	109
A 5.3.5.3 Trigger Type	110
A 5.3.5.4 Active Level Trigger Input	110
A 5.3.5.5 Software Trigger Pulse.....	110
A 5.3.5.6 Number of Output Measurement Values	110
A 5.3.5.7 Trigger Level TrigIn.....	110
A 5.3.5.8 Step Size Encoder Triggering.....	110
A 5.3.5.9 Minimum Encoder Triggering	110
A 5.3.5.10 Maximum Encoder Triggering	110
A 5.3.6 Encoder	111
A 5.3.6.1 Encoder Interpolation Depth	111
A 5.3.6.2 Effect of the Reference Track.....	111
A 5.3.6.3 Encoder Value.....	111
A 5.3.6.4 Setting Encoder Value per Software.....	111
A 5.3.6.5 Reset the Detection of the First Marker Position	111
A 5.3.6.6 Maximum Encoder Value.....	111
A 5.3.7 Interfaces	112
A 5.3.7.1 Ethernet IP Settings	112
A 5.3.7.2 Setting for Ethernet Transmission of Measured Values	112
A 5.3.7.3 Count of Measurements per Ethernet Frame	112
A 5.3.7.4 Setting the RS422 Baud Rate	112
A 5.3.7.5 Change Ethernet / EtherCAT	112
A 5.3.8 Parameter Management, Load / Save Settings	113
A 5.3.8.1 Safe / Load Connection Settings.....	113
A 5.3.8.2 Show Changed Parameters.....	113
A 5.3.8.3 Export of Parameter Sets to PC.....	113
A 5.3.8.4 Import of Parameter Sets from PC.....	113
A 5.3.8.5 Default Settings.....	113
A 5.3.8.6 Safe, Show, Delete Measurement Settings	114

A 5.3.9	Measurement.....	115
	A 5.3.9.1 Number of Peaks	115
	A 5.3.9.2 Peak Selection	115
	A 5.3.9.3 Number of Peaks and Enabling/Disabling Refractive Correction	115
	A 5.3.9.4 Exposure Mode.....	115
	A 5.3.9.5 Measuring Rate.....	115
	A 5.3.9.6 Exposure Time	116
	A 5.3.9.7 Masking the Evaluation Range	116
	A 5.3.9.8 Peak Detection Threshold	116
	A 5.3.9.9 Peak Modulation	116
A 5.3.10	Material Data Base	117
	A 5.3.10.1 Material Table.....	117
	A 5.3.10.2 Select Material.....	117
	A 5.3.10.3 Display Material Properties	117
	A 5.3.10.4 Edit Material Table.....	118
	A 5.3.10.5 Delete a Material	118
	A 5.3.10.6 Material Settings Multilayer Measurement	118
A 5.3.11	Measurement Value Processing.....	119
	A 5.3.11.1 Spike Correction	119
	A 5.3.11.2 Statistics Calculation.....	119
	A 5.3.11.3 List of Signals for the Statistics.....	119
	A 5.3.11.4 Reset the Statistics Calculation	119
	A 5.3.11.5 Selection of a Signal for the Statistics	119
	A 5.3.11.6 List of Possible Signal for the Statistics to be Selected	119
	A 5.3.11.7 List of Signals which can be Parameterized.....	120
	A 5.3.11.8 Master Signal Parameterization	120
	A 5.3.11.9 List of Possible Signals for Mastering.....	120
	A 5.3.11.10 Masters / Zero	120
	A 5.3.11.11 Mastering Example	120
	A 5.3.11.12 Channel Selection.....	122
	A 5.3.11.13 List of possible calculation signals	122
	A 5.3.11.14 Two-Point Scaling Data Outputs.....	122
A 5.3.12	Data Output	123
	A 5.3.12.1 Selection of Digital Output	123
	A 5.3.12.2 Data output Rate	123
	A 5.3.12.3 Reduction Counter of Measurement Value Output	123
	A 5.3.12.4 Error Processing	123
A 5.3.13	Select Measurement Values to be Output	124
	A 5.3.13.1 General.....	124
	A 5.3.13.2 Data selection for Ethernet	124
	A 5.3.13.3 List of Possible Ethernet Signals	124
	A 5.3.13.4 List of Selected Signals, Transfer Sequence via Ethernet.....	124
	A 5.3.13.5 Data selection for RS422	124
	A 5.3.13.6 List of Possible RS422 Signals	124
	A 5.3.13.7 List of Selected Signals, Transfer Sequence via RS422	124
A 5.3.14	Switching Outputs	125
	A 5.3.14.1 Error Switching Outputs	125
	A 5.3.14.2 Setting the Signal to be Evaluated	125
	A 5.3.14.3 List of Possible Signals for Error Output	125
	A 5.3.14.4 Setting Limit Values.....	125
	A 5.3.14.5 Setting Value	125
	A 5.3.14.6 Switching Behavior of Error Outputs	125
A 5.3.15	Analog Output	126
	A 5.3.15.1 Data Selection.....	126
	A 5.3.15.2 List of Possible Signals for Analog Output	126
	A 5.3.15.3 Output range.....	126
	A 5.3.15.4 Setting the Scaling of DAC	126
	A 5.3.15.5 Setting the Scaling Range	126
A 5.3.16	Key Functions	127
	A 5.3.16.1 Multifunction Button	127
	A 5.3.16.2 Signal Selection for Mastering with Multifunction Button.....	128
	A 5.3.16.3 Key Lock.....	128
A 5.4	Measured Value Format.....	129
	A 5.4.1 Structure	129
	A 5.4.2 Video Signal	130
	A 5.4.3 Exposure Time.....	130
	A 5.4.4 Encoder	130
	A 5.4.5 Measured Value Counter.....	130
	A 5.4.6 Time Stamp	130
	A 5.4.7 Measurement Data (Displacements and Intensities).....	131
	A 5.4.8 Trigger Time Difference	131
	A 5.4.9 Differences (thicknesses)	131
	A 5.4.10 Statistical values	131
	A 5.4.11 Peaksymmetrie	131
A 5.5	Measurement Data Format	132
	A 5.5.1 Data Format RS422 Interface	132
	A 5.5.1.1 Video Data.....	132
	A 5.5.1.2 Measurements	132
	A 5.5.2 Measurement Data Transmission to a Server via Ethernet.....	134
	A 5.5.2.1 General.....	134
	A 5.5.2.2 Measurement Frame	135
	A 5.5.2.3 Example	136
	A 5.5.2.4 Error Codes Ethernet Interface	136
	A 5.5.3 Ethernet Video Signal Transmission	136
A 5.6	Warning and Error Messages.....	137

A 6	EtherCAT Documentation	139
A 6.1	General	139
A 6.2	Switching between Ethernet and EtherCAT	139
A 6.3	Introduction	139
A 6.3.1	Structure of EtherCAT® Frames	139
A 6.3.2	EtherCAT® services	140
A 6.3.3	Addressing and FMMUs	140
A 6.3.4	Sync managers	141
A 6.3.5	EtherCAT state machine	141
A 6.3.6	CANopen over EtherCAT	141
A 6.3.7	Process data PDO mapping	142
A 6.3.8	Service data SDO service	142
A 6.4	CoE object directory	143
A 6.4.1	Communication-specific standard objects	143
A 6.4.1.1	Overview	143
A 6.4.1.2	Object 1001h: Device type	143
A 6.4.1.3	Object 1008h: Manufacturer's device name	143
A 6.4.1.4	Object 1009h: Hardware version	143
A 6.4.1.5	Object 100Ah: Software version	143
A 6.4.1.6	Object 1018h: Device identification	143
A 6.4.1.7	TxPDO Mapping	144
A 6.4.1.8	Object 1C00h: Type of synchronization manager	146
A 6.4.1.9	Object 1C12h: RxPDO Assign	146
A 6.4.1.10	Object 1C13h: TxPDO Assign	146
A 6.4.1.11	Object 1C33h: Synchronization manager input parameters	147
A 6.4.2	Manufacturer-specific objects	148
A 6.4.2.1	Overview	148
A 6.4.2.2	Object 2001h: User level	150
A 6.4.2.3	Object 2005h: Controller info (continued)	150
A 6.4.2.4	Object 2011h: Correction, channel 1	150
A 6.4.2.5	Object 2020h: Load, save, factory settings	151
A 6.4.2.6	Object 2021h: Preset	151
A 6.4.2.7	Object 2022h: Measurement settings	151
A 6.4.2.8	Object 203Fh: Sensor error	152
A 6.4.2.9	Object 2101h: Reset	152
A 6.4.2.10	Object 2105h: Factory settings	152
A 6.4.2.11	Object 2107h: Reset counter	152
A 6.4.2.12	Object 2133h: LED light source channel 1	152
A 6.4.2.13	Object 2141h: Request video signal	152
A 6.4.2.14	Object 2142h: Share video signal	152
A 6.4.2.15	Object 2150h: Sensor channel 1	153
A 6.4.2.16	Object 2152h: Sensor selection channel 1	153
A 6.4.2.17	Object 2156h: Multilayer options for channel 1	153
A 6.4.2.18	Object 2161h: Peak selection for channel 1	153
A 6.4.2.19	Object 2162h: Peak options for channel 1	154
A 6.4.2.20	Object 2183h: Spike correction for channel 1	154
A 6.4.2.21	Object 21B0h: Digital interfaces	154
A 6.4.2.22	Object 21B1h: Select interface	155
A 6.4.2.23	Object 21C0h: Ethernet	155
A 6.4.2.24	Object 21D0h: Analog output	155
A 6.4.2.25	Object 21F3h: Switching output 1	156
A 6.4.2.26	Object 2250h: Exposure mode for channel 1	156
A 6.4.2.27	Object 2251h: Measuring rate	157
A 6.4.2.28	Object 24A0h: Keylock	157
A 6.4.2.29	Object 24A2h: Multi-function button	157
A 6.4.2.30	Object 25A0h: Encoder	158
A 6.4.2.31	Object 2711h: Masking the evaluation range for channel 1	158
A 6.4.2.32	Object 2800h: Material information	159
A 6.4.2.33	Object 2802h: Edit material table	159
A 6.4.2.34	Object 2803h: Existing materials	159
A 6.4.2.35	Object 2804h: Select material for channel 1	160
A 6.4.2.36	Object 2A00h: Mastering	160
A 6.4.2.37	Object 2A10h: Statistics	160
A 6.4.2.38	Object 2C00h: Measured value calculation for channel 1	162
A 6.4.2.39	Object 2CBFh: Sys Signals	163
A 6.4.2.40	Object 2E00: User signals	163
A 6.5	Mappable objects – process data	164
A 6.6	Error codes for SDO services	165
A 6.7	Oversampling	166
A 6.8	Calculations	168
A 6.8.1	Setting a filter	168
A 6.8.2	Thickness calculation	168
A 6.8.3	Channel calculation	169
A 6.9	Operational modes	169
A 6.9.1	Free run	169
A 6.9.2	Distributed clocks SYNC0 synchronization	169
A 6.10	Video signal via SDO	169
A 6.11	STATUS LEDs in EtherCAT operation	170
A 6.12	EtherCAT configuration with the Beckhoff TwinCAT® Manager	170

1. Safety

System operation assumes knowledge of the operating instructions.

1.1 Symbols Used

The following symbols are used in these operating instructions:



Indicates a hazardous situation which, if not avoided, may result in minor or moderate injury.



Indicates a situation that may result in property damage if not avoided.



Indicates a user action.



Indicates a tip for users.



Indicates hardware or a software button/menu.

1.2 Warnings



Connect the power supply and the display/output device according to the safety regulations for electrical equipment.

> Risk of injury

> Damage to or destruction of the controller



The supply voltage must not exceed the specified limits.

> Damage to or destruction of the controller

Avoid shocks and impacts to the controller and the sensor.

> Damage to or destruction of the components

Never fold the fiber optics and do not bend them in tight radii.

> Damage to or destruction of the fiber optics; failure of measuring device

Protect the ends of the fiber optics against contamination (use protective caps).

> Incorrect measurement

> Failure of the measuring device

Protect the cables against damage.

> Failure of the measuring device

1.3 Notes on Product Marking

1.3.1 CE Marking

The following applies to the product:

- Directive 2014/30/EU ("EMC")
- Directive 2011/65/EU ("RoHS")

Products which carry the CE marking satisfy the requirements of the EU Directives cited and the relevant applicable harmonized European standards (EN). The product is designed for use in industrial and laboratory environments.

The EU Declaration of Conformity and the technical documentation are available to the responsible authorities according to the EU Directives.

1.3.2 UKCA Marking

The following applies to the product:

- SI 2016 No. 1091 (“EMC“)
- SI 2012 No. 3032 (“RoHS“)

Products which carry the UKCA marking satisfy the requirements of the directives cited and the relevant applicable harmonized standards. The product is designed or use in industrial and laboratory environments.

The UKCA Declaration of Conformity and the technical documentation are available to the responsible authorities according to the UKCA Directives.

1.4 Intended Use

- The confocalDT 2421/2422/2465/2466 is designed for use in industrial and residential applications. It is used for
 - measuring displacement, distance, profile, thickness and surface inspection
 - monitoring quality and checking dimensions
- The system must only be operated within the limits specified in the technical data, [see 2.6](#).
- The sensor must be used in such a way that no persons are endangered or machines and other material goods are damaged in the event of malfunction or total failure of the controller.
- Take additional precautions for safety and damage prevention in case of safety-related applications.

1.5 Proper Environment

- Protection class
 - Sensor: IP40 ... IP65, [see 2.6](#)
 - Controller: IP40

Optical inputs are excluded from protection class. Contamination leads to impairment or failure of the function.

- Temperature range
 - Operation:
 - Sensor: +5 ... +70 °C (+41 ... +158 °F)
 - Controller: +5 ... +50 °C (+41 ... +122 °F)
 - Storage: -20 ... +70 °C (-4 ... +158 °F)
- Humidity: 5 ... 95 % (non-condensing)
- Ambient pressure: atmospheric pressure
- EMC: According to EN 61000-6-3 / EN 61326-1 (Class B) and EN 61 000-6-2 / EN 61326-1.

2. Functional Principle, Technical Data

2.1 Short Description

The confocalDT 2421/2422/2465/2466 measuring system includes:

- one or two sensors IFS24xx inclusive an optical fiber (optic cable),
- one controller IFC2421, IFC2422, IFC2465 or IFC2466,

The controller comes with one (IFC2421, IFC2465) or two (IFC2422, IFC2466) integrated white light LED's as an internal light source.

The sensor is completely passive as it contains no heat sources or moving parts. This prevents any heat-related expansion, and ensures high precision of the measuring system.

The controller uses a spectrometer to convert any light signals that it receives from the sensor. It then calculates distance values using the integrated signal processor (CPU) and transfers the data via its interfaces or the analog output.

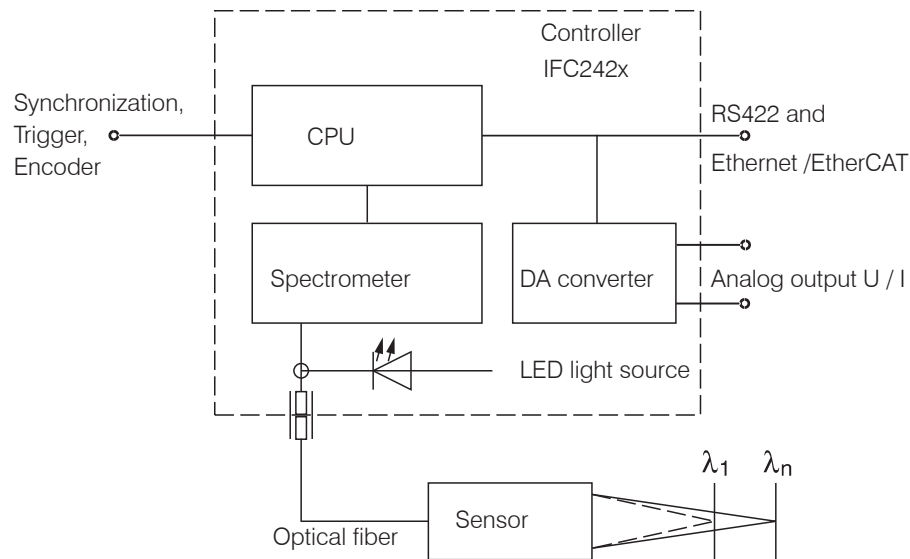

Fig. 1 Block diagram confocalDT 2421, 2465

2.2 Measuring Principle

The sensor projects polychromatic light (white light) to the target surface. The sensor lenses are designed to use controlled chromatic aberration to focus each light wavelength at a specific distance. In reverse, the sensor will then receive the light that is reflected from the target surface and transfer it to the controller. This is followed by the spectral analysis, and then the data stored in the controller are used to calculate the distances.

- Sensor and controller are one unit, as the sensor's linearization table is stored in the controller.

This unique measuring system allows for highly precise measurement of applications. It is possible to measure both diffuse and reflecting surfaces. For transparent layered materials, thickness measurements can be conducted in addition to distance measurements. Shadowing is avoided because sender and receiver are aligned along one axis.

The excellent resolution and the small beam spot diameter make it possible to measure surface structures. However, measurement deviations may occur if the structure is of a similar size to the beam spot diameter or if the maximum tilt angle is exceeded (for example, with groove edges).

2.3 Glossary

- SMR Start of measuring range. Minimum distance between sensor surface and target
- MMR Mid of measuring range
- EMR End of measuring range (start of measuring range + measuring range)
Maximum distance between sensor face and target
- MR Measuring range

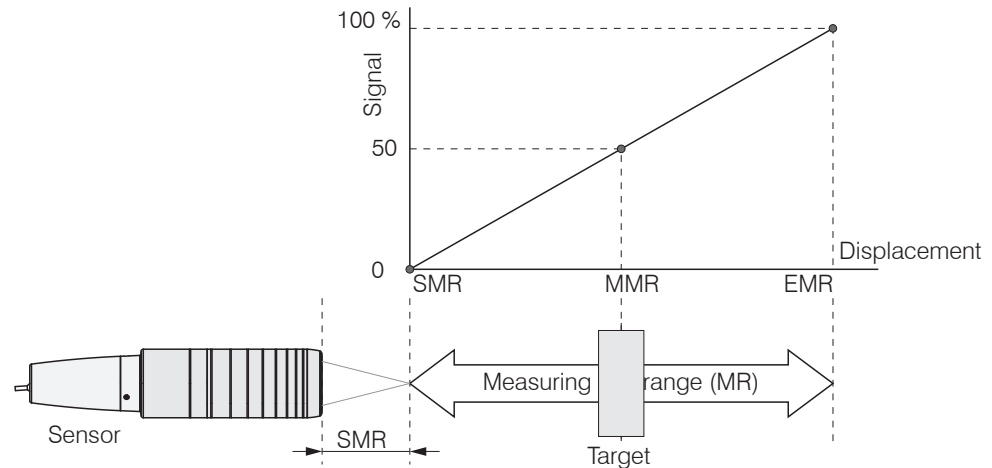

Fig. 2 Measuring range and output signal at the controller

2.4 Operating Modes

The sensor measuring ranges extend from a few tenths of micrometers to several millimeters. The controllers measure up to 6 peaks in the video signal.

Dual-channel systems (IFC2422 / IFC2466) evaluate the measurement values of both channels.

For a quick start, we recommend to use presets defined for different target surfaces, [see 5.2.2](#).

2.5 Sensors

The controller can be operated with up to 20 different sensors per channel. The required calibration tables are stored within the controller.

The sensor is a passive element in the measuring system: it contains neither moving nor heat-generating parts which might affect measuring accuracy due to thermal expansion in the sensor.

- **i** Protect the ends of the sensor cables (optical fibers) and the sensor lens from dirt and contamination.

2.6 Technical Data

Model	IFS	2402-0,5	2402-1,5	2402-4	2402-10	2402/90-1,5	2402/90-4	2402/90-10	
Measuring range		0.5 mm	1.5 mm	3.5 mm	6.5 mm	1.5 mm	2.5 mm	6.5 mm	
Start of measuring range	approx.	1.7 mm	0.9 mm	1.9 mm	2.5 mm	2.5 mm ¹	2.5 mm ¹	3.5 mm ¹	
Resolution	static ²	16 nm	60 nm	100 nm	200 nm	60 nm	100 nm	200 nm	
	dynamic ³	48 nm	192 nm	480 nm	960 nm	192 nm	480 nm	960 nm	
Linearity ⁴	Displacement and distance	< ±0.2 μm	< ±1.2 μm	< ±3 μm	< ±13 μm	< ±1.2 μm	< ±3 μm	< ±13 μm	
	Thickness	< ±0.6 μm	< ±2.4 μm	< ±6 μm	< ±16 μm	< ±2.4 μm	< ±6 μm	< ±16 μm	
Light spot diameter		10 μm	20 μm	20 μm	100 μm	20 μm	20 μm	100 μm	
Max. measuring angle ⁵		±18°	±5°	±3°	±1.5°	±5°	±3°	±1.5°	
Numerical aperture (NA)		0.40	0.20	0.10	0.10	0.20	0.10	0.10	
Connection		integrated optical fiber 2 m with E2000/APC connector; extension up to 50 m; bending radius: static 30 mm, dynamic 40 mm							
Installation		Clamping, mounting adapter (see accessories)							
Temperature range	Storage	-20... +70 °C (-4 ... +158 °F)							
	Operation	+5 ... +70 °C (+41 ... +158 °F)							
Shock (DIN-EN 60068-2-27)		15 g / 6 ms in XY axis, 1000 shocks each							
Vibration (DIN-EN 60068-2-6)		2 g / 20 Hz ... 500 Hz in XY axis, 10 cycles each							
Protection class (DIN-EN 60529)		IP64 (front operated)				IP40			
Material		Stainless steel housing, glass lenses							
Weight		approx. 186 g (incl. optical fiber)							

Model	IFS	2403-0,4	2403-1,5	2403-4	2403-10	2403/90-1,5	2403/90-4	2403/90-10	
Measuring range		0.4 mm	1.5 mm	4 mm	10 mm	1.5 mm	4 mm	10 mm	
Start of measuring range	approx.	2.5 mm	8.0 mm	14.7 mm	11 mm	4.9 mm ¹	12 mm ¹	8.6 mm ¹	
Resolution	static ²	16 nm	60 nm	100 nm	250 nm	60 nm	100 nm	250 nm	
	dynamic ³	47 nm	186 nm	460 nm	1250 nm	186 nm	460 nm	1250 nm	
Linearity ⁴	Displacement and distance	< ±0.3 μm	< ±1.2 μm	< ±3 μm	< ±8 μm	< ±1.2 μm	< ±3 μm	< ±8 μm	
	Thickness	< ±0.6 μm	< ±2.4 μm	< ±6 μm	< ±16 μm	< ±2.4 μm	< ±6 μm	< ±16 μm	
Light spot diameter		9 μm	15 μm	28 μm	56 μm	15 μm	28 μm	56 μm	
Max. measuring angle ⁵		±20°	±16°	±6°	±6°	±16°	±6°	±6°	
Numerical aperture (NA)		0.5	0.3	0.15	0.15	0.3	0.15	0.15	
Min. target thickness ⁶		0.06 mm	0.23 mm	0.6 mm	1.5 mm	0.23 mm	0.6 mm	1.5 mm	
Connection		integrated optical fiber 2 m with E2000/APC connector; extension up to 50 m; bending radius: static 30 mm, dynamic 40 mm							
Installation		Clamping, mounting adapter (see accessories)							
Temperature range	Storage	-20 ... +70 °C (-4 ... +158 °F)							
	Operation	+5 ... +70 °C (+41 ... +158 °F)							
Shock (DIN-EN 60068-2-27)		15 g / 6 ms in XY in XY axis, 1000 shocks each							
Vibration (DIN-EN 60068-2-6)		2 g / 20 Hz ... 500 Hz in XY axis, 10 cycles each							
Protection class (DIN-EN 60529)		IP64 (front operated)				IP40			
Material		Stainless steel housing, glass lenses							
Weight		approx. 200 g (incl. optical fiber)							

1) Start of measuring range measured from sensor axis.

2) Average from 512 values at 1 kHz, near to the midrange onto optical flat

3) RMS noise relates to mid of measuring range (1 kHz)

4) All data at constant ambient temperature (25 ±1 °C) against optical flat; specifications can change when measuring different materials.

5) Maximum measuring angle of the sensor that produces a usable signal on reflecting surfaces. The accuracy decreases when approaching the limit values.

6) Glass with refractive index n = 1.5 in midrange

Model	IFS	2404-2	2404/90-2	2404-2(001)	2404/90-2(001)
Measuring range		2 mm	2 mm	2 mm	2 mm
Start of measuring range	approx.	14 mm	9.6 mm ¹	14 mm	9.6 mm ¹
Resolution	static ²	40 nm	40 nm	40 nm	40 nm
	dynamic ³	125 nm	125 nm	125 nm	125 nm
Linearity ⁴	Displacement and distance	< ±1 μm	< ±1 μm	< ±1 μm	< ±1 μm
	Thickness	< ±2 μm	< ±2 μm	< ±2 μm	< ±2 μm
Light spot diameter		10 μm	10 μm	10 μm	10 μm
Max. measuring angle ⁵		±12°	±12°	±12°	±12°
Numerical aperture (NA)		0.25	0.25	0.25	0.25
Min. target thickness ⁶		0.1 mm	0.1 mm	0.1 mm	0.1 mm
Connection		pluggable optical fiber via FC socket, type C2404-x; standard length 2 m; extension up to 50 m; bending radius: static 30 mm, dynamic 40 mm		pluggable optical fiber via FC socket, standard length 3 m; extension up to 50 m; bending radius: static 30 mm, dynamic 40 mm	
Installation		Clamping, mounting adapter (see accessories)			
Temperature range	Storage	-20 ... +70 °C (-4 ... +158 °F)			
	Operation	+5 ... +70 °C (+41 ... +158 °F)			
Shock (DIN-EN 60068-2-27)		15 g / 6 ms in XY axis, 1000 shocks each			
Vibration (DIN-EN 60068-2-6)		2 g / 20 Hz ... 500 Hz in XY axis, 10 cycles each			
Protection class (DIN-EN 60529)		IP65 (front operated)			
Material		Stainless steel housing, glass lenses			
Weight		approx. 20 g	approx. 30 g	approx. 40 g	approx. 50 g

Model IFS		2405-0,3	2405-1	2405-3	2405-6	2405/90-6	2405-10	2405-28	2405-28/ VAC(001)	2405-30
Measuring range		0.3 mm	1 mm	3 mm	6 mm	6 mm	10 mm	28 mm		30 mm
Start of measuring range	approx.	6 mm	10 mm	20 mm	63 mm	41 mm ¹	50 mm	220 mm		100 mm
Resolution	static ²	4 nm	8 nm	15 nm	34 nm	34 nm	36 nm	130 nm		93 nm
	dynamic ³	18 nm	38 nm	80 nm	190 nm	190 nm	204 nm	747 nm		530 nm
Linearity ⁴	Displacement and distance	< ±0.1 μm	< ±0.25 μm	< ±0.75 μm	< ±1.5 μm	< ±1.5 μm	< ±2.5 μm	< ±7.0 μm		< ±6 μm
	Thickness	< ±0.2 μm	< ±0.5 μm	< ±1.5 μm	< ±3 μm	< ±3 μm	< ±5 μm	< ±14 μm		< ±12 μm
Light spot diameter		6 μm	8 μm	9 μm	31 μm	31 μm	16 μm	60 μm		50 μm
Max. measuring angle ⁵		±34°	±30°	±24°	±10°	±10°	±17°	±5°		±9°
Numerical aperture (NA)		0.6	0.55	0.45	0.22	0.22	0.3	0.1		0.2
Min. target thickness ⁶		0.015 mm	0.05 mm	0.15 mm	0.3 mm	0.3 mm	0.5 mm	2.2 mm		1.5 mm
Connection		pluggable optical fiber via FC socket; standard length 3 m; extension up to 50 m; bending radius: static 30 mm, dynamic 40 mm								
Installation		Clamping, mounting adapter (see accessories)								
Temperature range	Storage	-20 ... +70 °C (-4 ... +158 °F)								
	Operation	+5 ... +70 °C (+41 ... +158 °F)								
Shock (DIN-EN 60068-2-27)		15 g / 6 ms in XY axis, 1000 shocks each								
Vibration (DIN-EN 60068-2-6)		2 g / 20 Hz ... 500 Hz in XY axis, 10 cycles each								
Protection class (DIN-EN 60529)		IP64 (front operated)								
Material		Aluminum housing, glass lenses							Burnished stainless steel housing	Aluminum housing, glass lenses
Weight	approx.	140 g	125 g	225 g	260 g	315 g	500 g	750 g		730 g

1) Start of measuring range measured from sensor axis.

2) Average from 512 values at 1 kHz, near to the midrange onto optical flat

3) RMS noise relates to mid of measuring range (1 kHz)

4) All data at constant ambient temperature (25 ±1 °C) against optical flat; specifications can change when measuring different objects.

5) Maximum measuring angle of the sensor that produces a usable signal on reflecting surfaces. The accuracy decreases when approaching the limit values.

6) Glass with refractive index $n = 1.5$ throughout the entire measuring range. In the mid of the measuring range, also thinner layers can be measured.

Model	IFS	2406-2,5/VAC(003)	2406/90-2,5/VAC(001)	2406-3	2406-10	2406-10/ VAC(001)	2406-3/ VAC(001)	
Measuring range		2.5 mm		3 mm	10 mm		3 mm	
Start of measuring range	approx.	17.2 mm	12.6 mm ¹	75 mm	27 mm		75 mm	
Resolution	static ²	18 nm		32 nm	38 nm		50 nm	
	dynamic ³	97 nm		168 nm	207 nm		168 nm	
Linearity ⁴	Displacement and distance	< ± 0.75 μm		< ± 1.5 μm	< ± 2 μm		< ± 1.5 μm	
	Thickness	< ± 1.5 μm		< ± 3.0 μm	< ± 4 μm		< ± 3 μm	
Light spot diameter		10 μm		35 μm	15 μm		35 μm	
Max. measuring angle ⁵		±16°		±6.5°	±13.5°		±6,5°	
Numerical aperture		0.3		0.14	0.25		0.14	
Min. target thickness ⁶		0.125 mm		0.15 mm	0.5 mm		0.15 mm	
Connection (pluggable optical fiber via FC socket; length 3 m, extension up to 50 m)		type C240x-x (01); bending radius: static 30 mm, dynamic 40 mm					type C240x-x/ VAC(01); bending radius: static 30 mm, dynamic 40 mm	
Installation		Clamping, mounting adapter (see accessories)						
Temperature range	Storage	-20 ... +70 °C (-4 ... +158 °F)						
	Operation	+5 ... +70 °C (+41 ... +158 °F)						
Shock (DIN-EN 60068-2-27)		15 g / 6 ms in XY axis, 1000 shocks each						
Vibration (DIN-EN 60068-2-6)		2 g / 20 Hz ... 500 Hz in XY axis, 10 cycles each						
Protection class (DIN-EN 60529)		IP40 (vacuum compatible)		IP65 (front operated)	IP40 (vacuum compatible)	IP40 (vacuum compatible)		
Weight		approx. 105 g	approx. 130 g	approx. 99 g	approx. 128 g		approx. 250 g	

Model	IFS	2407-0,1	2407-0,1(001)	2407-0,8	2407/90-0,3	2407-3
Measuring range		0.1 mm		0.8 mm	0.3 mm	3 mm
Start of measuring range	approx.	1 mm		5.9 mm	5.3 mm	28 mm
Resolution	static ²	3 nm		24 nm	10 nm	20 nm
	dynamic ³	6 nm		75 nm	20 nm	58 nm
Linearity ⁴	Displacement and distance	< ±0.05 μm		< ±0.2 μm	< ±0.15 μm	< ±0.5 μm
	Thickness	< ±0.1 μm		< ±0.4 μm	< ±0.3 μm	< ±1 μm
Light spot diameter		3 μm	4 μm	6 μm	6 μm	9 μm
Max. measuring angle ⁵		±48°	±48°	±30°	±27°	±30°
Numerical aperture		0.8	0.7	0.5	0.5	0.53
Min. target thickness ⁶		0.005 mm		0.04 mm	0.015 mm	0.15 mm
Connection (pluggable optical fiber via FC socket; length 3 m, extension up to 50 m)		FC socket; bending radius: static 30 mm, dynamic 40 mm			DIN socket; type C2407-x; bending radius: static 30 mm, dynamic 40 mm	FC socket; bending radius: static 30 mm, dynamic 40 mm
Installation		Clamping, mounting adapter (see accessories)			Mounting holes (2x M2)	Clamping, mounting adapter (see accessories)
Temperature range	Storage	-20 ... +70 °C (-4 ... +158 °F)				
	Operation	+5 ... +70 °C (+41 ... +158 °F)				
Shock (DIN-EN 60068-2-27)		15 g / 6 ms in XY axis, 1000 shocks each				
Vibration (DIN-EN 60068-2-6)		2 g / 20 Hz ... 500 Hz axis, 10 cycles each				
Protection class (DIN-EN 60529)		IP65 (front operated)				
Material		Stainless steel housing, glass lenses				Aluminum, glass lenses
Weight ⁷		approx. 36 g		approx. 40 g	approx. 30 g	approx. 550 g
Features		high numerical aperture	Light-intensive sensor	-	-	-

1) Start of measuring range measured from sensor axis.

2) Average from 512 values at 1 kHz, near to the midrange onto optical flat

3) RMS noise relates to mid of measuring range (1 kHz)

4) All data at constant ambient temperature (25 ± 1 °C) against optical flat; specifications can change when measuring different materials.

5) Maximum measuring angle of the sensor that produces a usable signal on reflecting surfaces. The accuracy decreases when approaching the limit values.

6) Glass with refractive index n = 1.5 in midrange

7) Sensor weight without optical fibre

Model	IFC	2421	2421MP	2422	2422MP	2465	2465MP	2466	2466MP
Resolution	Ethernet/EtherCAT	1 nm							
	RS422	18 bit							
	Analog	16 bits (teachable)							
Measuring rate		continuously adjustable from 100 Hz to 10 kHz ¹				continuously adjustable from 100 Hz to 30 kHz			
Linearity		typ. < ± 0.025 % FSO (depends on sensor)							
Multi-layer measurement		1 layer	5 layers	1 layer	5 layers	1 layer	5 layers	1 layer	5 layers
Light source		internal white LED							
No. of characteristic curves		up to 20 characteristic curves for different sensors per channel, selection via table in the menu							
Permissible ambient light ²		30,000 lx							
Synchronization		yes							
Supply voltage		24 VDC ± 15 %							
Power consumption		approx. 10 W							
Signal input		sync-in / trig-in; 2x encoders (A+, A-, B+, B-, index); 3x encoders (A+, A-, B+, B-)							
Digital interface		Ethernet / EtherCAT / RS422 / PROFINET ³ / EtherNet/IP ³							
Analog output		Current: 4 ... 20 mA; voltage: 0 ... 10 V (16 bit D/A converter)							
Switching output		Error1-Out, Error2-Out							
Digital output		sync-out							
Connection	Optical	pluggable optical fiber via E2000 socket, length 2 m ... 50 m, min. bending radius 30 mm							
	Electrical	3-pin supply terminal strip; encoder connection (15-pin, HD-sub socket, max. cable length 3 m, 30 m with external encoder supply); RS422 connection socket (9-pin, Sub-D, max. cable length 30 m); 3-pin output terminal strip (max. cable length 30 m); 11-pin I/O terminal strip (max. cable length 30 m); RJ45 socket for Ethernet (out) / EtherCAT (in/out) (max. cable length 100 m)							
Mounting		free-standing, DIN rail mounting							
Temperature range	Storage	-20 ... +70 °C (-4 ... +158 °F)							
	Operation	+5 ... +50 °C (+41 ... +122 °F)							
Shock (DIN EN 60068-2-27)		15 g / 6 ms in XYZ axis, 1000 shocks each							
Vibration (DIN EN 60068-2-6)		2 g / 20 ... 500 Hz in XYZ axis, 10 cycles each							
Protection class (DIN EN 60529)		IP40							
Material		Aluminum							
Weight		approx. 1.8 kg		approx. 2.25 kg		approx. 1.8 kg		approx. 2.25 kg	
Compatibility		compatible with all confocalDT sensors							
No. of measurement channels ⁴		1		2		1		2	
Control and indicator elements		multifunction button (two adjustable functions and reset to factory setting after 10 s); 5x LEDs for intensity, range, status and supply voltage							

FSO = Full Scale Output

1) Full measuring range up to 8 kHz. Depending on the sensor up to 80 % FSO between 9 and 10 kHz

2) Illuminant: light bulb

3) Connection via interface module (see accessories)

4) No loss of intensity and linearity due to two synchronous measurement channels

3. Delivery

3.1 Unpacking, Included in Delivery

- 1 Controller IFC2421/2422/2465/2466
- 1 Sensor with sensor cable (optical fiber)
- 1 RJ patch cable Cat5 2 m
- 1 Test certificate

- ➡ Carefully remove the components of the measuring system from the packaging and ensure that the goods are forwarded in such a way that no damage can occur.
- ➡ Check the delivery for completeness and shipping damage immediately after unpacking.
- ➡ If there is damage or parts are missing, immediately contact the manufacturer or supplier.

3.2 Storage

- Temperature range storage: -20 ... +70 °C (-4 ... +158 °F)
- Humidity: 5 ... 95 % (non-condensing)

4. Installation

4.1 Controller IFC2421/2422/2465/2466

Place the controller IFC2421/2422/2465/2466 on a level surface, or install it at a location of your choice (e.g. in a switch cabinet) using a DIN EN 60715 mounting rail (DIN rail TS35).

When using a DIN rail, an electrical connection (potential equalization) is established between the controller case and the rail.

➡ To remove, push the controller upwards, and pull it forwards.

i When attaching the controller, ensure that no connections, operating or display elements are covered.

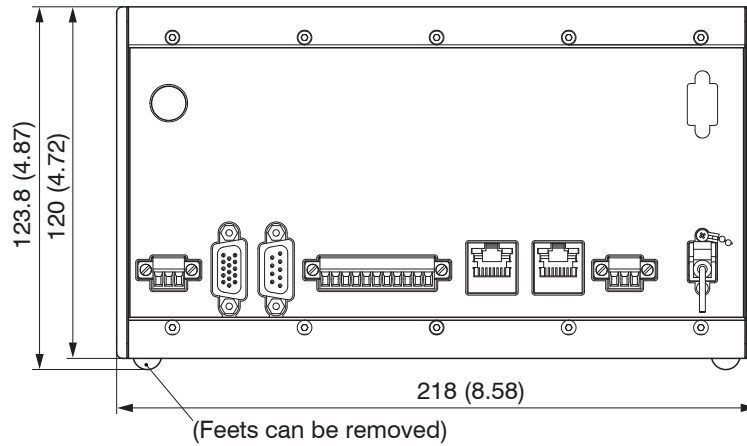

Fig. 3 Dimensional drawing controller IFC2421/2465, dimensions in mm

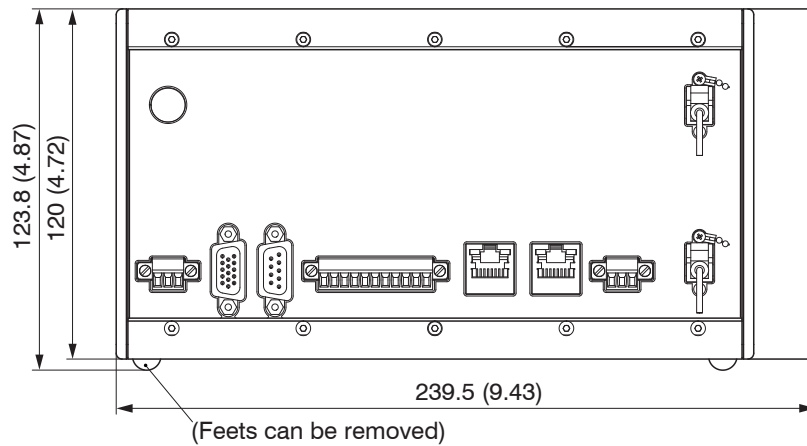

Fig. 4 Dimensional drawing controller IFC2422/2466, dimensions in mm

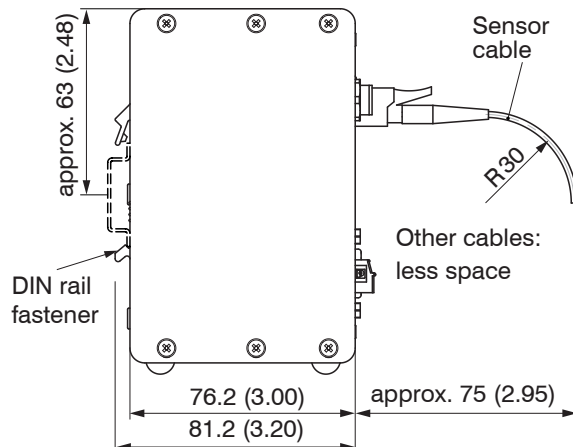

Fig. 5 Dimensional drawing side view, controllers IFC2421/2422/2465/2466, dimensions in mm

4.2 Controller Operating Elements

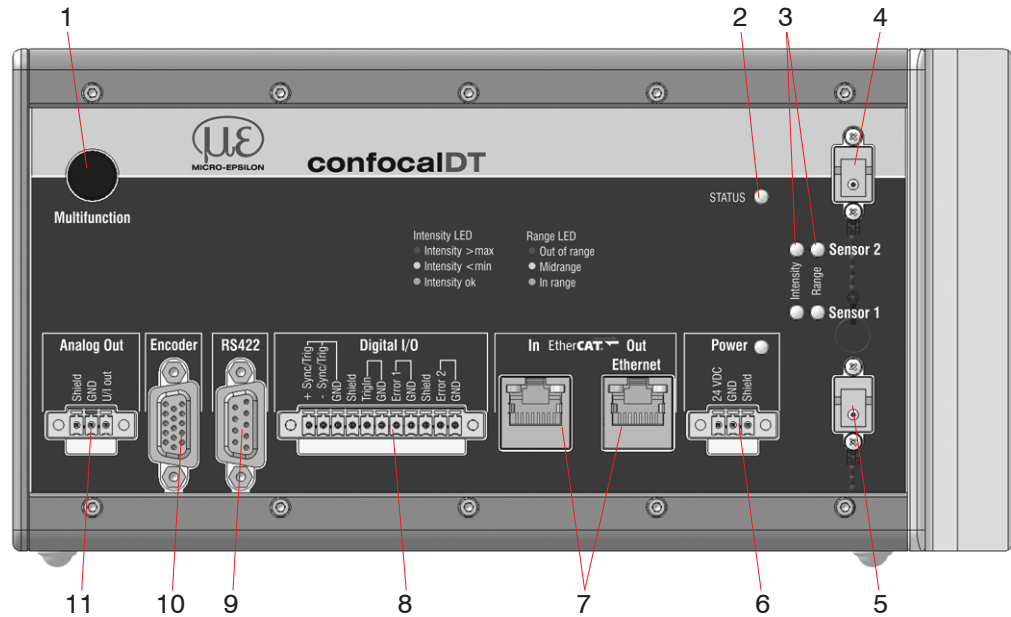

Fig. 6 Front view Controller IFC2422 (IFC2421, IFC2465, IFC2466)

1	Button Multifunction (dark reference, light source) ¹	7	Ethernet / EtherCAT
2	Status LED	8	Digital I/O
3	LEDs Intensity, Range	9	RS422 connector
4	Sensor connection channel 2 (optical fiber) ²	10	Encoder connector
5	Sensor connection channel 1 (optical fiber)	11	Analog output (U / I)
6	Power supply connection, LED Power On		

- 1) Resetting to factory settings: press the Multifunction button for more than 10 sec.
- 2) On controller IFC2422 and IFC2466 only.

4.3 Controller LEDs

Power on	Green	Active operating voltage
Status	Off	No errors
	Flashing red	Processing error
	If EtherCAT is active, meaning of the LED is conform with the EtherCAT guidelines.	
Intensity channel 1/2 	Flashing red	Dark reference in progress
	Red	Signal in saturation
	Yellow	Signal too low
	Green	Signal OK
Range channel 1/2 	Flashing red	Dark reference in progress
	Red	No target object, or target object outside the measuring range
	Yellow	Target object near the midrange
	Green	Target object within the measuring range

Fig. 7 Description of the controller LEDs

The LED's Intensity and Range flashes with their current color during a synchronization error.

4.4 Electrical Connections Controller

4.4.1 Connection Possibilities

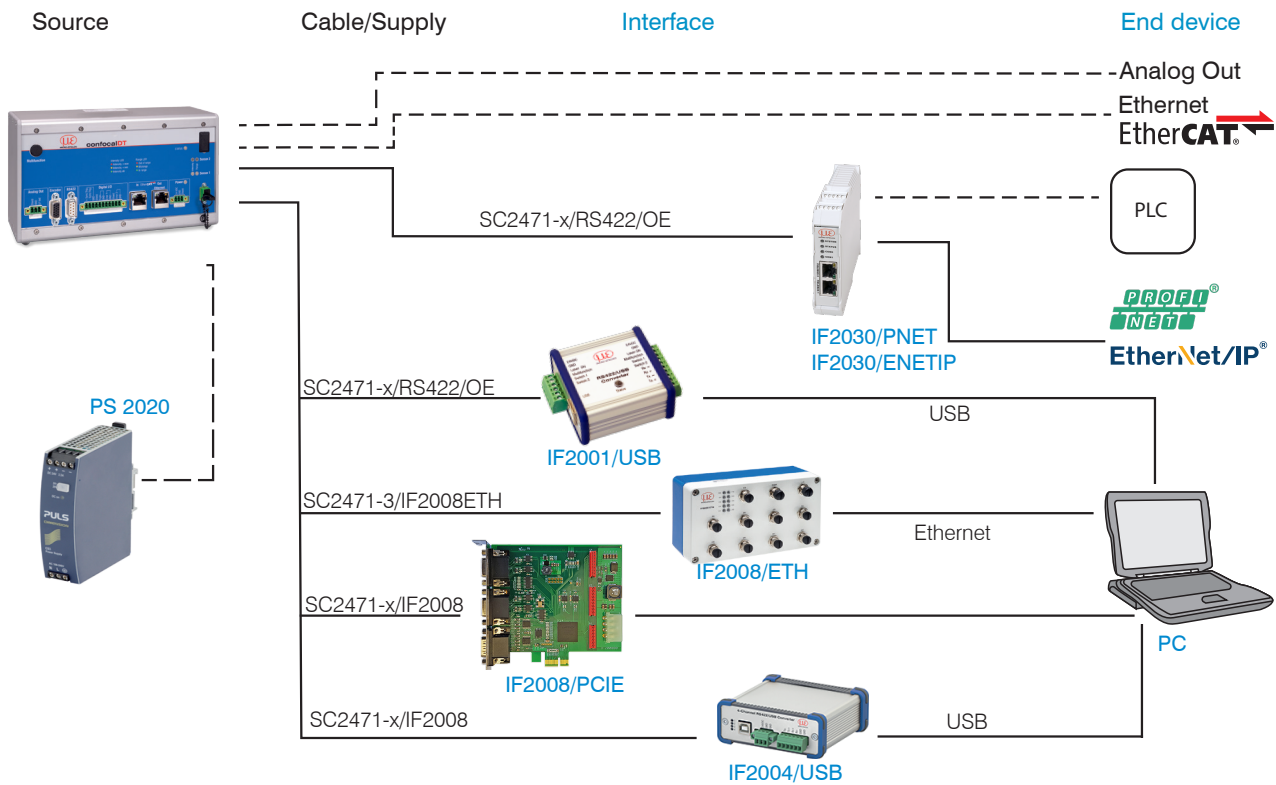

Fig. 8 Connection examples for confocalDT 2421/2422/2465/2466

The different periphery devices, see Fig. 7, can be connected by the illustrated connection cables.

Peripheral	Sensor channels	Power supply converter/modules	Interface
IF2001/USB, RS422-USB converter	1	optional available power supply PS2020	RS422
IF2030/PNET, IF2030/ENETIP	2		
IF2008/ETH	8		
IF2004/USB	4		
IF2008/PCIE, PCI interface card	4		

4.4.2 Handling of Pluggable Screw Terminals

The controller IFC2421/2422/2465/2466 has three pluggable screw terminals for supply, digital I/O and analog out, which are included as accessories.

- Remove approx. 7 mm of the connecting wire isolation (0.14 ... 1.5 mm²).
- Connect the connecting wires.
- i Use two captive screws to fix the screw terminals.

4.4.3 Grounding, Shielding

All inputs/outputs are electrically connected to the supply voltage ground (GND). Merely the Ethernet/EtherCAT ports are electrically isolated.

The the ground connections (GND, GND422, GND_ENC) of each group are interconnected via chokes.

The Shield connections of each connection group are only connected with the controller housing and are used for cable screen connections with individual connections (power, analog output, switching outputs, synchronization and trigger input).

Only use screened cables shorter than 30 m and connect the cable screen to the Shield or the connector housing.

4.4.4 Supply Voltage (Power)

- 3-pin pluggable screw terminal (24 VDC, GND, Shield),
- 24 VDC \pm 15 %, $I_{max} < 1A$
- not electrically isolated, GND is electrically connected to the GND wiring for switching outputs, synchronization and encoder input.

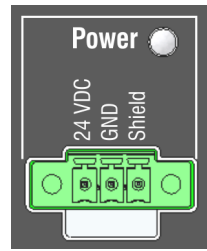

Fig. 9 Supply connection and LED on the controller IFC2421/2422/2465/2466

- ➡ Use a shielded cable of less than 30 m.

When the supply voltage has been connected, the `Power On` LED lights up.

- Use the supply voltage for measurement instruments only and not for drive units or similar sources of pulse interference at the same time. MICRO-EPSILON recommends using an optional available power supply unit PS2020 for the sensor.

4.4.5 RS422

- Differential signals in accordance with EIA-422, electrically isolated from the supply voltage.
- Receiver Rx with a 120 ohm internal terminating resistor.

- ➡ On the evaluation unit (receiver), terminate the transmitter input (Tx) with 90 ...120 Ohm.
- ➡ Use a shielded twisted cable of less than 30 m.
- ➡ Connect the earth connections.

- The pin assignment for the 9-pin D-sub connector is not standardized.

Pin	Name	Signal	
3	RX -	Receiver -	
2	RX +	Receiver +	
5	GND422	RS422 ground	
9	TX +	Transmitter +	
1	TX -	Transmitter -	
Cover	Shield	Cable shield	

Fig. 10 Pin assignment for the 9-pin D-sub connector (RS422)

4.4.6 Ethernet, EtherCAT

Potential isolated RJ 45 standard connector for connecting the controller IFC2421/2422/2465/2466

- to an Ethernet network (PC) or
- the EtherCAT bus system (IN-Port).

➡ Use a shielded Ethernet cable (Cat5E, patch cable, 2 m, included in the delivery, overall cable length less than 100 m to connect controller and network.

Both LEDs on the plug-in connector light up to indicate that the connection was successful and is active.

The measuring device can be configured through the web interface or using ASCII commands (e. g. Telnet), see A 5, or with EtherCAT objects.

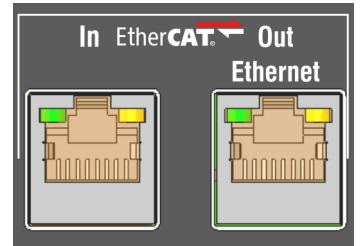

Fig. 11 Connectors RJ45 for Ethernet, EtherCAT

4.4.7 Analog Output

The two alternative analog outputs (voltage or current) are connected to the 3-pin screw terminal and are electrically connected to the supply voltage.

Voltage: Pin U/I_{out} and Pin GND,

R_i approx. 50 Ohm, R_L > 10 MOhm

Slew rate (no C_L, R_L ≥ 1 kOhm) typ. 0.5 V/μs

Slew rate (with C_L = 10 nF, R_L ≥ 1 kOhm) typ. 0.4 V/μs

Current: Pin U/I_{out} and Pin GND

R_L ≤ 500 Ohm

Slew rate (no C_L, R_L = 500 Ohm) typ. 1.6 mA/μs

Slew rate (with C_L = 10 nF, R_L = 500 Ohm) typ. 0.6 mA/μs

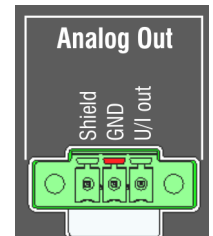

Fig. 12 Analog outputs on the controller

➡ Use a shielded cable of less than 30 m.

Pin 3 (Shield) is connected to the cover.

Alternatively, the following values may be defined for the output range:

Voltage: 0 ... 5 V; 0 ... 10 V;

Current: 4 ... 20 mA.

Only one reading can be produced as voltage or current.

- **i** The socket is mechanically coded (red plug-in) in order to avoid any confusion with the power supply.
- **i** To comply with IEC 61326-1:2020/CISPR 16-2-3, a split ferrite with an impedance of at least 140 ohms at 100 MHz with 2 turns must be attached to the analog output cable. MICRO-EPSILON recommends the split ferrite from Würth, article number 74271622.

4.4.8 Switching Outputs (Digital I/O)

Both switching outputs **Error 1/2** on the 11-pin pluggable screw terminal are electrically connected to the supply voltage.

The switching behavior (NPN, PNP, Push-Pull) is programmable, $I_{max} = 100 \text{ mA}$.

The maximum auxiliary voltage for a switching output with NPN switching behavior is 30 V.

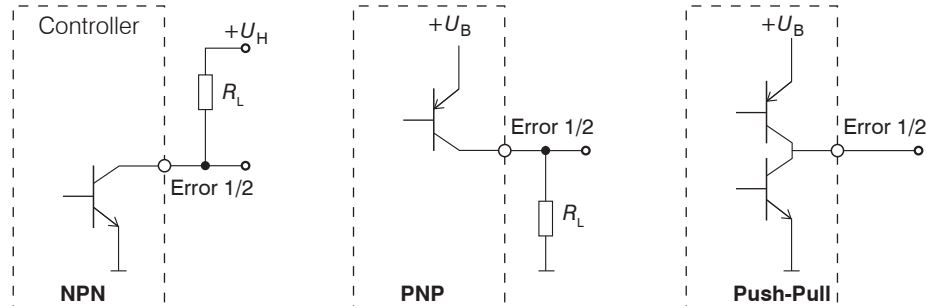

Fig. 13 Output behavior and wiring of the switching outputs **Error 1/2**

Switching output 1: pin **Error 1** and **GND**

Switching output 2: pin **Error 2** and **GND**

Cable shield: Shield is connected to the cover. Connect the cable shield.

All **GND** pins are interconnected, and they are connected to the power supply ground.

➡ Use a shielded cable of less than 30 m.

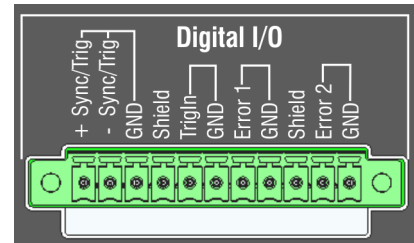

Fig. 14 Digital I/O on the controller

Output level (no load resistance), with a supply voltage of 24 VDC	Low < 1 V; High > 23 V
Saturation voltage at $I_{max} = 100 \text{ mA}$	Low < 2.5 V (Output - GND)
	High < 2.5 V (Output - $+ U_B$)

The saturation voltage is measured between output and **GND**, with output = Low, or between output and $+ U_B$, with output = High.

Description	Output active (error)	Output passive (no error)
NPN (Low side)	GND	$+ U_B$
PNP (High side)	$+ U_B$	GND
Push-Pull	$+ U_B$	GND
Push-Pull, negated	GND	$+ U_B$

Fig. 15 Switching behavior of the error outputs

NOTICE

The load resistance R_L can be dimensioned according to the limit values ($I_{max} = 100 \text{ mA}$, $U_{Hmax} = 30 \text{ V}$) and requirements. Do not connect inductive loads, e.g. a relay without parallel protection diodes.

4.4.9 Synchronization (Inputs/Outputs)

For the pin assignment of the 11-pin pluggable screw terminal, see Fig. 14

- +Sync/Trig and -Sync/Trig pins: symmetrical synchronization output/input or trigger input, function and (I/O) direction are programmable
- The terminating resistor R_T (120 Ohm) can be switched on and off via software, see 6.1.1.

All GND pins are interconnected, and they are connected to the power supply ground.

Signal	Level	
Sync/Trig	RS422 (EIA422)	
The function and I/O are programmable		

Fig. 16 Signal level synchronization, triggering

- ➡ Activate the terminating resistor 120 Ohm in the last controller (slave n) in the chain.

Star synchronization

- ➡ Connect the pins +Sync/Trig and -Sync/Trig of controller 1 (master) in star configuration with the pins +Sync/Trig and -Sync/Trig of controller 2 (slave) to controller n, in order to synchronize two or more controllers, see Fig. 17.
- Partial cable length less than 30 m with star synchronization.

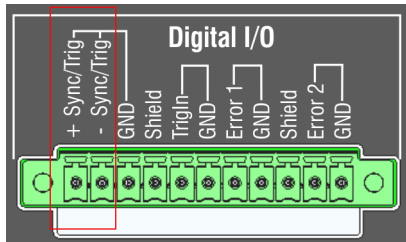
Cascaded synchronization

- ➡ Connect the pins +Sync/Trig and -Sync/Trig of controller 1 (master) with the pins +Sync/Trig and -Sync/Trig of controller 2 (slave 1). Connect the pins of downstream controllers in order to synchronize two or more controllers, see Fig. 17.
- Total cable length less than 30 m with cascaded synchronization.

- ➡ Use a shielded twisted cable.
- ➡ Connect the cable shield to Shield.
- ➡ Set Controller 1 to Master and the other controllers to Slave, see 6.1.1.

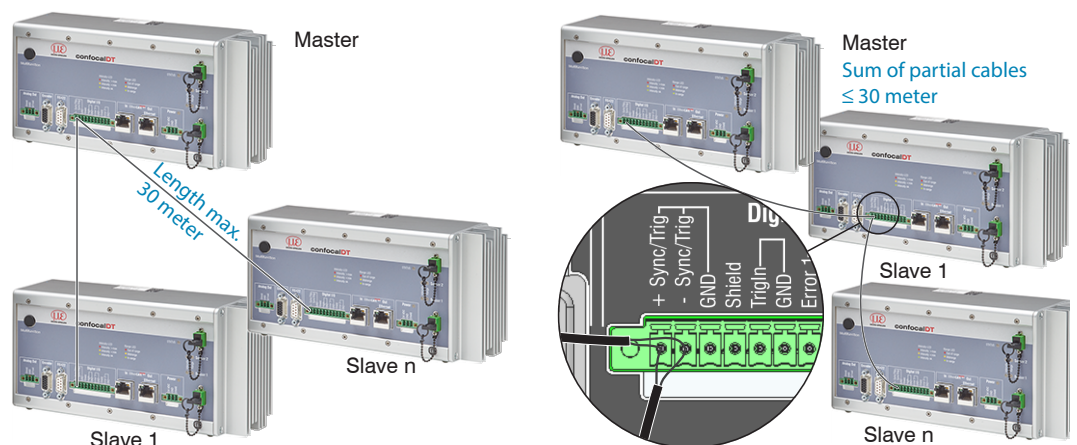

Fig. 17 Synchronization of more controllers, star synchronization (left), cascaded (right)

- ➡ Interconnected all GND, if the controllers are not supplied from a common power supply.
- If the controller are operated via the EtherCAT interface, then a synchronization even without the sync cable can be realized.

4.4.10 Triggering

The pluggable 11-pin screw terminal with Digital I/O has two trigger inputs.

Sync/Trig input

The Sync/Trig port can also be used as symmetrical trigger input for one or more controllers.

Program the Sync/Trig controller ports as trigger input.

The trigger source (master) must provide a symmetrical output signal according to the RS422 standard.

For asymmetrical trigger sources, we recommend the SU4 level converter (3 channels TTL/HTL to RS422) between trigger signal source and controller.

Encoders are not suitable for trigger purposes.

TrigIn input

The TrigIn switching input is equipped with an internal pull-up resistor of 15 kOhm. An open input is identified as High.

Trigger sources can be switching contacts, transistors (NPN, N-channel FET) and SPS outputs.

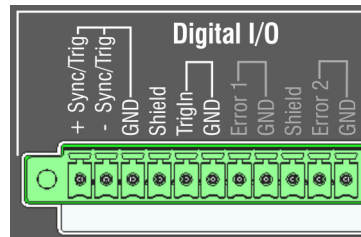

Electrical properties

- Programmable logic (TTL/HTL),
- TTL: Low level ≤ 0.8 V; High level ≥ 2 V
- HTL: Low level ≤ 3 V; High level ≥ 8 V (max. 30 V),
- Minimum pulse width 50 μ s

4.4.11 Encoder Inputs

Two encoders can be connected simultaneously and powered with 5V using the 15-pin HD-sub connector.

Each encoder provides A, B and N signals (zero pulse, reference, index). The maximum pulse frequency is 1MHz.

RS422 level (symmetrical) for A, B, N

Encoder supply 5 V: each 5 V, max. 300 mA

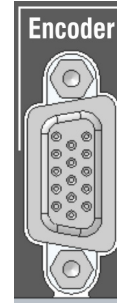
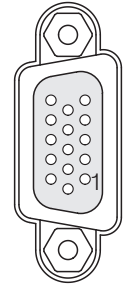

Fig. 18 15-pin HD connector

Encoder	Pin	Signal	Encoder	Pin	Signal
1	1	GND ENC1	2	11	GND ENC2
	5	A1+		3	A2+
	4	A1-		2	A2-
	10	N1+ ¹		8	N2+ ¹
	9	N1- ¹		7	N2- ¹
	15	B1+		13	B2+
	14	B1-		12	B2-
	6	ENC U _p +5V		6	ENC U _p +5V
Connector housing		Controller housing		Cable shield	



View on solder pin side male cable connector

Fig. 19 Pin assignment encoder inputs

➡ Use a shielded cable of less than 3 m. Connect the cable shield to the cover.

Connection requirements

The encoders must provide symmetrical RS422 signals.

If the encoder has no RS422 outputs, we recommend a level converter SU4 (3 channels TTL/HTL to RS422) between trigger signal source and controller.

Both encoders can be supplied with the controller voltage ENC U_p +5V and loaded with a maximum of 300 mA. When using the power supply of the 15-in HD socket, the cable length to the encoder must be less than 3 m. When the encoder is supplied externally, cable lengths up to 30 meters are possible.

The inputs are not electrically isolated from the supply voltage.

1) If the encoders are operated without reference tracks (N), the reference tracks (N) can be used as a third encoder.

4.5 Sensor Cable, Optical Fiber

Sensor and controller are connected through an optical fiber.

- Do not shorten or lengthen the optical fibers.
- Do not pull or hold the sensor on the optical fiber.
- The optical fibers has a diameter of 50 μm .

Do not soil the connectors, because this would lead to particle deposition in the controller and therefore to strong loss of light. Cleaning of the connectors requires the corresponding know-how and a fiber microscope for control.

Basic Rules

NOTICE

Avoid

- any contamination of the connector, e. g. dust or finger prints, and frequent connecting and disconnecting
- any mechanical stress of the fiber (kinking, squeezing, pulling, twisting, knotting etc.)
- strong bending of the fiber. as the optical fiber is damaged thereby rapidly and this leads to permanent damage through micro-cracks

Please never underrun the allowed bending radius.

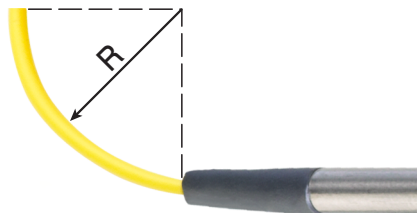

Fixed:
R = 30 mm or more

Flexible:
R = 40 mm or more

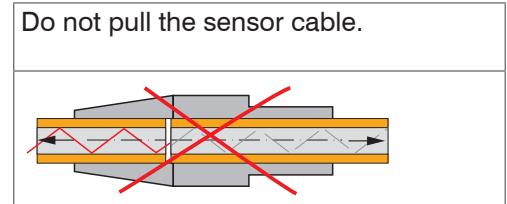
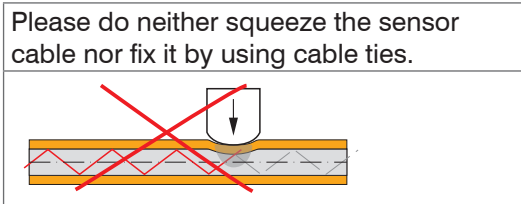
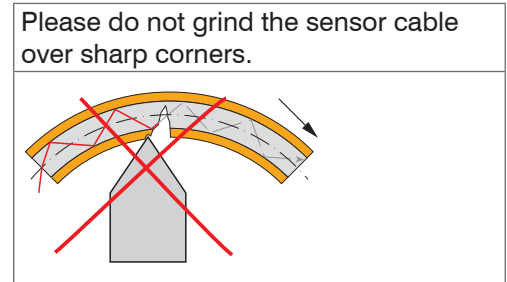
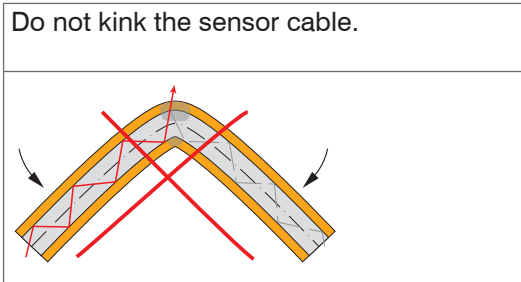

Miniature sensors IFS2402, hybrid sensors IFS2403

The optical fibers are fixed to the sensor and cannot be replaced. Repairs involve reducing the cable length and a new connector through the manufacturer only.

Standard sensors IFS2405

The **sensor cable is connected to the sensor**. Sensor cables may be up to 50 m long. Cables for drag chain use and cables with protective metal tubing are available, [see A 1](#). A damaged sensor cable can be replaced, [see 8.2](#).

Connecting the sensor cable to the controller

- ➔ Remove the dummy connector from the green optical fiber socket *Sensor 1/2*¹ on the controller.
- ➔ Plug the sensor cable (green connector, E2000/APC) into the optical fiber socket, and ensure that the sensor connector is aligned correctly.
- ➔ Push the sensor connector into the socket until it locks.

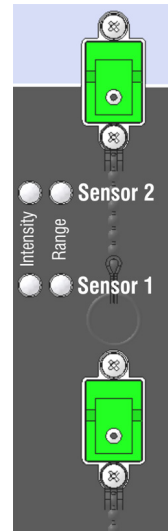

1) The sensor connector Sensor 2 is available on controller IFC2422 and IFC2466 only.

Disconnecting the sensor cable from the controller

- ➔ Push the sensor connector's release lever down, and pull the sensor connector out of the socket.
- ➔ Replace the dummy connector.

NOTICE

Close the optical inputs and outputs with protective caps when no fiber cable is connected.

4.6 Sensors

4.6.1 Dimensions IFS2402 Sensors

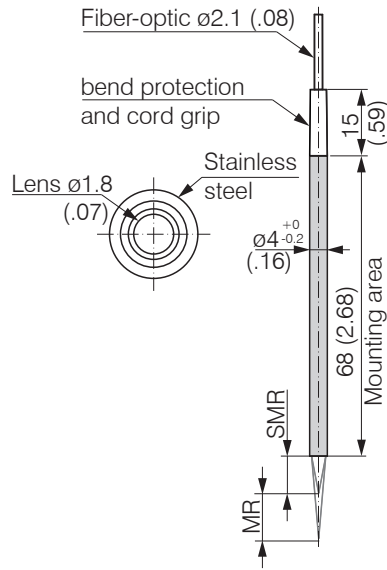

IFS2402-0,5/1,5/4/10

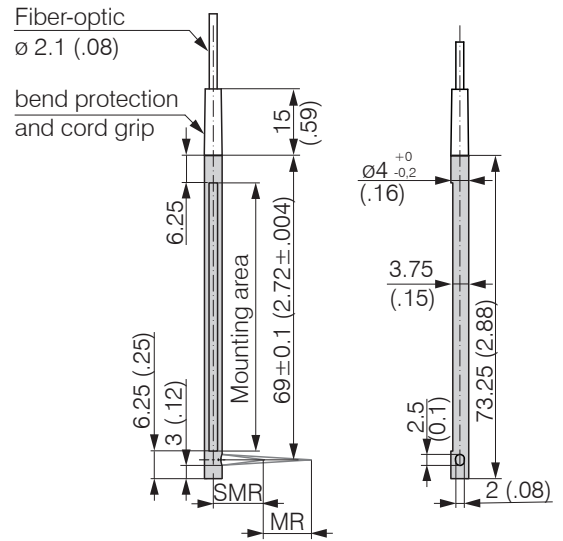

IFS2402/90-1,5/4/10

MR = Measuring range
SMR = Start of measuring range

4.6.2 Dimensions IFS2403 Sensors

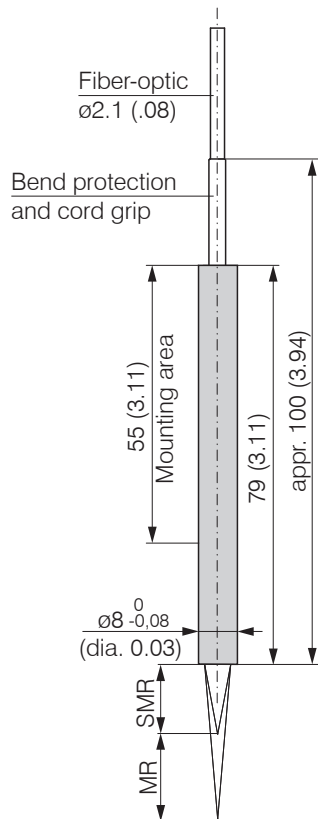

IFS2403-0,4/1,5/4/10

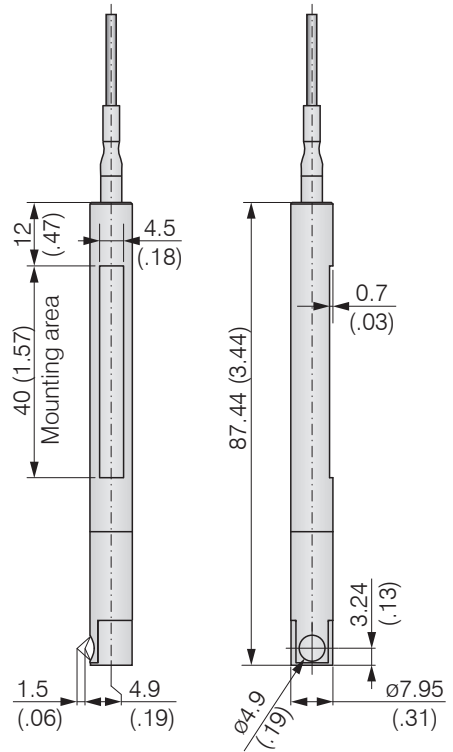

IFS2403/90-1,5

Dimension in mm (Inch)

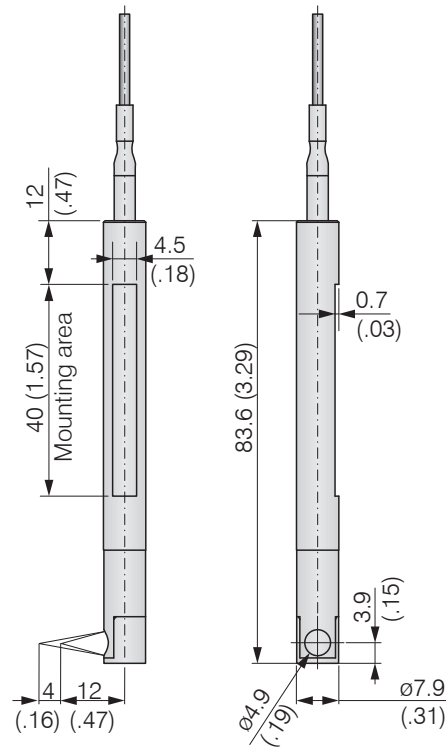

IFS2403/90-4

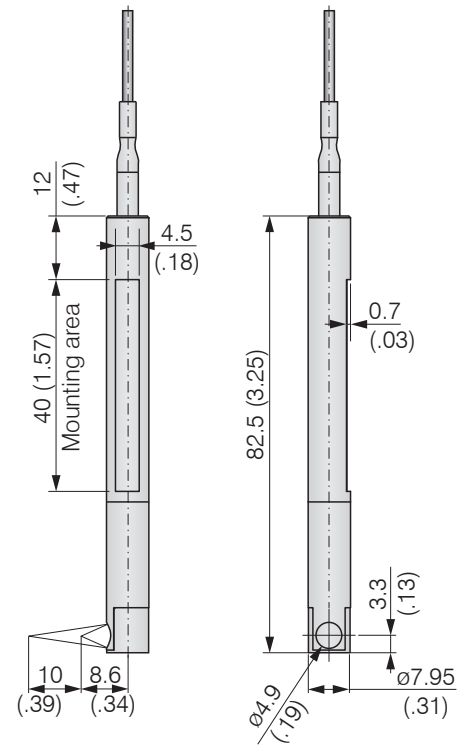

IFS2403/90-10

MR = Measuring range
 SMR = Start of measuring range

4.6.3 Dimensions IFS2404 Sensors

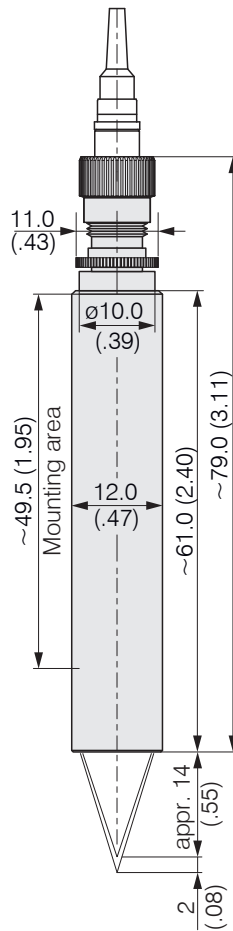

IFS2404-2(001)

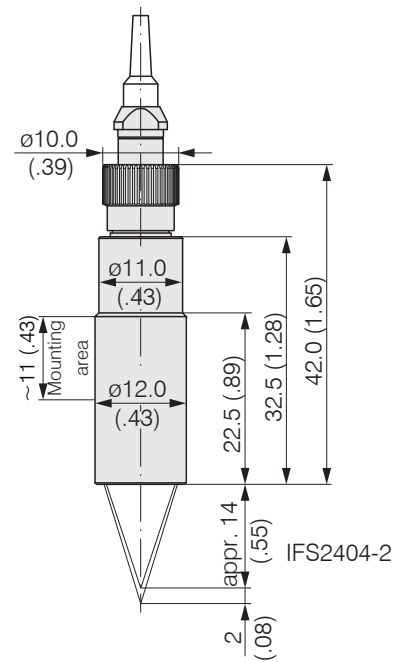

IFS2404-2

Dimension in mm (Inch)

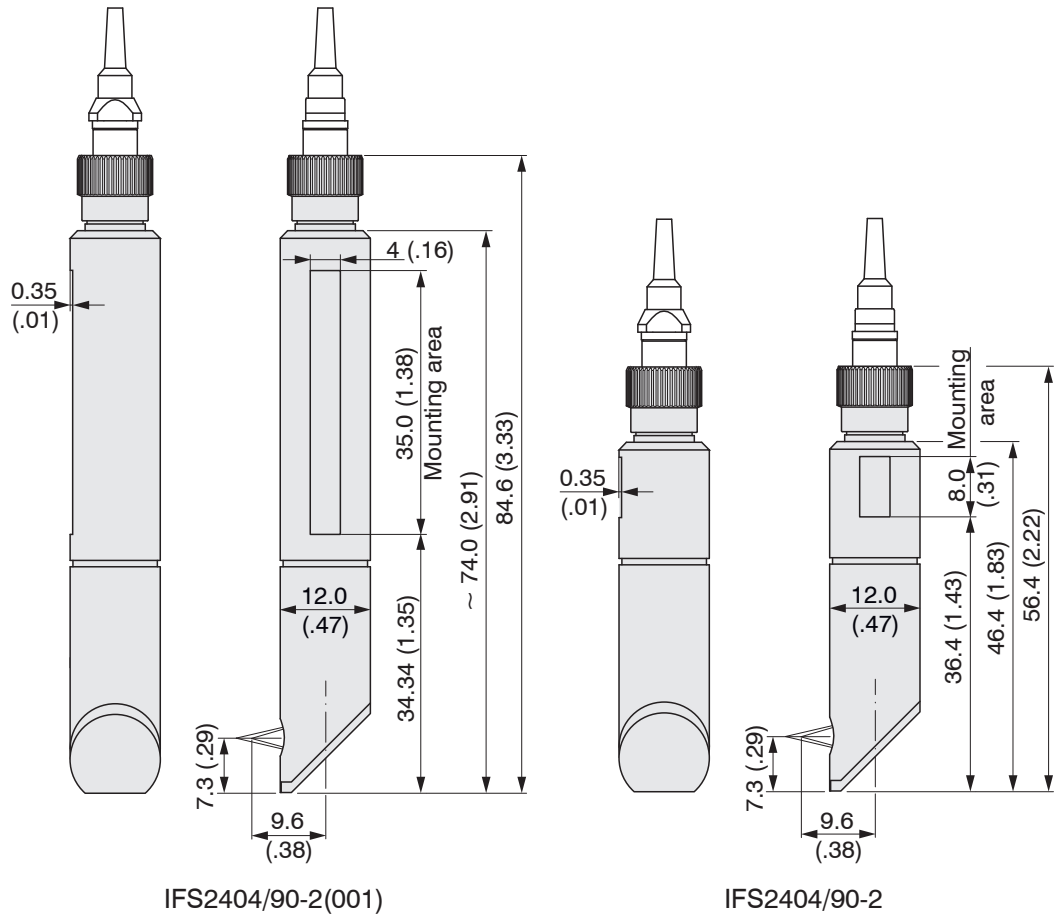

4.6.4 Dimensions IFS2405 Sensors

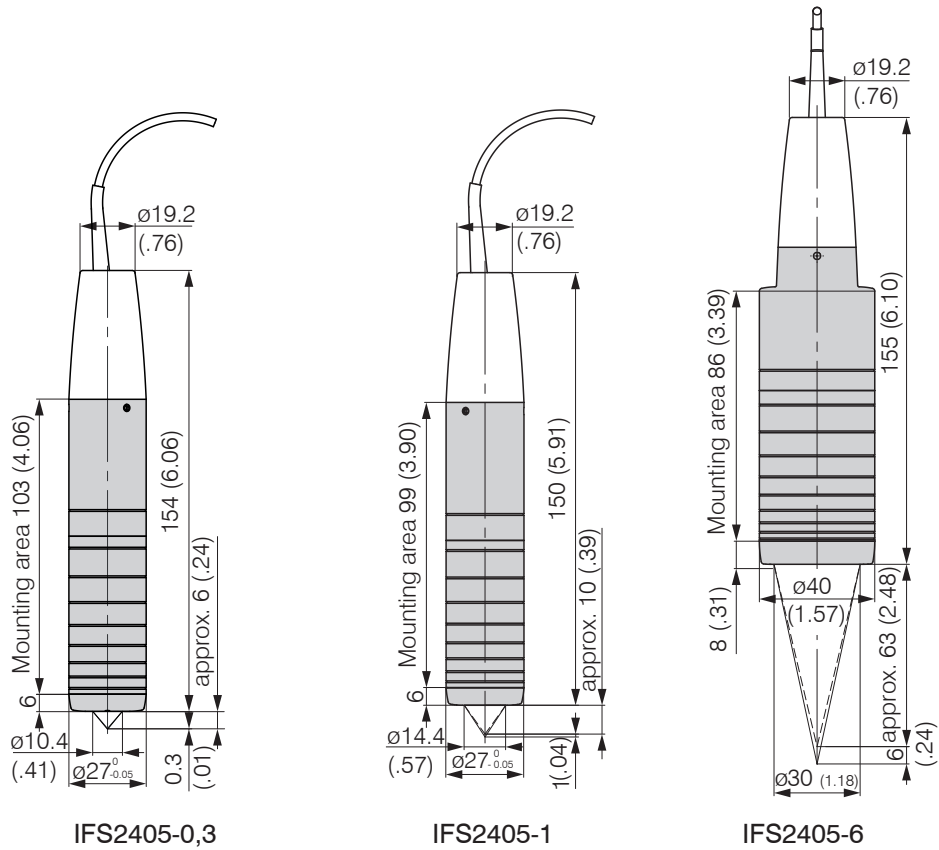

Dimension in mm (Inch)

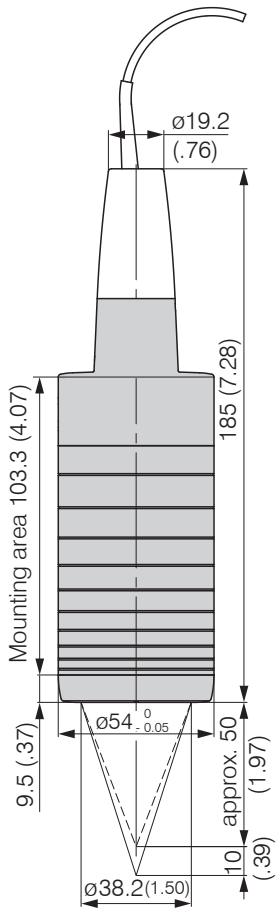

IFS2405-10

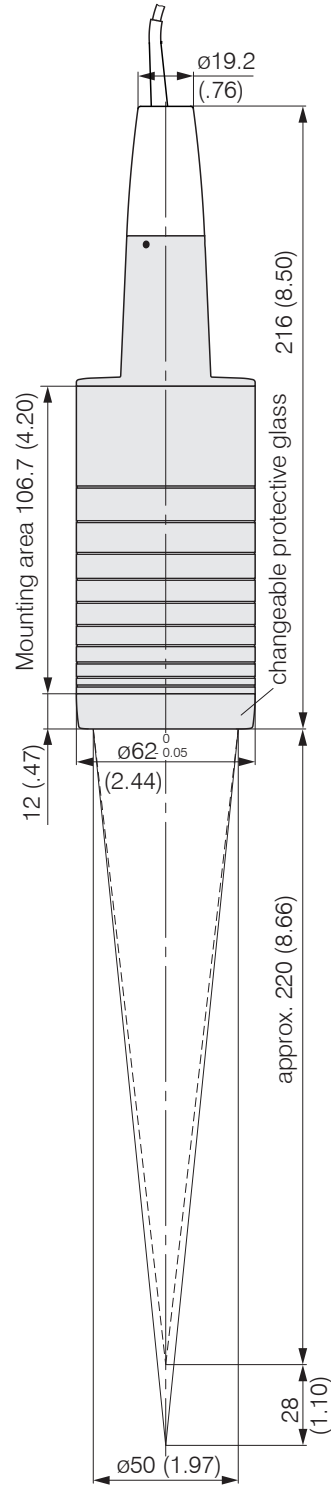

IFS2405-28

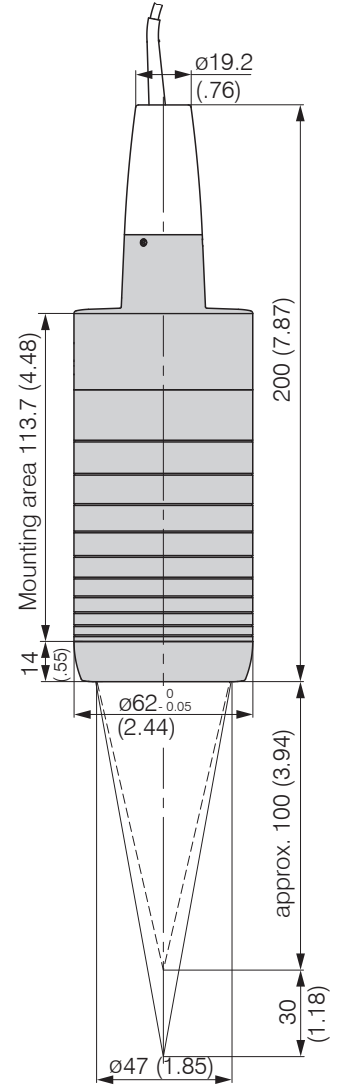

IFS2405-30

Dimension in mm (Inch)

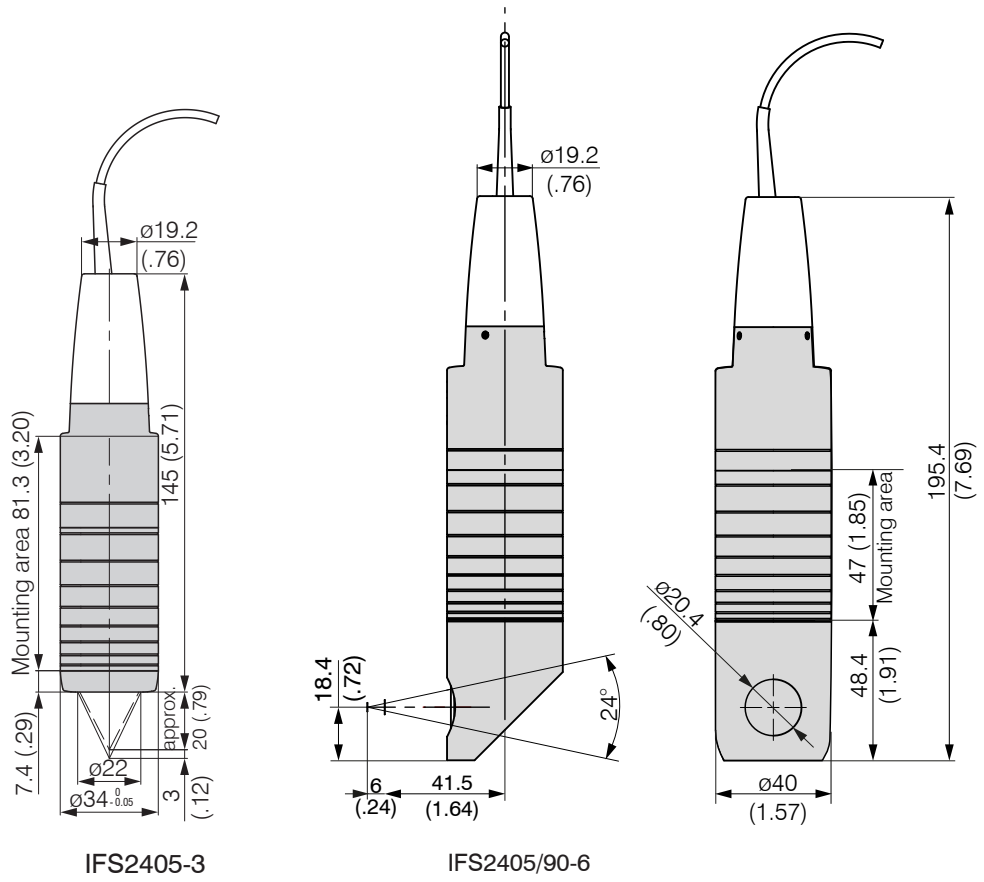

Dimension in mm (Inch)

4.6.5 Dimensions IFS2406 Sensors

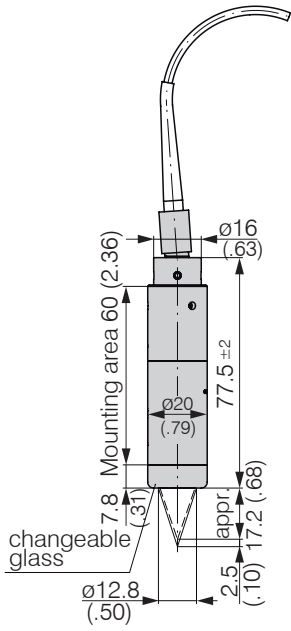

IFS2406-2,5/VAC(003)

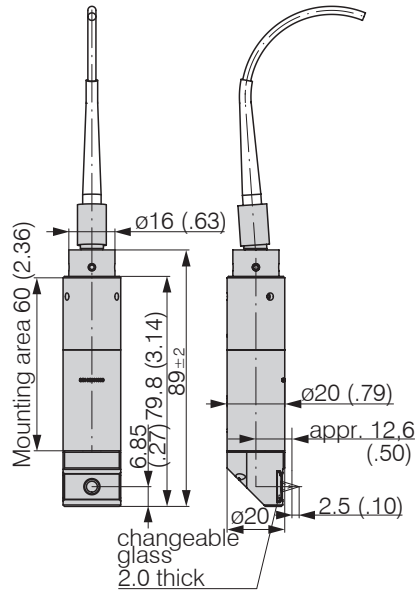

IFS2406/90-2,5/VAC(001)

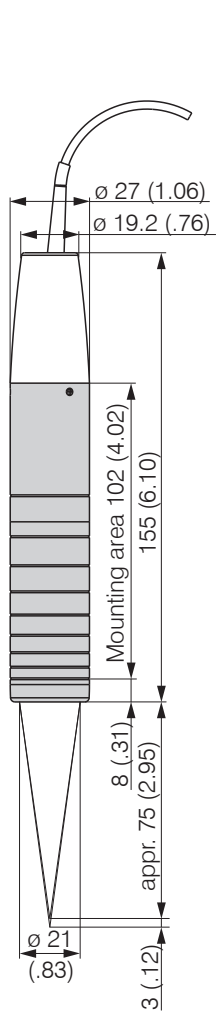

IFS2406-3

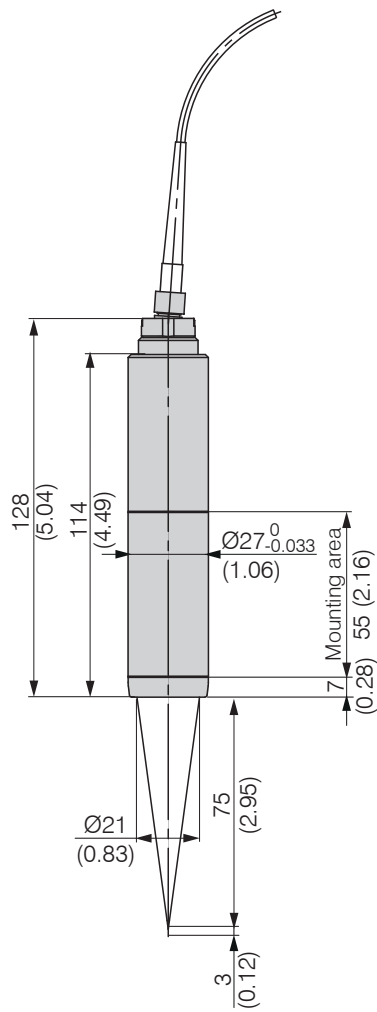

IFS2406-3/VAC(001)

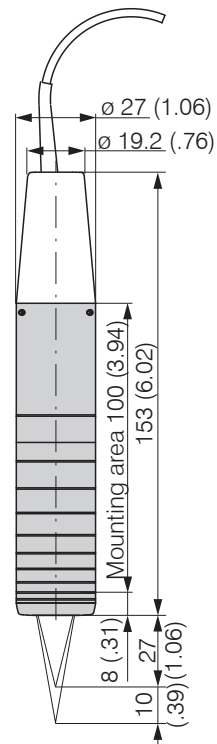

IFS2406-10

Dimension in mm (Inch)

4.6.6 Dimensions IFS2407 Sensors

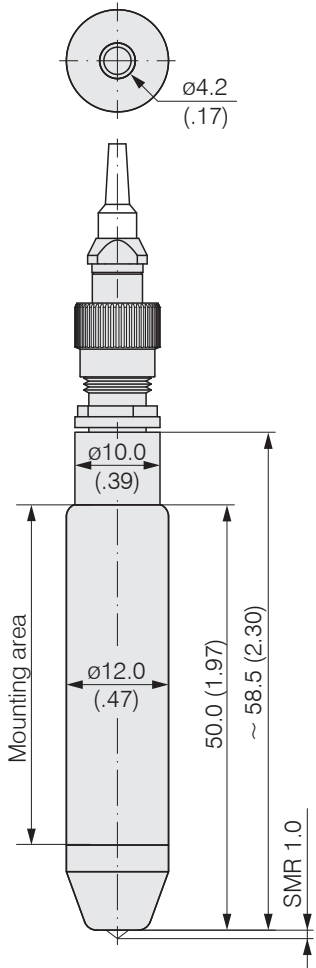

IFS2407-0,1

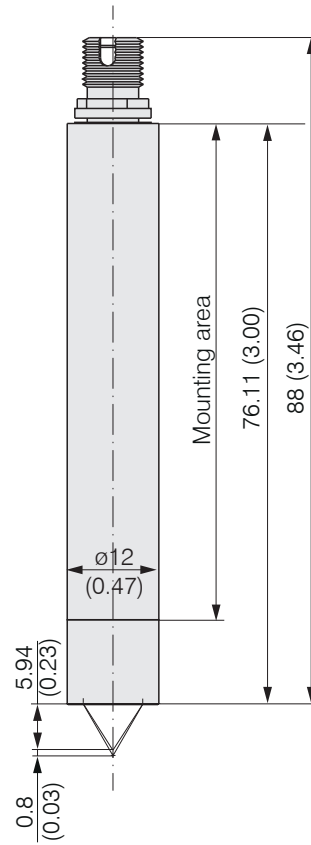

IFS2407-0,8

Dimension in mm (Inch)

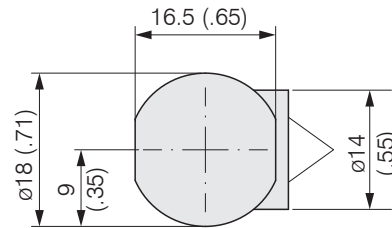

IFS2407/90-0,3

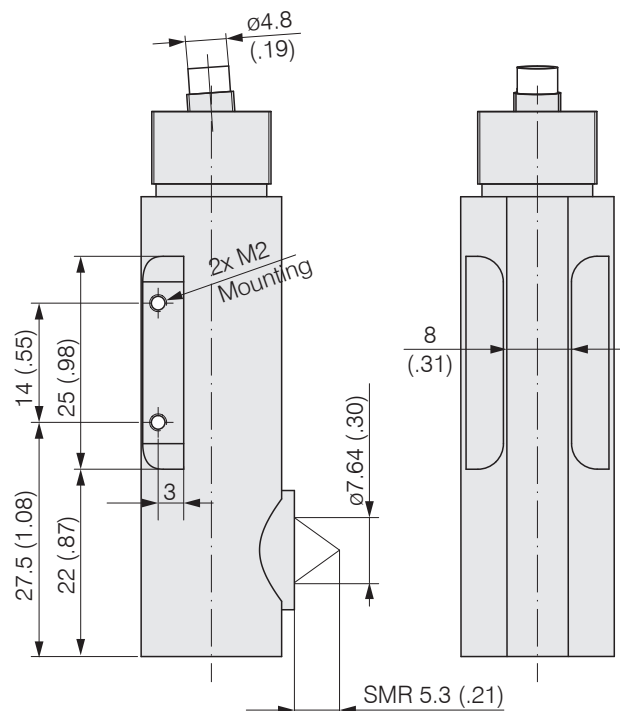
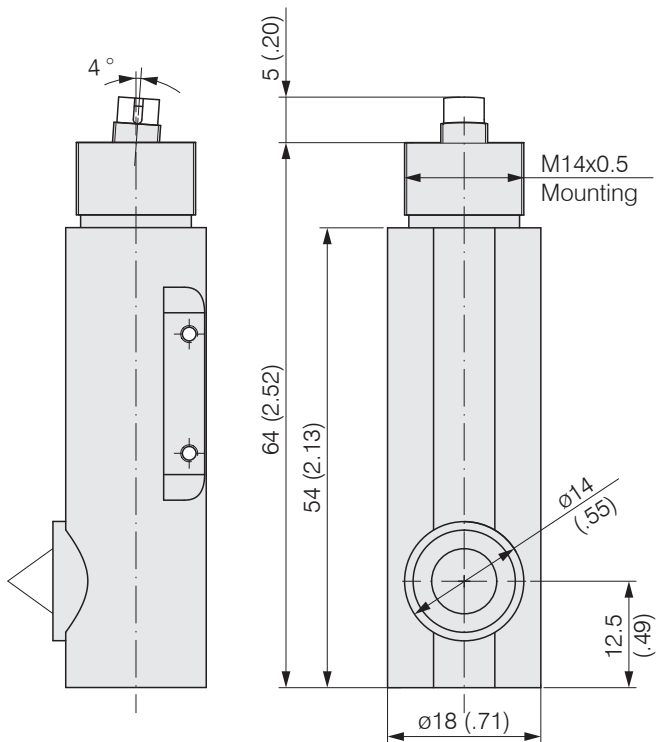

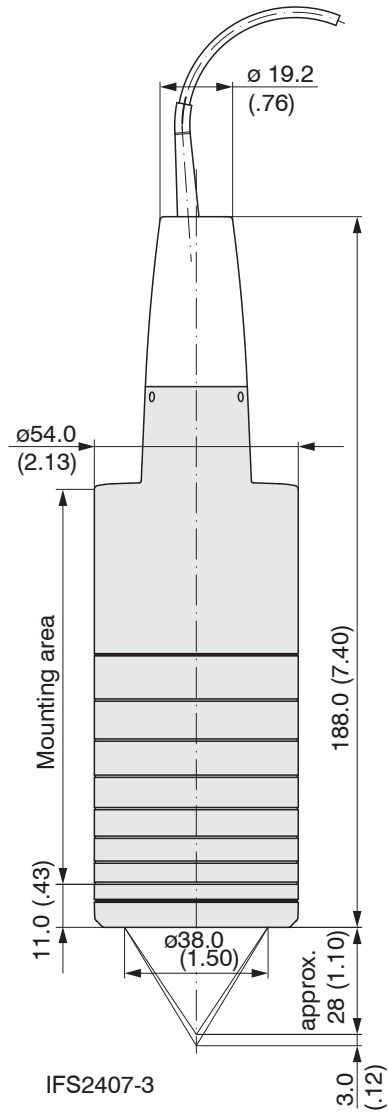

4.6.7 Start of Measuring Range

A base distance (SMR) must be maintained for each sensor.

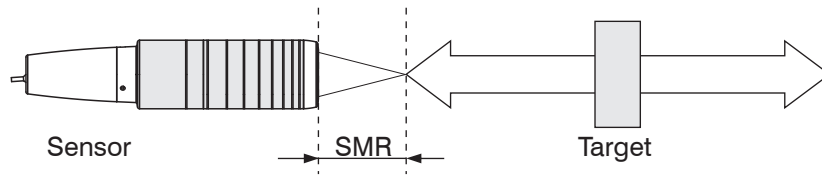

Fig. 20 Start of measuring range (SMR), the smallest distance between the sensor surface and the target.

SMR = Start of measuring range, approximate values

Sensor	SMR
IFS2402-0,5	1.7 mm
IFS2402-1,5	0.9 mm
IFS2402/90-1,5	2.5 mm ¹
IFS2402-4	1.9 mm
IFS2402/90-4	2.5 mm ¹
IFS2402-10	2.5 mm
IFS2402/90-10	3.5 mm ¹

Sensor	SMR
IFS2403-0,4	2.8 mm
IFS2403-1,5	8.1 mm
IFS2403/90-1,5	4.9 mm ¹
IFS2403-4	14.7 mm
IFS2403/90-4	12 mm ¹
IFS2403-10	11 mm
IFS2403/90-10	8.6 mm ¹

Sensor	SMR
IFS2404-2	14 mm
IFS2404-2(001)	14 mm
IFS2404/90-2	9.6 mm ¹
IFS2404/90-2(001)	9.6 mm ¹

Sensor	SMR
IFS2405-0,3	6 mm
IFS2405-1	10 mm
IFS2405-3	20 mm
IFS2405-6	63 mm
IFS2405/90-6	41 mm ¹
IFS2405-10	50 mm
IFS2405-28	220 mm
IFS2405-28/VAC(001)	220 mm
IFS2405-30	100 mm

Sensor	SMR
IFS2406-2,5/VAC(003)	17.3 mm
IFS2406/90-2,5/VAC(001)	12.6 mm ¹
IFS2406-3	75 mm
IFS2406-3/VAC(001)	75 mm
IFS2406-10	27 mm
IFS2406-10/VAC(001)	27 mm

Sensor	SMR
IFS2407-0,1	1.0 mm
IFS2407/90-0,3	5.3 mm
IFS2407-3	28 mm

1) Start of measuring range measured from sensor axis.

4.6.8 Mounting, Installation Bracket

4.6.8.1 General

The sensors of series IFS240x are optical sensors that operate in micrometers.

i Please ensure careful handling during installation and operation!

Mount the sensors with an outer clamp. This type of sensor installation ensures the highest level of reliability because the sensor's cylindrical cover is clamped over a relatively large area. It must be used in complex installation environments, such as machines, production systems etc.

4.6.8.2 IFS2402 Sensors

▶ Use an installation bracket MA2402 to mount IFS2402 sensors.

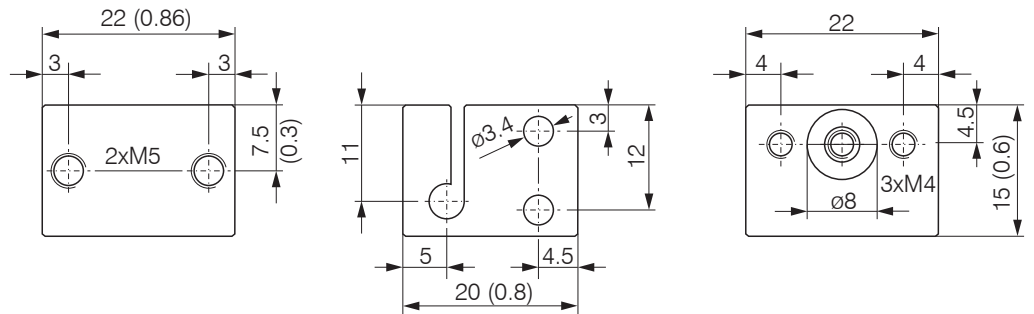

Fig. 21 MA2402-4 installation bracket

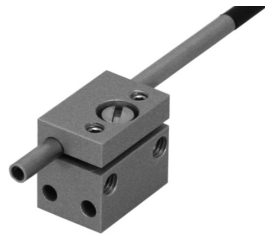

Fig. 22 Outer clamps with MA2402 for IFS2402 sensors

4.6.8.3 IFS2403 Sensors

▶ Use an installation bracket MA2403 to mount IFS 2403 sensors.

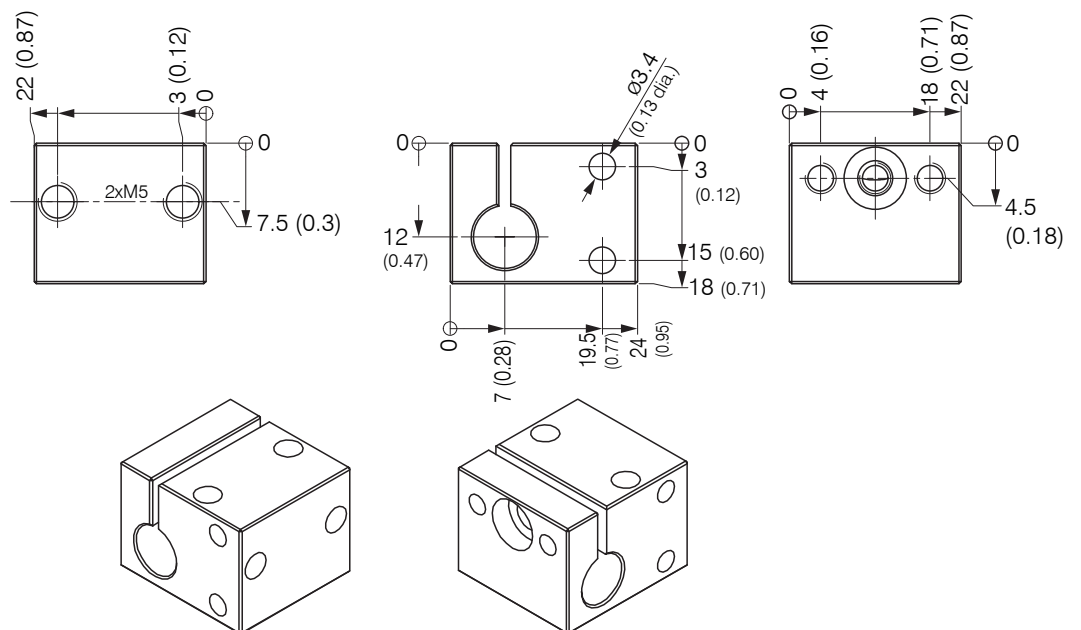
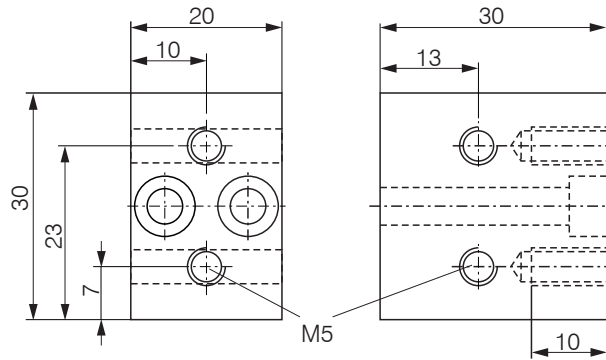

Fig. 23 MA2403 installation bracket

Dimension in mm (Inch)

4.6.8.4 IFS2405, IFS2406 and IFS2407 Sensors

➡ Use an installation bracket MA240x to mount IFS2405 and IFS2406 sensors.



Installation ring		Dimension A	Dimension B	Dimension C	Sensor
MA2400-27		ø27	ø46	19.75	IFS2405-0.3 IFS2405-1 IFS2406-3 IFS2406-10
MA2405-34		ø34	ø50	22	IFS2405-3
MA2405-40		ø40	ø56	25	IFS2405-6
MA2405-54		ø54	ø70	32	IFS2405-10 IFS2407-3
MA2405-62		ø62	ø78	36.5	IFS2405-28 IFS2405-30
MA2406-20		ø20	ø36	14.5	IFS2406-2,5

Fig. 24 MA240x installation block and ring



Fig. 25 Outer clamps with installation bracket MA240x for IFS2405 and IFS2406 sensors

Dimension in mm (Inch)

4.6.8.5 IFS2404 and IFS2407 Sensors

➡ Use an installation bracket MA2404-12 to mount IFS2404-2, IFS2404/90-2, IFS2407-0,1 and IFS2407-0,8 sensors.

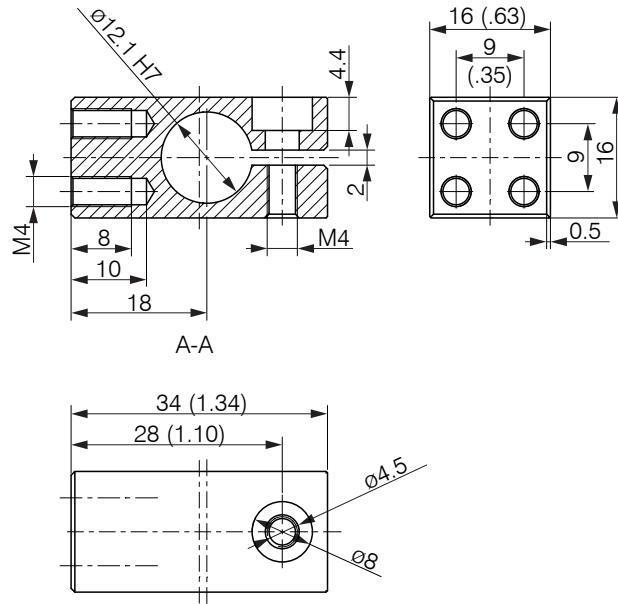

Fig. 26 Outer clamps with installation bracket MA2404-12 for IFS2404-2, IFS2404/90-2, IFS2407-0,1 and IFS2407-0,8 sensors, dimension in mm (Inch)

➡ Use the mounting area and two screws M2 or the mounting thread M14x0,5 to mount IFS2407/90 sensors.

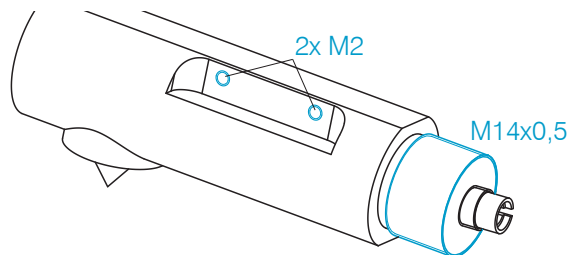

Fig. 27 Mounting for series IFS2407/90-0,3 sensors

4.6.8.6 Adjustable Mounting Adapter JMA-xx

The JMA-xx adjustable mounting adapter is compatible with numerous confocalDT sensor models.

You can find more information on these accessories in the Appendix, see A 3.

5. Operation

5.1 Commissioning

- Connect the controller to a voltage supply, see 4.4.4.
- Connect the sensor and the controller with the optical fiber (sensor cable), see 4.5.

When the controller has been switched on it initializes. The measuring system is ready after approx. 10 seconds. To ensure precise measurements, let the measuring system warm up for about 60 minutes. The system can be configured through web pages that are integrated into the controller or using commands, see A 5. We recommend configuring the controller through the web pages.

5.2 Operation Using Ethernet

5.2.1 Requirements

Dynamic web pages are generated in the controller which contain the current settings of the controller and the peripherals. Operation is only possible while there is an Ethernet connection to the controller.

To support a basic first commissioning of the sensor, the sensor is set to a direct connection. If you have configured your browser to access the internet via a proxy server, in the browser settings you will need to add the IP address of the controller to the list of addresses which should not be routed through the proxy server. The MAC address of the unit can be found on the nameplate of the controller and on the test certificate calibration report.

- You need a HTML5 browser. Use one of the browsers below:
- | | | |
|------------------------|----------------------|--------------------|
| Internet Explorer 10.0 | Mozilla Firefox 19.0 | Google Chrome 25.0 |
|------------------------|----------------------|--------------------|



Direct connection to PC, controller with static IP (Factory setting)		Network
PC with static IP	PC with DHCP	Controller with dynamic IP, PC with DHCP
<ul style="list-style-type: none"> ➤ Connect the controller to a switch (intranet). Use a LAN cable with RJ-45 connectors. 	<ul style="list-style-type: none"> ➤ Connect the controller to a switch (intranet). Use a LAN cable with RJ-45 connectors. 	<ul style="list-style-type: none"> ➤ Connect the controller to a switch (intranet). Use a LAN cable with RJ-45 connectors.
<ul style="list-style-type: none"> ➤ Start the sensorTOOL.exe program. This program is available online at https://www.micro-epsilon.com/download/software/sensorTOOL.exe. ➤ Click the  button. Select the designated controller from the list. In order to change the address settings, click the button <code>Configure sensor IP</code>. <ul style="list-style-type: none"> • Address type: static IP address • IP address: 169.254.168.150 ¹ • Subnet mask: 255.255.0.0 ➤ Click the button <code>Apply</code>, to transmit the changes to the controller. ➤ Click the button <code>Open Website</code> to connect the controller with your default browser. <p><small>1) Requires that the LAN connection on the PC uses, for example, the following IP address: 169.254.168.1.</small></p>	<p>Wait until Windows has established a network connection (Connection with limited connectivity).</p> <ul style="list-style-type: none"> ➤ Start the sensorTOOL program. ➤ Click the  button. Select the designated controller from the list. ➤ Click the button <code>Open Website</code> to connect the controller with your default browser. 	<ul style="list-style-type: none"> ➤ Enter the sensor in the DHCP / register the controller in your IT department. <p>The controller gets assigned an IP address from your DHCP server. You can check this IP address with the sensorTOOL program.</p> <ul style="list-style-type: none"> ➤ Start the sensorTOOL program. ➤ Click the  button. Select the designated controller from the list. ➤ Click the button <code>Open Website</code>, to connect the controller with your default browser. <p>Alternatively: If DHCP is used and the DHCP server is linked to the DNS server, access to the controller via a host name of the structure „IFC242x_SN<serial number>“ is possible (where x = 21 for IFC2421, x = 22 for IFC2422, x = 65 for IFC2465, x = 66 for IFC2466).</p> <ul style="list-style-type: none"> ➤ Start a web browser on your PC. To achieve a IFC2421 with the serial number “01234567”, type in the address bar on your browser „IFC2421_SN01234567“.

Fig. 28 Options for connecting to a LAN

5.2.2 Access via Web Interface

Interactive web pages you can use to configure the controller are now displayed in the web browser. The controller is active and supplies measurement values.

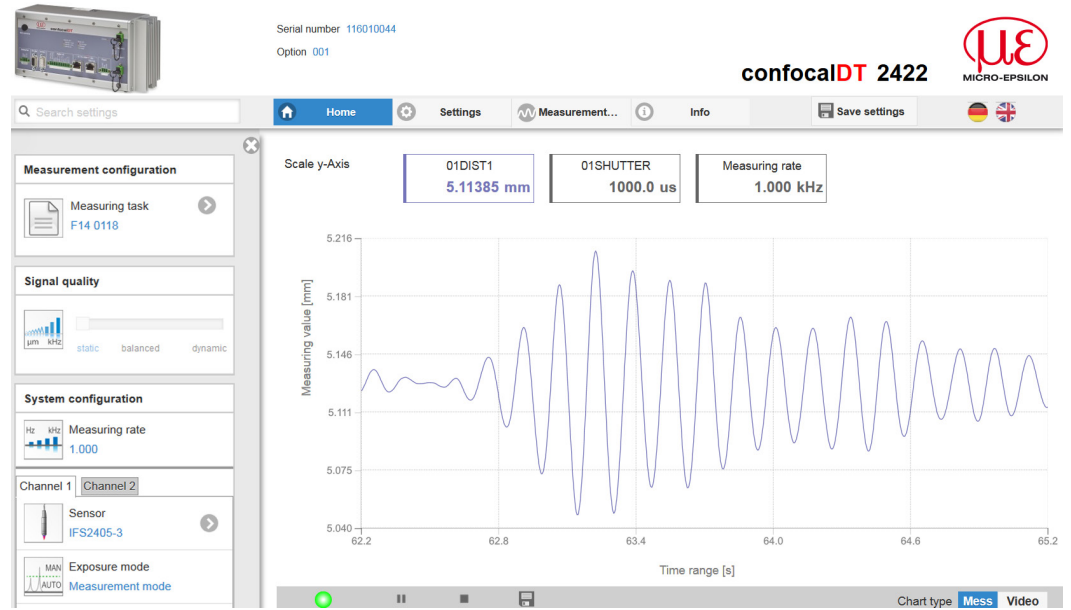

Fig. 29 First interactive web page after calling the IP address

The horizontal navigation includes the functions below:

- The search function permits time-saving access to functions and parameters.
- Home. The web interface automatically starts in this view with measurement chart, Configuration and Signal quality.
- Settings. This menu includes all sensor parameters, [see 6](#).
- Measurement chart. Measurement chart with digital display or overlay of the video signal.
- Info. Includes information about the sensor, such as measuring range, serial number and software status.
- Web interface language selection

All settings on the web page are applied immediately in the controller.

Parallel operation with web browser and ASCII commands is possible; the last setting applies.

The appearance of the web pages may vary depending on functions and peripherals. Dynamic help text with excerpts from the operating instructions supports you during sensor configuration.

5.3 Select a Sensor

Controller and sensor(s) are matched at the factory.

➡ Change to the `Settings > Sensor` menu.

➡ Select the connected sensor for each channel from the list.

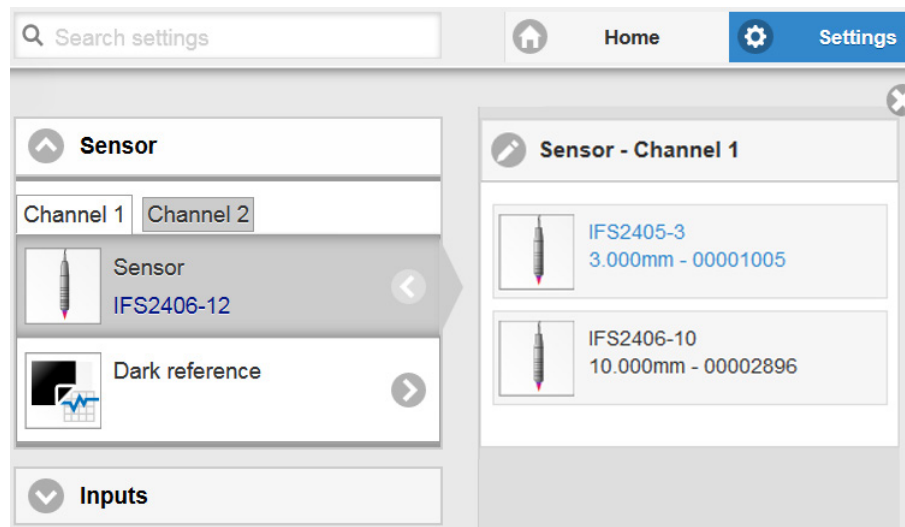

The calibration data of up to 20 different sensors can be stored in the controller. Calibration is done at factory only.

5.4 Button Multifunction

The Multifunction button of the controller has several functions, e.g. dark reference and light source operation.

The dark reference feature is assigned to this button per default. The assignment can be changed in Settings > Inputs. Changing the assignment requires the Expert authorization.

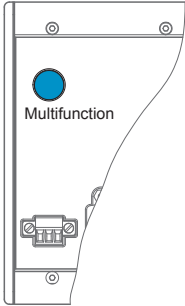
	Function 1	Dark reference	Starts dark reference correction for Sensor 1 or Sensor 2
	Function 2	Mastering Reset Mastering	Starts or stops the master measurement of the selected signals
		LED	Turns the light source on/off for Sensor 1 or Sensor 2
		Inactive	Key has no function

The functions can be allocated to the individual time frames, see A 5.3.16. The time intervals are indicated by LED flashing/lighting

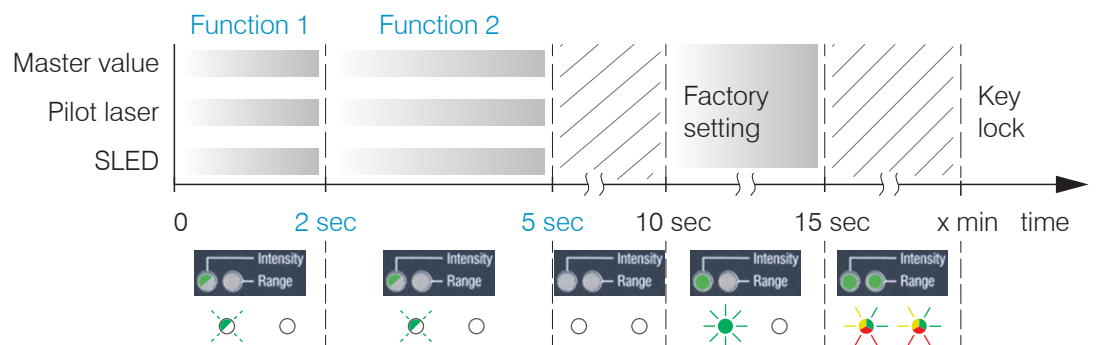

Fig. 30 Button press duration

5.5 Dark Reference

This adjustment must be carried out after every sensor change. Dark referencing is sensor-dependent and is stored separately in the controller for each sensor. Therefore, you need to connect the required sensor and select Settings > Sensor menu, before you start dark referencing.

The controller requires a warm-up time of approx. 30 minutes before performing dark reference.

Step-by-Step procedures:

➡ Remove the target from the measuring range, or cover the sensor surface with a piece of dark paper.

i For dark referencing, no object must be within the measuring range, and no ambient or external light must reach the sensor.

➡ On the controller, press the Multifunction button¹, or click the Start button on the Settings > Sensor > Dark reference web page.

The functions of the Multifunction button are explained in Button Multifunction, see 5.4.

The Intensity and Range LEDs will start flashing, and the sensor captures the current dark signal for about 50 seconds.

 Gray shaded fields require a selection.

 *Value* Dark-bordered fields require you to specify a value.

1) After more than 10 seconds, the factory settings will load!

After the dark referencing the dark corrected signal is characterized by an almost smooth waveform directly to the X-axis.

➡ Remove the paper cover from the sensor. The sensor can now be used as normal.

• Repeat the dark referencing at regular intervals.

The current brightness value (as the quotient of the sum of all intensities and the current exposure time), is determined with each new dark reference. If a major change in the previously stored value is detected, this can be interpreted as the degree of contamination, and a warning is given.

You can also ignore this message. However, you should note the current exposure time in the case of time-critical measurements. Then gently clean the face of the sensor cable's E2000 connector. Only use pure alcohol and fresh lens cleaning tissue to do this. Then repeat the dark reference. If nothing changes, the sensor cable can also have become damaged or the fiber connector lying in the controller may become soiled.

Change the sensor cable or submit the whole system for checking.

You can adjust the warning threshold if necessary in the event of contamination by an ASCII command (permissible deviation in %); the factory setting is 50 %, see A 5.3.4.5.

The warning threshold is stored specific to the setup.

5.6 Place Target

➡ Place the target in the midrange.

➡ Do not exceed the maximum tilt angle between sensor and target, see 2.6.

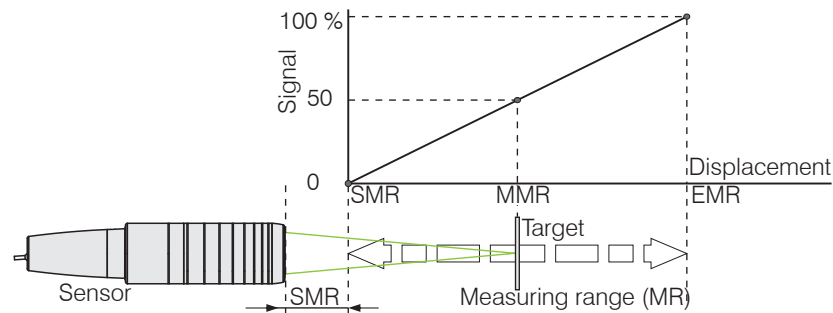

The LED Range on the controller front indicates the position of the target in relation to the sensor.

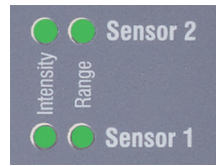

Red flashing	Dark reference acquisition in progress
Red	No target, or target outside the measuring range
Yellow	Target near the midrange
Green	Target within the measuring range

5.7 Measurement Configuration

Common measurement configurations (presets) for various target surfaces are stored on the controller and enable to quickly start the respective measurement task. In a preset the basic features like peak or material selection and calculation functions are already set.

➡ Go to the Home > Measurement configuration menu and start the configuration selection. Select a stored configuration (preset).

Presets:

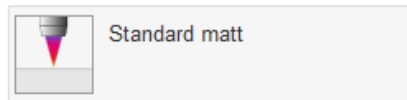

Distance measurement e.g. on ceramics, non-transparent plastics. Highest peak, no averaging, distance calculation.

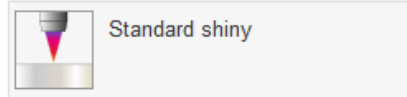

Distance measurement e.g. on metals, polished surfaces. Highest peak, median over 5 values, distance calculation.

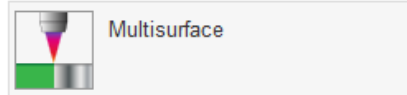

Distance measurement e.g. on PCB, hybrid materials. Highest peak, median over 9 values, distance calculation.

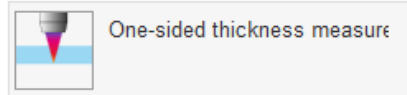

One-sided thickness measurement e.g. of glass, BK7 materials. First and second peak, no averaging, thickness calculation.

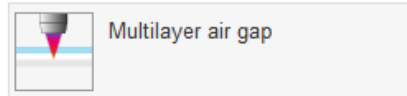

Thickness measurement¹ e.g. of mask under glass. 1. layer BK7, 2. layer air, first and second peak, median over 5 values.

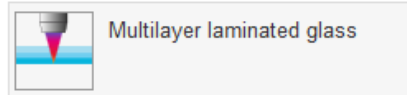

Layer thickness measurement¹ of laminated glass e.g. windshield, 1. layer BK7, 2. layer PC, 3. layer BK7, first and second peak, no averaging.

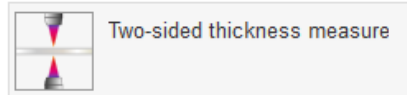

Both sided thickness measurement² of metal. Highest peak, median over 5 values.
Formula: $-1 * 01DIST - 1 * 02DIST1 + 10$

Setups:

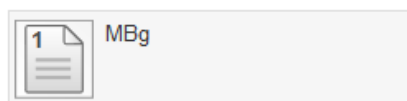

Custom-built settings (setups), see 5.11.

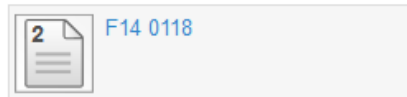

The controller also enables user-specific settings. When saving a changed preset, the web interface displays a dialog which enables the user to define a setup name to avoid accidental overwriting.

➡ Go to the Home > Measurement configuration menu and start the configuration selection. Select a configuration or a setup.

Individual material selection is possible in the Settings > Data recording > material selection menu.

1) Programs available in controller with multi-peak functionality.
2) Possible with controller IFC2422 and IFC2466.

5.8 Video Signal

➡ Go to the `Measurement` chart menu. Show video signal display with `Video`.

The diagram displayed in the large graph window on the right represents the video signal and the receiving row in different states of post processing.

The video signal displayed in the graph window displays the spectral distribution of the pixels in the receiving row. Left 0 % (small distance), and right 100 % (large distance). The corresponding measured value is marked by a vertical line (peak marking).

The diagram starts automatically when the web page is loaded.

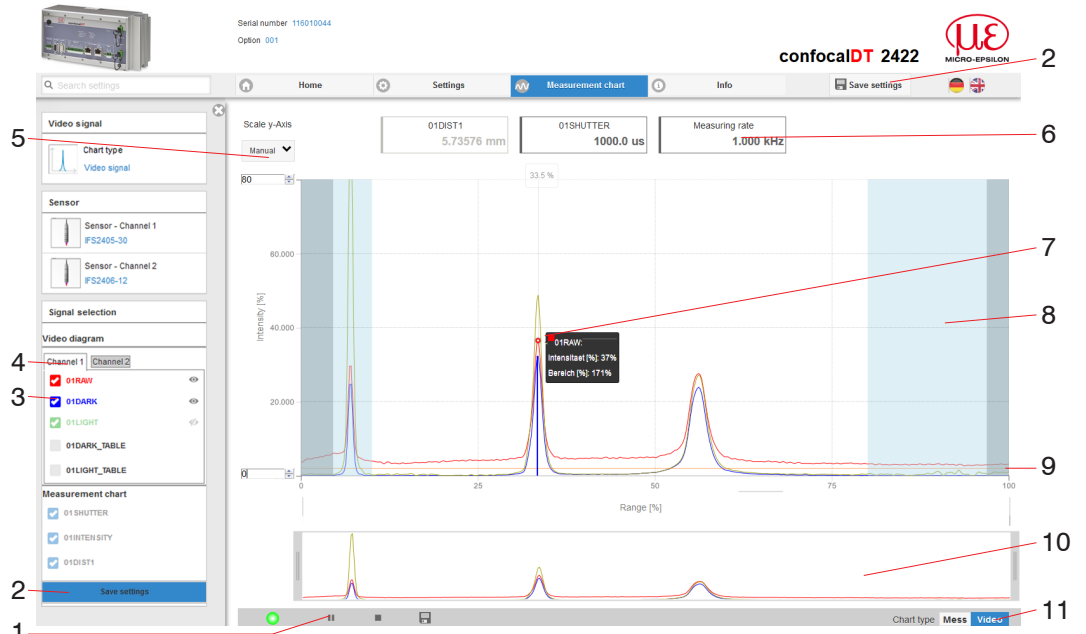



Fig. 31 Video signal web page

The `Video signal` web page includes the following features:

- 1 The LED visualizes the status of the transmission of measured values:
 - green: transmission of measured values is running.
 - yellow: waiting for data in trigger mode
 - gray: transmission of measured values stopped

Data queries are controlled by using the `Play/Pause/Stop/Save` buttons of the measured values that were transmitted. `Stop` stops the diagram; data selection and zoom function are still possible. `Pause` interrupts recording. `Save` opens the Windows dialog box for the name and the location of the file in order to save the selected video signals in a CSV file, which contains all pixels, their (selected) intensities in % and other parameters.

- ➡ Click the button ▶ (Start), for starting the display of the measurement results.
- 2 Changes only take effect after clicking the `Save settings` button.

- 3 In the window on the left, the video graph for channel 1/2 can be enabled or disabled both during and after measuring. Inactive graphs are gray. Click on the check mark to add them. The changes become effective when you save the settings. Use the eye icons  to show or hide the individual signals. The calculation continues in the background.
 - 0xRAW: Raw signal (uncorrected CCD signal)
 - 0xDARK: Dark corrected signal (raw signal minus dark level table)
 - 0xLIGHT: Light source corrected signal (signal which is corrected with the dark signal and the light source table)
 - 0xDARK_TABLE: Dark value table (generated in response to dark referencing)
 - 0xLIGHT_TABLE: Light value table (generated in response to light referencing)
- 4 The chart window shows the video signals of respectively one channel. Use the buttons to switch between the two channels.
- 5 Auto (= automatic scaling) or Manual (= manual setting) allow for scaling the intensity axis (Y axis) of the graph.
- 6 In addition, the current exposure time values and the selected measuring rate are displayed above the graph.
- 7 Mouseover feature. When moving the mouse over the graph, curve points or peak markings are highlighted with a circle symbol while the corresponding intensity is displayed. The corresponding x position is displayed in % above the graph window.
- 8 The linearized range is in the diagram between the gray hatchings and can not be changed. Only peaks of which the centers are in this range can be evaluated. The masked range may be limited if needed. Then an additional pale blue hatching limits the range on the right and on the left side. The peaks remaining in the resulting range are used for evaluation.
- 9 The detection threshold, based on the dark corrected signal, is a horizontal straight line that corresponds to the preset value. It needs to be just high enough that no undesired video signal peak is included in the measurement. An acceptable signal-to-noise ratio requires the threshold to be as low as possible. The detection threshold should not be changed if possible.
- 10 X axis scaling: The diagram displayed above is zoomable with both sliders on the right and on the left side in the lower total signal. Move it sideways also with the mouse in the center of the zoom window (cross arrow).

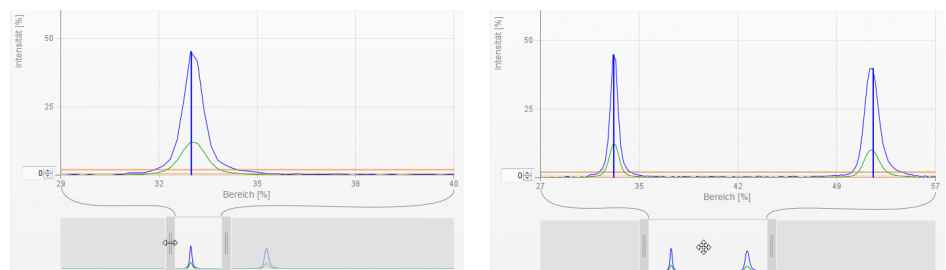

Fig. 32 Slider zoom: one-sided and dragging with cross arrow

- 11 The both buttons allow to change between video and measurement representation.

5.9 Signal Quality

A good measurement result can be achieved with sufficient video signal intensity. Reducing the measuring rate enables longer exposure of the CCD array, therefore leading to high measurement quality.

The `Signal quality` area enables the user to switch between three preset basic settings (Static, Balanced, Dynamic) by mouse click. The effects are immediately displayed in the chart and the system configuration.

➡ Go to the menu Home > Signal quality and adapt the measurement dynamics to the requirements. Check the result in the video signal.

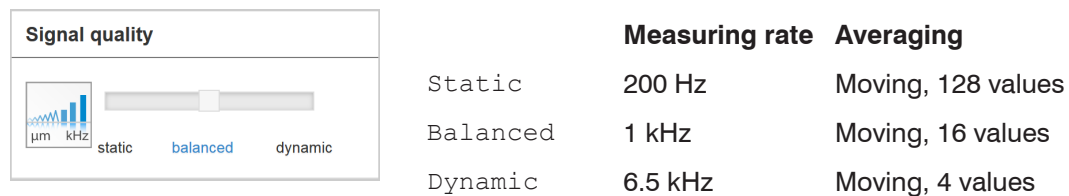

i After the sensor has been started with a user-specific configuration (preset), [see 5.7](#), changing the signal quality is not possible.

5.10 Distance Measurement

- ➡ Align the sensor vertically to the target object.
- ➡ Then, move the sensor (or the target) closer, until you more or less reach the start of measuring range for your sensor.

Once the object is within the sensor's measuring range, the Range LED (green or yellow) on the front of the controller will light up. Or, observe the video signal.

LED	State	Description
Intensity 1/2	Red	Signal is saturated
	Yellow	Signal too low
	Green	Signal is ok
Range 1/2	Red	No target or outside the measuring range
	Yellow	Target in midrange
	Green	Target within the measuring range

Fig. 33 Description of LEDs for distance measurements

After launching Measurement chart > Mess the following web page is displayed. The diagram starts automatically when the web page is reloaded. The diagram in the large window to the right displays the value-time graph.

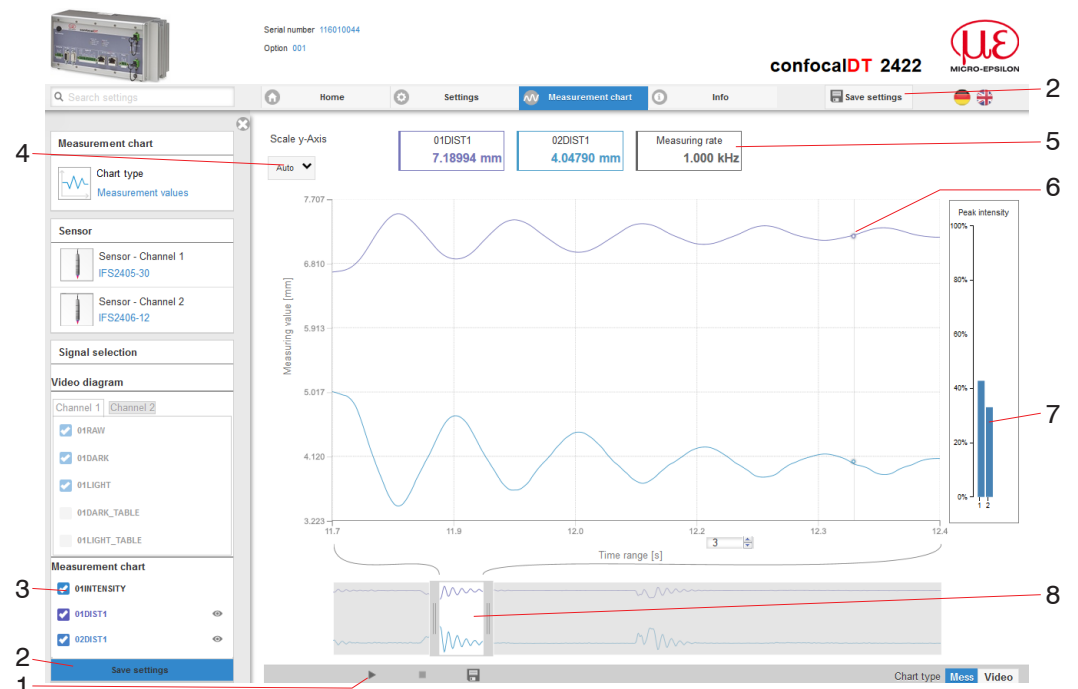



Fig. 34 Measurement web page (distance measurement)

- 1 The LED visualizes the status of the transmission of measured values:
 - green: transmission of measured values is running.
 - yellow: waiting for data in trigger mode
 - gray: transmission of measured values stopped

Data queries are controlled by using the Play/Pause/Stop/Save buttons of the measured values that were transmitted. Stop stops the diagram; data selection and zoom function are still possible. Pause interrupts recording. Save opens the Windows selection dialog for file name and storage location to save the last 10,000 values in a CSV file (separation with semicolon).

- ➡ Click the button ▶ (Start), for starting the display of the measurement results.

- 2 Changes only take effect after clicking the `Save settings` button.
- 3 In the window on the left, the signals for channel 1/2 can be enabled or disabled both during and after measuring. Inactive graphs are gray. Click on the check mark to add them. The changes become effective when you save the settings. Use the eye icons  to show or hide the individual signals. The calculation continues in the background.
 - 0xSHUTTER: Shutter time
 - 0xINTENSITY: Signal quality of the respective peak in the video signal
 - 0xDIST: Chronological signal sequence
- 4 Auto (= automatic scaling) or Manual (= manual setting) allow for scaling the measurement axis (Y axis) of the graph.
- 5 In addition, the values of distance, the current measuring rate and time stamp are displayed in the text boxes above the graph. Errors are displayed as well.
- 6 Mouseover feature while measurement is stopped. When moving the mouse over the graph, curve points are highlighted with a circle symbol while the corresponding values are displayed in the text boxes above the graph. The intensity bars are updated as well.
- 7 The peak intensity is displayed in form of a bar graph.
- 8 X axis scaling: The total signal is zoomable with the slider on the left side during running measurement. The time range can be defined in the input field below the time axis. Once the diagram is stopped, you can use the right slider as well. You may also move the zoom window sideways with the mouse in the center of the zoom window (cross arrow).

5.11 Load / Save Settings

In this menu you can save current device settings to the controller and recall stored settings. You can permanently store eight different parameter sets in the controller.

We recommend saving settings after programming the controller, as the settings will be lost when the controller is switched off. We recommend saving settings after programming the controller, as the settings will be lost when the controller is switched off.

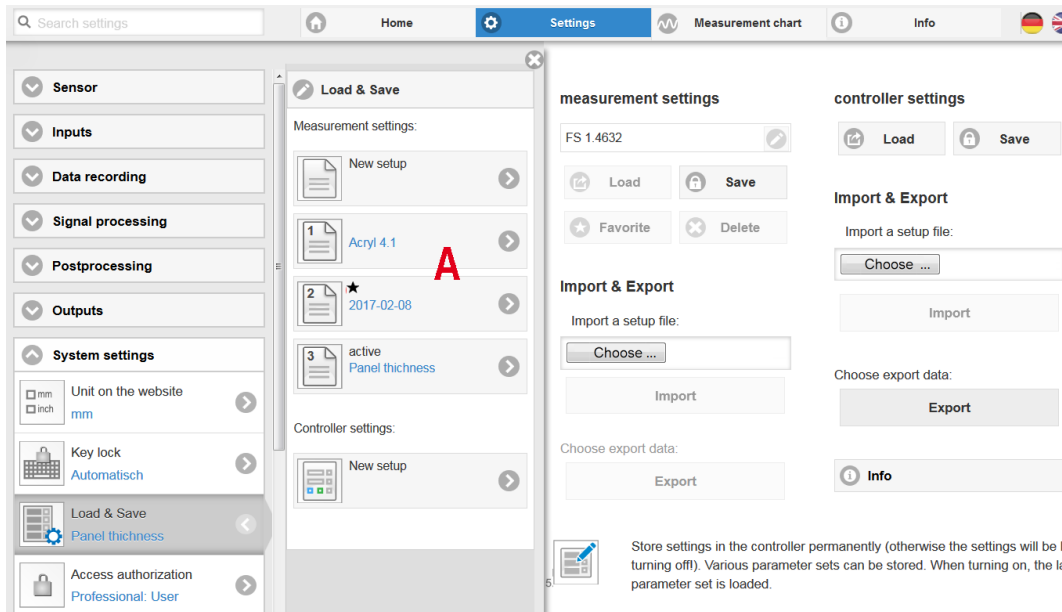
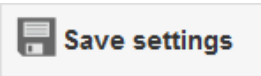



Fig. 35 Setup management

➡ Change to the Settings > System settings > Load & Safe menu.

Manage setups in the controller, possibilities and procedure			
Save settings	Activate existing setup	Save changes in active setup	Define setup after booting
Menu New setup	Menu Load & Safe	Menu bar	Menu Load & Safe
➡ Enter the name for the setup into the field individual name e.g. FS 1.4632 and click the button Save.	➡ Click on the desired setup with the left mouse button, area A. The dialog Measurement settings opens. ➡ Click on the button Load.	➡ Click on the button  	➡ Click on the desired setup with the left mouse button, area A. The dialog Measurement settings opens. ➡ Click on the button Favorite.

The current settings will be available after the controller has been switched off and on.

For a fast saving to the last saved setup use the Save setup button in every preferences page.

i Switching on the controller loads the set of parameters that was last stored in the controller.

Exchange setups with PC/notebook, possibilities	
Safe setup on PC	Load setup from PC
Menu Load & Safe	Menu Load & Safe
➡ Click on the desired setup with the left mouse button, area A. The dialog Measurement settings opens. ➡ Click on the button Export.	➡ Click on New setup with the left mouse button. The dialog Measurement settings opens. ➡ Click on the button Search. A Windows dialog for file selections opens. ➡ Choose the desired file and click on the button Open. ➡ Click on the button Import.

6. Advanced Settings

6.1 Inputs

6.1.1 Synchronization

If several sensors measure the same target synchronously, the controllers may be synchronized with each other. The sync output of the first controller `IFD242x Master` is connected to the sync inputs of the further controller, [see 4.4.9](#).

<i>Master</i>			<i>First controller in the measuring chain; synchronizes any subsequent controllers.</i>
<i>Slave Sync/Trig</i>	Termination	on / off	<i>Controller operates in dependence on the first controller. The terminating resistor must be set on ON for the last controller in the chain.</i>
<i>Slave TrigIn</i>			<i>The entry expects TTL or HTL level enabling external synchronization. The TrigIn input is controlled by an external synchronization source, e.g. a frequency generator. Min. 0.1 ... 6.5 kHz resp. 30 kHz (IFC2465/2466). It is also possible to externally synchronize several controllers in parallel.</i>

If the controllers are operated via an EtherCAT interface, then a synchronization can be realized without a synchronization cable.

6.1.2 Encoder Inputs

A maximum of three encoder values can be assigned to the measured data. They will then be issued and used as trigger conditions. This exact assignment to the measured values is ensured by the fact that exactly the encoder values are output that are exist in half of the exposure time of the measured value (the exposure time may vary due to the control). Tracks A and B make it possible to detect directions. Each of the three encoders can be configured separately. The encoder socket configuration, [see 4.4.11](#).

<i>Encoder 1 / 2</i>	Interpolation	<i>single / double / quadruple resolution</i>
	Max value	<i>Value</i>
	Effect on reference track	<i>no effect / set on first track / set with every track</i>
	Set on value	<i>Value</i>
	Setting encoder value per software	
	Reset the detection of the first marker position	

 Gray shaded fields require a selection.

 *Value* Dark-bordered fields require you to specify a value.

6.1.2.1 Interpolation

Interpolation increases the encoder resolution. The counter reading rises and falls with each interpolated pulse edge.

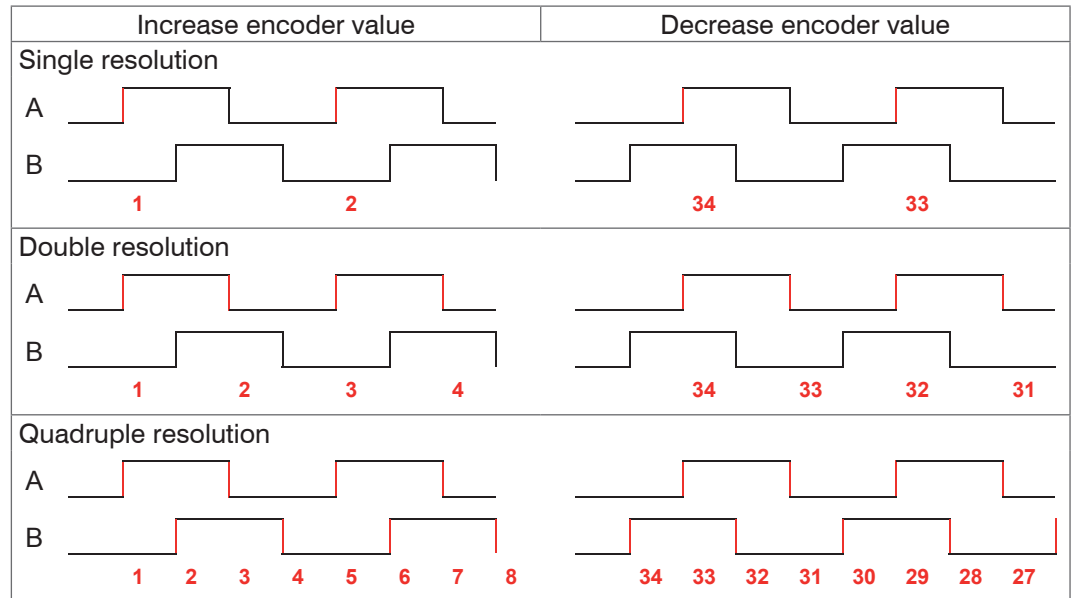

Fig. 36 Pulse sequence encoder signals

6.1.2.2 Maximum Value

If the encoder exceeds the maximum value, the counter is reset to zero. Examples include rotary pulse indicators without a zero-signal (reference track). The maximum counter reading before a reset is 4,294,967,295 ($2^{32}-1$).

6.1.2.3 Effect on the Reference Track

No effect. The encoder counter continues to count; the signal is reset when the controller is switched on or if you click on `Set on value`.

`Set on first track`. Sets the encoder counter to the defined value, if it reaches the first reference mark. It is the first mark after turning on the controller. Without turning off only after pressing the button `Use next mark`.

`Set with every track`. Resets the encoder counter to its starting value at all marker positions or when reaching a marker for a second time (e.g. with traversing movements)

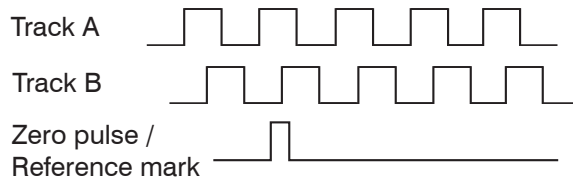

Fig. 37 Reference signal of an encoder

6.1.2.4 Set on Value

The encoder are set to this value

- each time the controller is switched on,
- with the `Set on value` button.

The starting value must be lower than the maximum value and should not exceed 4.294.967.294 ($2^{32}-2$).

6.1.2.5 Reset Reference Mark

Resets the detection of the reference mark.

6.1.3 Abschlusswiderstand

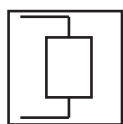

The terminating resistor at the Sync/Trig synchronization input is switched on or off to avoid reflections.

On: With terminating resistor

Off: No terminating resistor

6.2 Data Recording

6.2.1 Measuring Rate

To select the measuring rate click `Settings > Data recording > Measuring rate`. The measuring rate applies to both channels for the IFC2422 and IFC2466.

➡ Select the required measuring rate.

The measuring rate can be continuously adjusted from 0.1 kHz to 6.5 kHz respectively 30 kHz (IFC2465/2466) in increments of 100 Hz.

Monitoring the video signal helps to select a measuring rate, see 5.8.

Step-by-Step procedures:

➡ Place the target in the midrange, see Fig. 38. Keep adjusting the measuring rate until you get a high signal intensity that is not oversaturated.

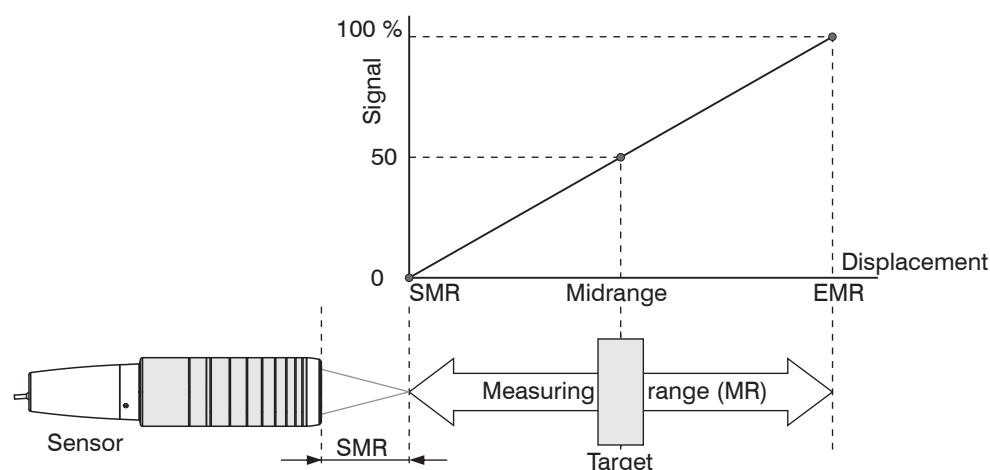

Fig. 38 Defining measuring range and output signal

➡ To do this, observe the `Intensity LED`.

LED	State	Description
Intensity 1/2	Red	Signal in saturation
	Yellow	Signal too low
	Green	Signal ok

- If the `Intensity LED` changes to red, increase the measuring rate.
- If the `Intensity LED` changes to yellow, reduce the measuring rate.

➡ Choose a measuring rate that makes the `Intensity LED` light up green.

➡ If necessary, change the exposure mode, use the `manual mode`, see 6.2.6.

➡ Use the required measuring rate, and adjust the exposure time. Or let the exposure time define possible measuring rates.

If the signal is low (`Intensity LED` is orange) or saturated (`Intensity LED` is red), the controller will carry out measurements, but measuring accuracy might not correspond to the specified technical data.

6.2.2 Reset Counter

The measured value counter can be used to check if the data are output completely or if a package is missing. Counting begins at zero.

6.2.3 Input Triggering

6.2.3.1 General

The trigger conditions applies to both channels for the IFC2422 and IFC2466.

The value input (data recording) on the confocalDT 2421/2422/2465/2466 can be controlled through an external electrical trigger signal or commands.

- Triggering does not affect preset measuring rates.
- Sync/Trig or TrigIn are used as external trigger input, see 4.4.10.
- Factory settings: no triggering, the controller starts transmitting data as soon as it is switched on.
- “Sync in” pulse duration is 5 μ s or more.

Sync/Trig	Trigger type	Level	Trigger-Level	Low / High	
		Edge	Trigger-Level	Falling edge / increasing edge	
			Number of measured values	manual selection	Value
	Terminating resistor (for IFC246x, see 6.1.3)		Off / on		
TrigIn	Trigger type	Level	Trigger-Level	Low / High	
		Edge	Trigger-Level	Falling edge / increasing edge	
			Number of measured values	manual selection	Value
	Input pulse		TTL / HTL		
Software		Number of measured values		manual selection	Value
				infinite	
Encoder 1/2		Lower limit			Value
		Upper limit			Value
		Step size			Value
Inactive		continuous measured value output			

Level triggering. Continuous value input for as long as the selected level is active. After that the controller stops the input/output of the values. Pulse duration must last for at least one cycle. The subsequent pause must also last for at least one cycle.

W = Displacement signal

Fig. 39 Active high level trigger (U_i), relevant analog signal (A_o) and digital signal (D_o)

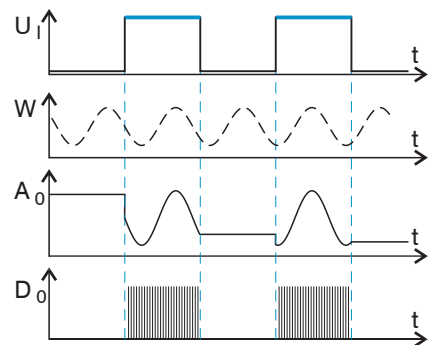

Edge triggering. Starts value input/output as soon as the selected edge is active to the trigger input. The duration of the pulse must be at least 5 μ s.

Fig. 40 Falling edge trigger (U_i), relevant analog signal (A_o) and digital signal (D_o)

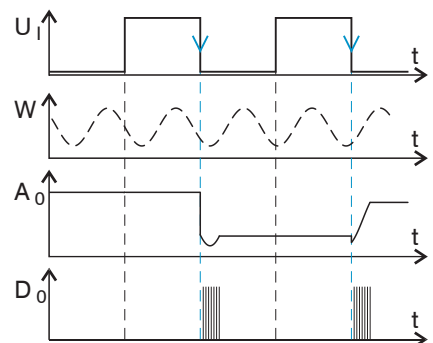

Software triggering. Starts measurement data recording as soon as a software command (instead of the trigger input) or the Initiate trigger button is activated.

Encoder triggering. Starts the measurement data recording through one of the both encoder inputs.

6.2.3.2 Triggering Data Recording

The current array signal is only further processed after a valid trigger event and the measured values are calculated from this. The measurement data is then transferred for further calculation (e.g. averaging or statistics), as well as the output via a digital or analog interface.

When calculating averages, measured values immediately before the trigger event cannot be included; instead older measured values are used, which had been entered during previous trigger events.

6.2.3.3 Trigger Time Difference

Since the exposure time is not started directly by the trigger input, the respective time difference to the measurement cycle can be output. This measured value can, for example serve to accurately assign measurements to one place, when measuring objects are scanned at a constant speed and when each track starts with a trigger.

The time from the start of the cycle until the trigger event is defined as a trigger time difference. The output of the time determined occurs 3 cycles later, due to the internal processing.

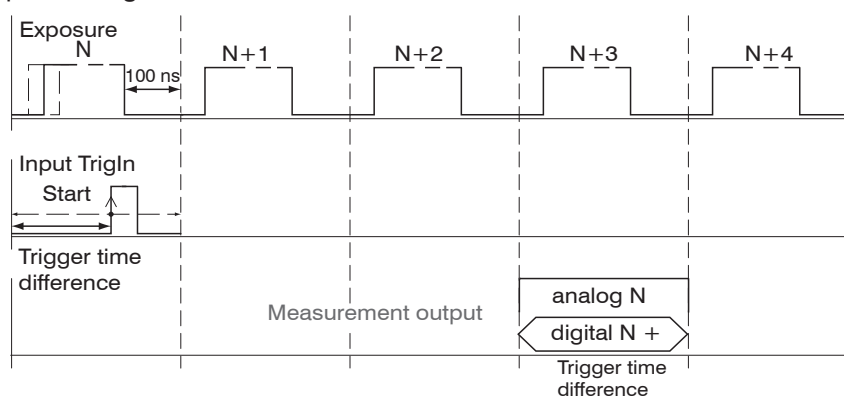

Fig. 41 Definition of the trigger time difference

- The start of the cycle does not mean the start of the exposure time. There is only a fixed difference of 100 ns between the start of the cycle and the end of the exposure time.

6.2.4 Masking the Evaluation Range

With the IFC2422/IFC2466, the user can set an individual evaluation range for both channels.

Masking limits the range that the video signal uses for distance or thickness calculations. This feature is used, for example, if ambient light with certain wavelengths (blue, red, IR) causes video signal interference. It is also possible to mask the background if it reaches into the measuring range.

Masking (start and end) is entered into the two boxes on the left (in %). The factory settings are 0 % (start) and 100 % (end).

i If you limit the video signal area, a peak is detected only, if it lies completely within the masked area, i. e. above the threshold. The measuring range can be reduced thereby.

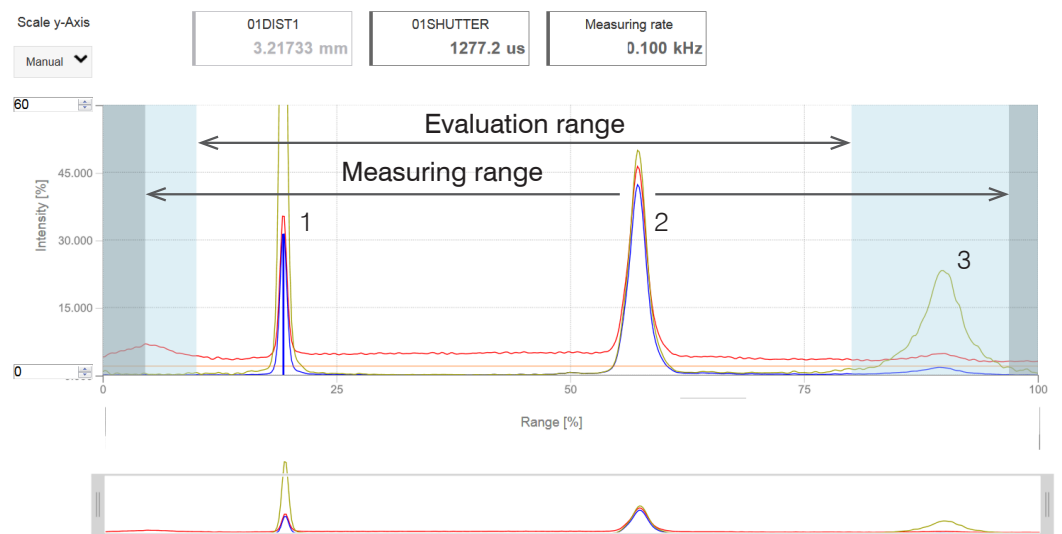

Fig. 42 Limiting the used video signal

The example shown in the figure uses the peaks (1) and (2) for the evaluation while peak (3) is not used.

6.2.5 Peak Symmetry

The peak symmetry value describes the deviation of the peak from the unlinearized center of gravity. It can be used as an indication as to whether the measured value is valid, e.g. on edges or fibers.

The output of the parameters 01SYMM and 02SYMM can be activated in the Measurement chart menu:

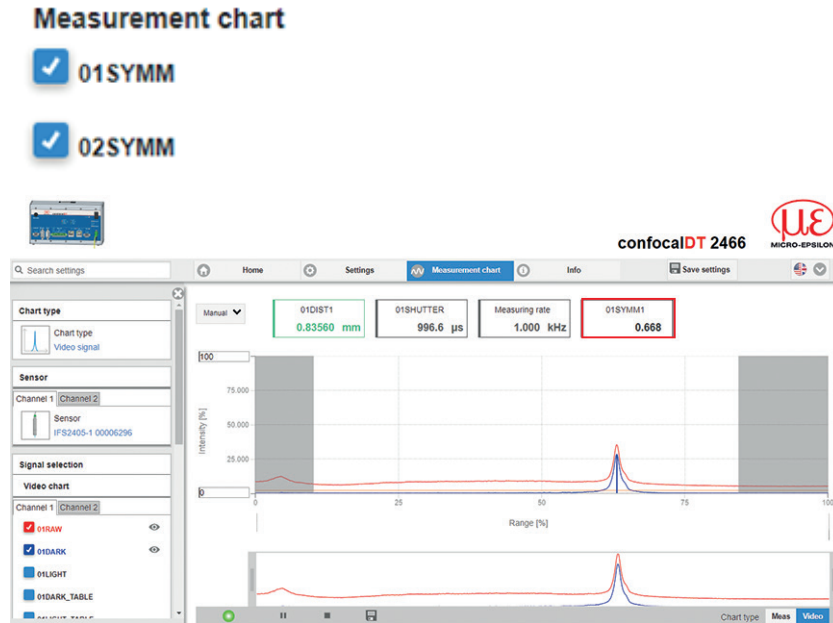
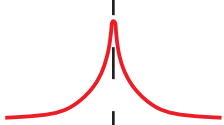
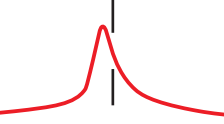
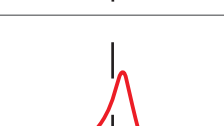

Fig. 43 Video signal in web interface with parameter 01SYMM

Appearance of peak in video signal	Description
	The peak is symmetrical: Parameter value approaches zero
	Center of gravity of peak shifted to the left: Parameter value is negative
	Center of gravity of peak shifted to the right: Parameter value is positive

Interface:	
EtherCAT / Ethernet	Data type: 32-bit fixed-point number (signed integer); 18-bit decimal places
	Value range: -8191 to +8191 (typically -5 to +5)
RS422	Data type: 18-bit fixed-point number (signed integer); 4-bit decimal places
	Value range: -8191 to +8191 (typically -5 to +5)

Fig. 44 Value ranges for peak symmetry

6.2.6 Exposure Mode

With the IFC2422 and IFC2466, the shutter mode can be individually set for both channels.

<i>Measurement mode</i>		
<i>Manuel mode</i>	Exposure time 1 in μs	IFC242x: Value (0.1 μs ... 10,000 μs) IFC246x: Value (3 μs ... 10.000 μs)
<i>Alternating two-time mode</i>	Exposure time 1 in μs	IFC242x: Value (0.1 μs ... 10,000 μs) IFC246x: Value (3 μs ... 10.000 μs)
	Exposure time 2 (shorter) in μs	Value (value is shorter than time 1)
<i>Automatic two-time mode</i>	Exposure time 1 in μs	IFC242x: Value (0.1 μs ... 10,000 μs) IFC246x: Value (3 μs ... 10.000 μs)
	Exposure time 2 (shorter) in μs	Value (value is shorter than time 1)

➡ Select the required exposure mode.

Measurement mode. Maintains the required or suitable measuring rate, and adjusts only the exposure time. A smaller control range is used to achieve faster results. This mode also enables the user to work with targets with different reflections that have the same measuring rates. Lasts 1 up to a maximum of 7 measurement cycles (change from no target too good reflective target with 0.1 kHz measuring rate).

Manuel mode. No automatic adjustments. Set (optimized) values are maintained. This makes sense for fast changes due to targets with identical surfaces moving in and out or for highly dynamic movements (no overshoots). It is not recommended to use this mode for strongly varying target surfaces. Manual mode can also be used for several layers if the brightest peak should not be captured. The video signal display can acquire suitable measuring rates and exposure times from automatic mode.

Alternating two-time mode. Operating mode with two manually preset exposure times that are used alternately. Suitable for two very different high peaks when measuring thickness. We recommend using this mode in particular, if the smaller peak disappears or the higher peak overshoots. A possibly set video averaging is ignored here.

Automatic two-time mode. Fastest mode with two manually preset exposure times. The more suitable time is automatically selected. We recommend using this mode to measure distances for fast changing surface properties, such as mirrored or anti-glare glass.

 Gray shaded fields require a selection.

 *Value* Dark-bordered fields require you to specify a value.

6.2.7 Peak Separation

6.2.7.1 Detection Threshold

With the IFC2422/IFC2466, the detection threshold can be set individually for both channels.

The detection threshold (in %, relates to the signal after dark correction) defines the minimum intensity for including a video signal peak in the measurement. Therefore, the video graph must be taken into consideration when defining the threshold.

Min threshold	Value	Value in %, default 2 %
---------------	-------	-------------------------

Defining the detection threshold

- For very weak signals (e.g. typical for extremely high measuring rates), choose a low detection threshold, as only signal parts above this threshold will be included in measurements.
- In general, set the threshold high enough to avoid that any interfering video signal peaks are detected.

The detection threshold affects linearity, it is therefore recommended to adjust it as little as possible.

6.2.7.2 Peak Modulation

With the IFC2422/IFC2466, the peak modulation can be set individually for both channels. Peak modulation is used e.g. when measuring thin layers.

A peak detected with the detection threshold may consist of two or more overlapping peaks. The peak modulation indicates to which degree the video signal must be modulated in order to separate the peak again for the subsequent signal processing.

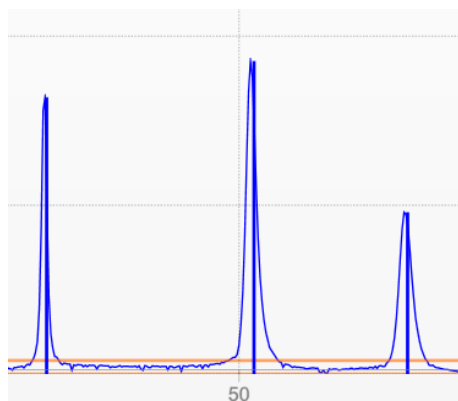

Fig. 45 Separated peaks: measurement possible

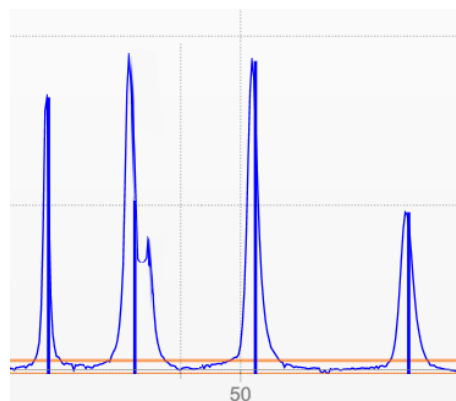

Fig. 46 Interleaved peaks: probable measurement uncertainty

The modulation is individually evaluated for each peak detected with the detection threshold.

Default value is 50 % as a compromise between the separability of the peaks and the measurement uncertainty due to mutual peak interference.

- Increase the value when the controller separates peaks which should be processed together.
- Decrease the value when the controller does not separate peaks which should be processed separately.

Example 1: With the default setting, no peak separation is carried out. The controller determines a distance from the center of gravity in the video signal.

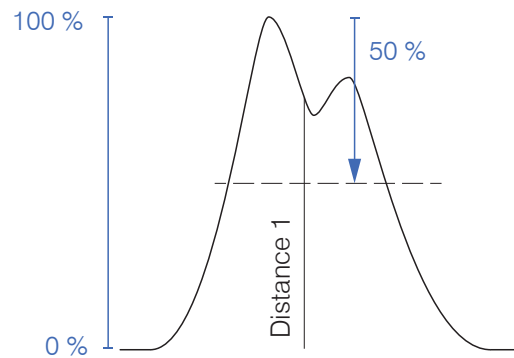

Example 2: With a lower peak modulation value, the controller detects two separate peaks in the video signal and calculates two distances.

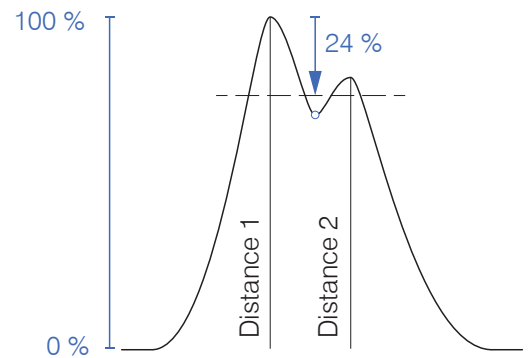

Fig. 47 Examples for peak modulation

Changing the `peak modulation` is only necessary in special cases. Use this function carefully.

6.2.8 Peak Selection, Number of Measurement Values

With the IFC2422/IFC2466, the number of peaks can be set individually for both channels. Each channel detects up to six peaks.

i This function is used, if a material generates peaks in front of or between the applied peaks caused by thin layers on the measurement object. This function should be used with care and exclusively by product specialists.

The selection of the peaks determines which areas in the signal are used for the distance or thickness measurement. If a measurement object contains multiple transparent layers, a correct measurement result is determined only for the first peak (distance measurement) and the first two peaks (thickness measurement).

The peaks are counted from the start of measuring range to the end of measuring range.

1 measurement value	first peak / highest peak / last peak
2 measurement values	first and second peak / highest and second highest peak / second to last and last peak
3 measurement values	Individual
4 measurement values	Individual
5 measurement values	Individual
6 measurement values	Individual

Fig. 48 Options for peak selection

The determination of the peak heights is performed using the light corrected signal.

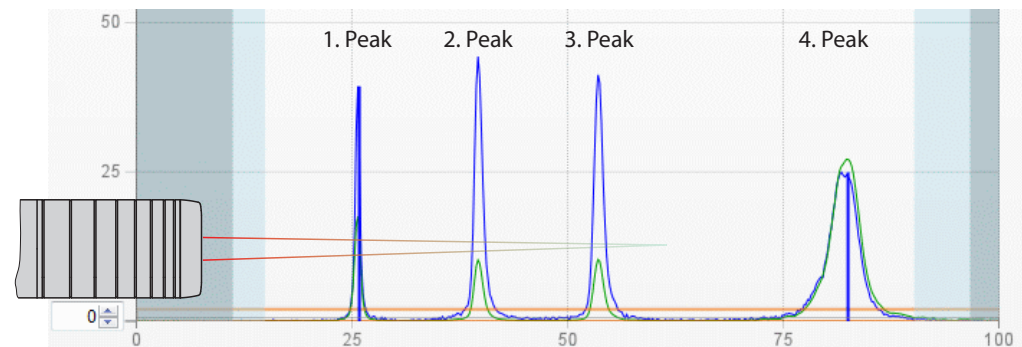
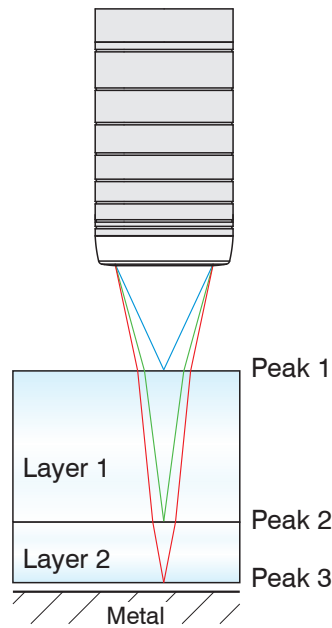

Fig. 49 Extract of a video signal with four peaks in the measuring range

By default the refractive correction is performed. If more than two peaks are within the measuring range, an exact refractive correction is performed with the same amount of peaks only. Example: 3 peaks, the first or the last peak leaves the measuring range sometimes. Switch off the refractive correction, because the refractive correction is applied on a different layer, a clear assignment of the material is not possible.

6.2.9 Material Selection

With the IFC2422/IFC2466, the target material can be set individually for both channels.



Displacement and thickness measurements require the refractive correction in the controller.

- ➡ Change to the `Material selection` menu.
- ➡ Activate the refractive correction. Click on the button `On` in the on/off refractive correction menu.
- ➡ Select the used material of each layer.

Fig. 50 Target layers

Clicking on the button `Edit material table` expands/reduces the materials database in the controller. For a new material, a refractive index and the Abbe number v_d are required or three refractive index numbers for different wavelengths (also approx. the same).

Vacuum	vacuum, air (approximately)	1
Water	(a liquid)	1.337121
Ethanol	ethyl alcohol, pure alcohol (a liquid)	1.3614
Acrylic	acrylic resin, adhesive, lacquer	1.497828
PMMA	polymethyl methacrylate, acrylic glass (a plastic)	1.497761
PMMI	polymethacrylmethylimide, polymethyl methacrylimide (a plastic)	1.534
	polystyrene, polystyrol (a plastic)	

On/off refractive correction:
On is the default setting if the expected n_r recommended to disable the refractive correction always 1.0).

Fig. 51 Material-specific refractive index numbers

6.3 Signal Processing

6.3.1 Spike Correction

With the IFC2422/IFC2466, the spike correction can be set individually for both channels. This special form of filtering is used to remove very high spikes from a relatively constant course of measurement values, though while retaining any smaller spikes. A median would remove all the spikes.

The assessment of whether a measurement is a spike (outlier) is based on the mean of a particular number of previous valid readings. The permissible deviation from the next value is calculated using the tolerance range. If the new measured value deviates too much, it will be corrected to the previous value. A maximum number of consecutive measured values to be corrected must also be stated.

This function acts the same way on all output distances; the differences (thicknesses) are calculated on the basis of the corrected distances.

Spike correction - Channel 1

Spike correction:
 Off On

Evaluation length

Tolerance range in mm

Number of corrected values

Attention: In the event of several consecutive spikes (outliers), the previous corrected value is used in the correction of the following measured value. Use this function only in appropriate applications. Improper use can lead to a distortion of the measured value sequence! Check the possible impact of a changed measured value sequence on the measuring environment and subsequent controllers/systems.

- Evaluation length (max. 10): x
- Max. Tolerance range (mm); the spike (outlier) correction comes into play when the value is not met or is exceeded: y
- Number of corrected values (max. 100): z

Example: x = 3 / y = 0.05 / z = 1

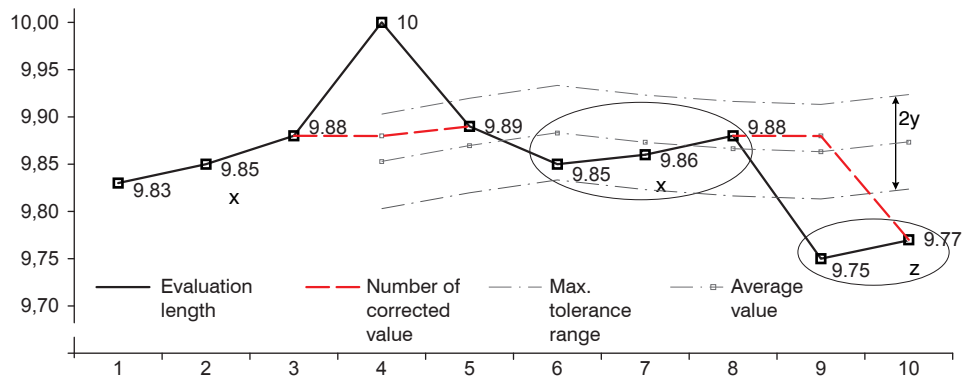

Fig. 52 Correction of measuring values

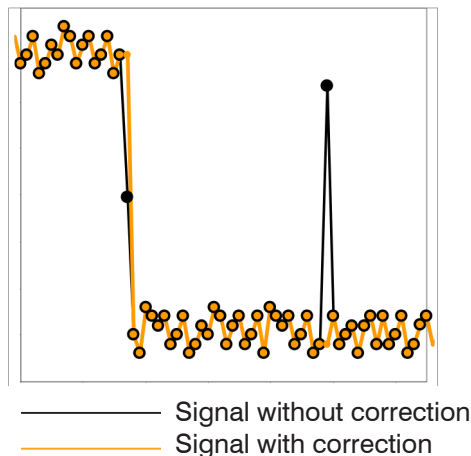

Fig. 53 Different signals

Application tips

- Eliminating spikes with an adjustable threshold
- For highly dynamic data acquisition of fast moving objects
- With measurement jumps suitable, especially those with interfering peaks
- With edge jumps and with some bent edge transitions
- Execution is done before other averages take place

6.3.2 Calculation

6.3.2.1 Data Source, Parameter, Programs

With the IFC2422/2466, calculation can be set individually for both channels.

One calculation operation can be performed in each calculation block. The calculation program, the data sources and the parameters of the calculation program must be set for this.

Thickness	Difference	Two signals or results, Signal Distance B < Signal Distance A
Formula		Distance A - Distance B
Calculation	Summation	Two signals or results
Formula		Factor 1 * Distance A + Factor 2 * Distance B + Offset
Median		
Moving Average		
Recursive Average		

Fig. 54 Available programs

Sequence for creating a calculation block, see Fig. 55:

- ➡ Select a program ①, e.g. average
- ➡ Define the parameter ②.
- ➡ Define the data source(s) ③.
- ➡ Enter a block name ④.
- ➡ Click on the button Store calculation.

Fig. 55 Sequence for the program selection

The programs calculation and thickness have two data sources. Averaging programs each have one data source.

Calculation parameters (Calculation)	Factor 1 / 2	Value	-32768.0 ... 32767.0
	Offset	Value	-2147.0 ... 2147.0
Calculation parameters (Averaging)	Average type	Recursive / Moving / Median	
	Number of values	Value	Recursive: 2 ... 32000
		Value	Moving: 2 / 4 / 8 / 16 / 32 / 64 / 128 / 256 / 512 / 1024 / 2048 / 4096
		Value	Median: 3 / 5 / 7 / 9

The number of values states over how many sequential measured values in the controller should be averaged before a new measured value is output.

 Gray shaded fields require a selection.

 Dark-bordered fields require you to specify a value.

6.3.2.2 Definitions

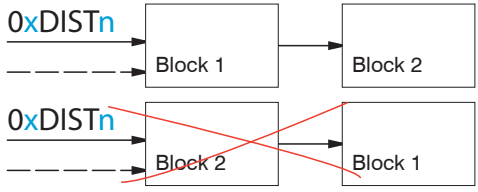
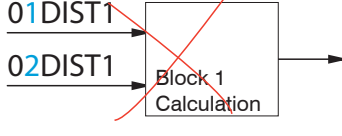
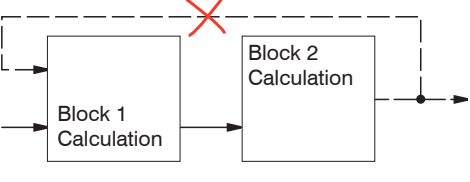
<p>Distance value(s) of channel/Sensor 1</p>	<p>01DIST1, 01DIST2, ... 01DIST6</p>
<p>Distance value(s) of channel/Sensor 2</p>	<p>02DIST1, 02DIST2, ... 02DIST6</p>
<p>Max. 10 calculation blocks per channel/sensor. The calculation blocks are processed sequentially.</p>	
<p>The calculation blocks in the <i>Signal processing</i> menu process only distances and calculated results of the respective channel/sensor.</p>	
<p>Feedback couplings (algebraic loops) over one or several blocks are not possible. Only the distance values or the calculated results from the previous calculation blocks can be used as data source.</p>	
<p>Processing sequence</p> <ol style="list-style-type: none"> 1. Unlinearized distances 2. Linearization of distances 3. Refractive correction of distances 4. Error handling in the case of no valid measured value 5. Spike correction of distances 6. Calculation blocks 7. Statistics 	

6.3.2.3 Measurement Averaging

Measurement averaging is performed after measurement values have been calculated, and before they are issued or processed through the relevant interfaces.

Measurement averaging

- improves the resolution
- allows masking individual interference points, and
- ‘smoothes’ the reading.

i Linearity is not affected by averaging. Averaging has no effect on measuring rate and output rate.

The internal average value is re-calculated for each measuring cycle.

i The defined type of average value and the number of values must be stored in the controller to ensure they are hold after it is switched off.

Controller IFC242x is delivered with “moving average, averaging value = 16” as factory settings, i.e. averaging is not enabled by default.

Moving average

The definable number N for successive measurements (window width) is used to calculate the arithmetic average M_{mov} according to the following formula:

$$M_{mov} = \frac{\sum_{k=1}^N MV(k)}{N}$$

MV = measured value
 N = averaging value
 k = continuous index (in the window)
 M_{mov} = average value or output value

Each new measured value is added, and the first (oldest) value is removed from the averaging (from the window). This produces short response times for measurement jumps.

Example: N = 4

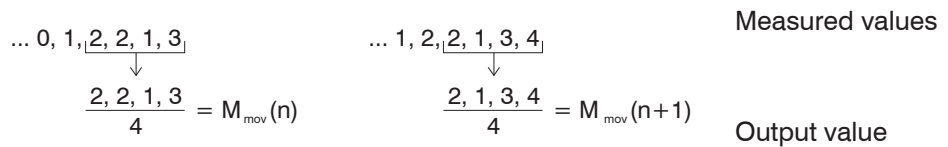

i Moving average in the controller IFC242x allows only potentials of 2 for N. The highest averaging value is 1024.

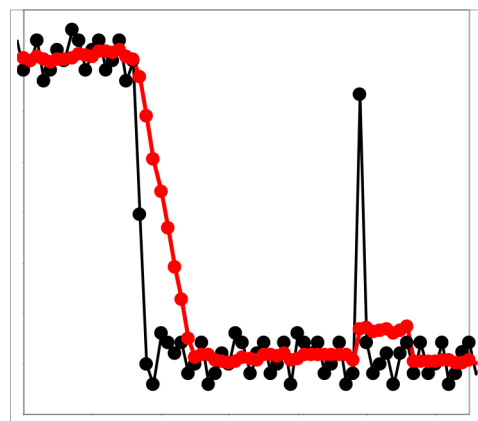

— Signal without averaging
 — Signal with averaging

Fig. 56 Moving average, N = 8

Application tips

- Smooths measured values
- The effect can be finely controlled in comparison with the recursive averaging
- With uniform noise of the measured values without spikes
- At a slightly rough surface, in which the roughness should be eliminated
- Also suitable for measured value jumps at relatively low settling time

Recursive Average

Formula:

$$M_{rec}(n) = \frac{MV_{(n)} + (N-1) \times M_{rec(n-1)}}{N}$$

MV = measured value

N = averaging value, N = 1 ... 32768

n = measurement index

M_{rec} = average value or output value

The weighted value of each new measured value MV(n) is added to the sum of the previous average values

M_{rec}(n-1).

Recursive averaging allows for very strong smoothing of the measurements, however it requires long response times for measurement jumps. The recursive average value shows low-pass behavior.

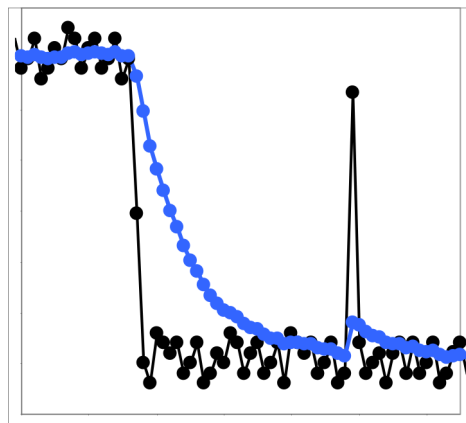

————— Signal without averaging
 ———— Signal with averaging

Fig. 57 Recursive average, N = 8

Application tips

- Permits a high degree of smoothing of the measurement values. However, it requires extremely long transient recovery times for measured value jumps (low-pass behavior)
- Permits a high degree of smoothing for noise without strong spikes
- For static measurements, to smooth signal noise
- For dynamic measurements on rough surfaces, to eliminate the roughness, e.g. roughness of paper
- For the elimination of structures, e. g. parts with uniform grooves, knurled rotary parts or roughly milled parts
- Unsuitable for highly dynamic measurements

Median

A median value is formed from a preselected number of measurements.

When creating a median value for the controller, incoming readings are sorted after each measurement. Then, the average value is provided as the median value.

3, 5, 7 or 9 readings are taken into account. This means that individual interference pulses can be suppressed. However, smoothing of the measurement curves is not very strong.

Example: Median value from five readings

... 0 1 2 4 5 1 3 → Messwerte sortiert: 1 2 **3** 4 5 Median_(n) = 3
 ... 1 2 4 5 1 3 5 → Messwerte sortiert: 1 3 **4** 5 5 Median_(n+1) = 4

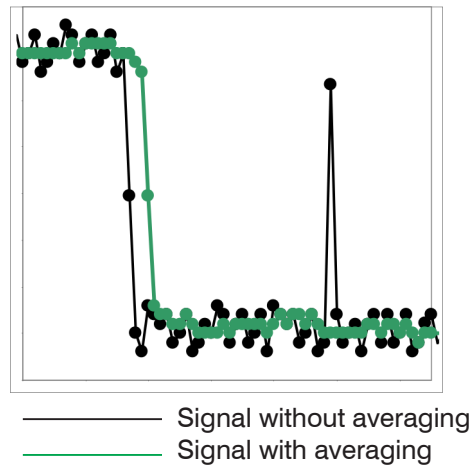

Fig. 58 Median, N = 7

Application tips

- The measurement value curve is not smoothed to a great extent, used to eliminate spikes
- Suppresses individual interference pulses
- In short, strong signal peaks (spikes)
- Also suitable for edge jumps (only minor influence)
- For rough, dusty or dirty environment, to eliminate dirt or roughness
- Further averaging can be used after the median filter

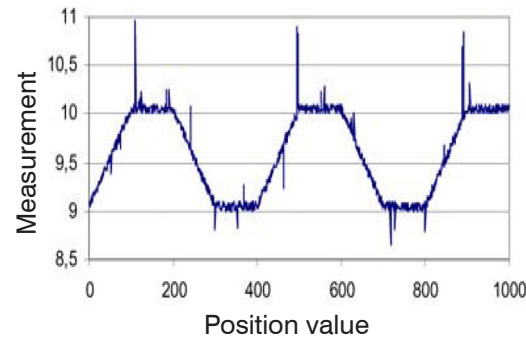

Fig. 59 Original profile

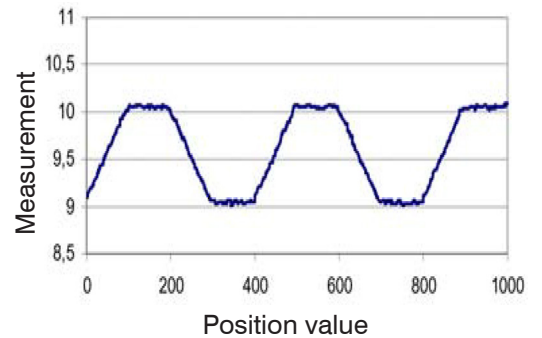

Fig. 60 Profile with Median, N = 9

6.4 Postprocessing

6.4.1 Calculation

6.4.1.1 Data Source, Parameter, Programs

In each calculation block one calculation step can be carried out. To do so, you must adjust the calculation program, the data sources and the program parameters.

Thickness	Difference	Two signals or results, Signal Distance B < Signal Distance A
Formula		Distance A - Distance B
Calculation	Summation	Two signals or results
Formula		Factor 1 * Distance A + Factor 2 * Distance B + Offset
Median		
Moving Average		
Recursive Average		

Fig. 61 Available programs

Sequence for creating a calculation block, see Fig. 62:

➡ Select a program ①, e.g. average

➡ Define the parameter ②.

➡ Define the data source(s) ③.

➡ Enter a block name ④.

➡ Click on the button
Store calculation.

Fig. 62 Sequence for the program selection

The programs calculation and thickness have two data sources. Averaging programs have respectively one data source.

Calculation parameters (Calculation)	Factor 1 / 2	Value	-32768.0 ... 32767.0
	Offset	Value	-2147.0 ... 2147.0
Calculation parameters (Averaging)	Average type	Recursive / Moving / Median	
	Number of values	Value	Recursive: 2 ... 32000
		Value	Moving: 2 / 4 / 8 / 16 / 32 / 64 / 128 / 256 / 512 / 1024 / 2048 / 4096
		Value	Median: 3 / 5 / 7 / 9

The number of values indicates how many consecutive values are averaged in the controller before a new measurement value is output.

Gray shaded fields require a selection.

Value Dark-bordered fields require you to specify a value.

6.4.1.2 Definitions

Distance value(s) of channel/Sensor 1	01DIST1, 01DIST2, ... 01DIST6
Distance value(s) of channel/Sensor 2	02DIST1, 02DIST2, ... 02DIST6
A maximum of 10 calculation blocks is possible. The calculation blocks are processed sequentially.	
Feedback couplings (algebraic loops) over one or several blocks are not possible. Only the distance values or the calculated results from the previous calculation blocks can be used as data source.	
<p>Processing sequence</p> <ol style="list-style-type: none"> 1. Unlinearized distances 2. Linearization of distances 3. Refractive correction of distances 4. Error handling in the case of no valid measured value 5. Spike correction of distances 6. Calculation blocks signal processing 7. Calculation blocks post processing 8. Zeroing, Mastering 9. Data reduction 10. Data output 	

6.4.1.3 Measurement Averaging

The measurement averaging corresponds to the averaging in the signal processing menu, [see 6.3.2.3](#).

Averaging is possible in two different areas:

- Signal Processing
- Postprocessing

Averaging is recommended for static measurements or slowly changing measured values. Averaging reduces noise or suppresses spikes in the measurement values.

6.4.2 Zeroing, Mastering

Use zeroing and setting masters to define a target value within the measuring range. This shifts the output range. This feature can be useful, for example, when several sensors carry out measurements simultaneously in thickness and planeness measurements. When measuring the thickness of a transparent target, you need to specify the actual thickness of a master object as `Master value`.

Master value in mm	Value	Specify the thickness (or other parameter) of a master object. Value range: - 2147.0 ... +2147.0 mm
--------------------	-------	--

Mastering (setting masters) is used to compensate for mechanical tolerances in the sensor measurement setup or to correct chronological (thermal) changes to the measuring system. The master value, also called calibration value, is defined as the target value.

The `master value` is the reading that is issued as result of measuring a master object. Zeroing is when you set a master with 0 (zero) as the master value.

Position	Signal	Value
1	01DIST1	3.000
2		
3		
4		
5		
6		
7		
8		
9		
10		

The zeroing/mastering function is not channel-specific. The controller manages up to 10 master signals. These 10 signals can be applied to any internally determined value. This also applies for calculated values.

i Mastering or zeroing requires a target object to be present in the measuring range and affects both analog and digital outputs.

- 1 Starts/stops the function
- 2 Applies a certain selected signal or function to all defined signals (5)
- 3 Deletes a signal
- 4 Selects a signal for the function, assigns master value
- 5 Overview of all existing signals for the function

Fig. 63 Mastering dialog, overview of individual master values

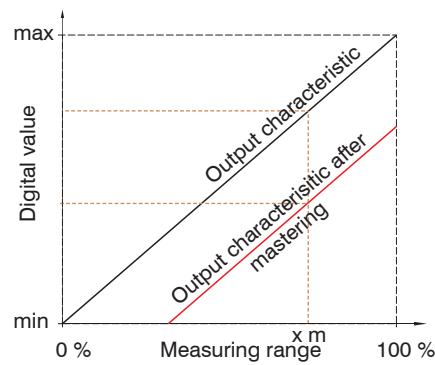

When setting a master, the output characteristic is moved in parallel. Moving the characteristic reduces the relevant measuring range of a sensor (the further master value and master position are located, the greater the reduction).

Setting masters/Zeroing – Step-by-Step:

- Place target and sensor into their required positions.
- Define the `Master value` (web interface/ASCII).

After setting the master, the controller will issue new readings that relate to the master value. If you click the `Reset master value` button to undo the mastering process, the system reverts to the state that existed before the master was set.

Fig. 64 Moving the characteristic when mastering



Fig. 65 Flow chart for zeroing, mastering (key Multifunction)

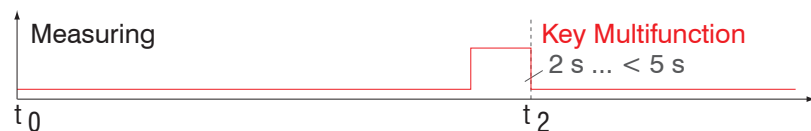

Fig. 66 Flow chart for resetting zeroing/mastering

The zeroing/mastering function can be applied several times in a row.

6.4.3 Statistics

The controller derives the following statistical values from the measurement result:

Statistical values are calculated from measured values within the evaluation range. The evaluation range is updated with every new measurement value.

Statistical values are displayed in the web interface, the `measurement chart` or are output via the interfaces.

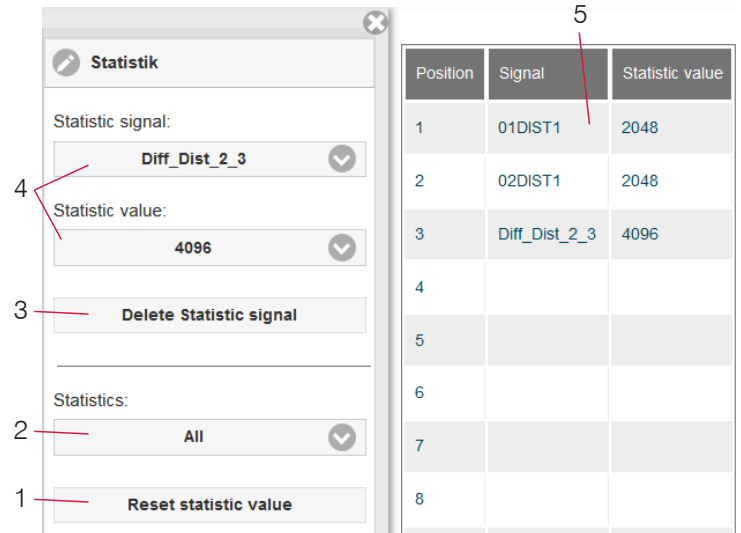

The statistical values are not channel-specific. The controller manages up to 10 statistical values. These 10 signals can be applied to any internally determined value. This also applies for calculated values.

Fig. 67 Overview of the individual statistical values

- 1 Use the `Reset statistic value` button to reset a certain signal or all statistic signals in order to start a new evaluation cycle (storage period). When a new cycle starts, previous statistical values are deleted.
- 2 Deletes a signal.
- 3 Number of measurement values based on which minimum, maximum and peak-to-peak are determined for a signal. The range of values used for calculation can be between 2 and 16384 (in powers of 2) or include all measured values.
- 4 Selects a signal for the function.
- 5 Overview of all existing signals for the function.

Sequence for creating a statistical evaluation:

- ➡ Change to the tab `Settings > Postprocessing > Statistics`.
- ➡ Choose a signal (4) for which the statistical values should be calculated.
- ➡ Define the evaluation range via the `statistic value`.

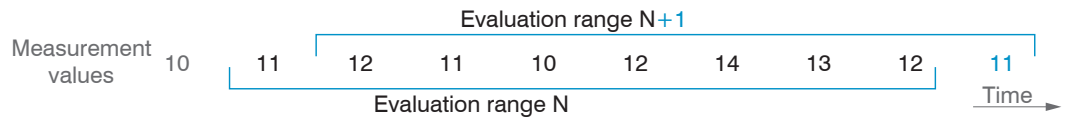

Fig. 68 Dynamic update of evaluation range via measurement values, statistical value = 8

6.4.4 Output Triggering

6.4.4.1 General

The value output (data output) on the confocalDT 2421/2422/2465/2466 can be controlled through an external electrical trigger signal or commands. Both analog and digital outputs are affected. The measured value to the trigger point is output delayed.

- Triggering does not affect preset measuring rates.
- Sync/Trig or TrigIn are used as external trigger input, see 4.4.10.
- Factory settings: no triggering, the controller starts transmitting data as soon as it is switched on.
- “Sync in” pulse duration is 5 μ s or more.

Sync/Trig	Trigger type	Level	Trigger level	Low / High	
		Edge	Trigger level	Falling edge / increasing edge	
	Number of measured values		manual selection		Value
Terminating resistor (for IFC246x, see 6.1.3)		Off / on			
TrigIn	Trigger type	Level	Trigger level	Low / High	
		Edge	Trigger level	Falling edge / increasing edge	
	Number of measured values		manual selection		Value
Input pulse		TTL / HTL			
Software		Number of measured values		manual selection	
				infinite	
Encoder 1/2		Lower limit			Value
		Upper limit			Value
		Step size			Value
Inactive		continuous measured value output			

Level triggering. Continuous value output for as long as the selected level is active. After that the controller stops the output of the values. Pulse duration must last for at least one cycle. The subsequent pause must also last for at least one cycle.

W = displacement signal

Fig. 69 Active high level trigger (U_i), relevant analog signal (A_0) and digital signal (D_0)

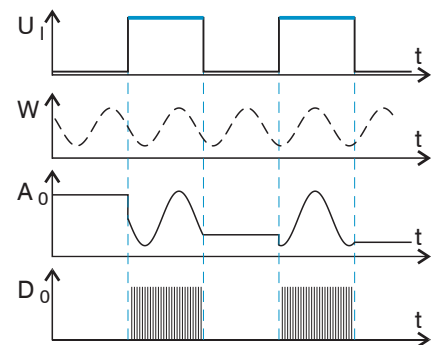

Edge triggering. Starts value output as soon as the selected edge is active to the trigger input. If trigger conditions are met, the controller outputs a defined number of measurements. Value range between 1 and 16383. After completion of data output the analog output remains standing at the last value (Sample & Hold).

The duration of the pulse must be at least 5 μ s.

Fig. 70 Falling edge trigger (U_i), relevant analog signal (A_0) and digital signal (D_0)

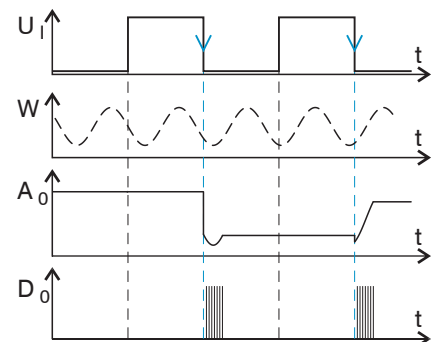

Software triggering. Starts measurement data output as soon as a software command (instead of the trigger input) or the Initiate trigger button is activated.

Encoder triggering. Starts the measurement data output through one of the both encoder inputs.

6.4.4.2 Triggering Data Output

Measurement values are calculated continuously and independently of the trigger event. A trigger event simply triggers the value output via a digital or an analog interface.

Therefore, any values measured immediately before the trigger event are included in calculating mean values (averages) or statistics.

The triggering of the measured value recording and output have the same timing.

6.4.5 Data Reduction, Output Data Rate

Data reduction	Value	<i>Instructs the controller, which data are excluded from the output, and thus the amount of transmitted data is reduced.</i>
Reduction applies for	RS422 / Analog / Ethernet	<i>The interfaces, which are provided for the sub-sampling, are to be selected with the checkbox.</i>

You can reduce the measurement output in the sensor if you set the output of every nth measurement value in the web interface or by command. Data reductions causes only every nth measured value to be output. The other measurement values are rejected. The reduction value n can range from 1 (each measurement value) to 3,000,000. This allows you to adjust slower processes, such as a PLC, to the fast sensor without having to reduce the measuring rate.

6.4.6 Error Handling (Hold Last Value)

If no valid reading can be obtained, an error is issued. Should this be a problem for processing, the last valid value can be hold for a certain period of time, and will be issued repeatedly.

Error handling	Error output, no value	<i>Instead of a value, interfaces output an error</i>	
	Hold last value infinitely	<i>Interfaces output the last valid value until a new, valid value is available</i>	
	Hold last value	Value	<i>Possible number of values to be maintained between 1 and 1024 When number = 0, the last value is maintained until a new, valid value is displayed</i>

 Gray shaded fields require a selection.

 Dark-bordered fields require you to specify a value.

6.5 Outputs

6.5.1 Digital Interfaces

Digital interface selection	RS422 / Ethernet / Error output (switching outputs)	Defines which interface is used for data output. A parallel data output via multiple channels is possible.	
RS422	Baud rate	9.6 / 115.2 / 230.4 / 460.8 / 691.2 / 921.6 / 2000 / 3000 / 4000 kBps	
Ethernet	IP settings controller	Static / DHCP	Values for IP address / gateway / subnet mask. Only for static IP addresses.
	Ethernet measured value transmission	Server TCP	Value for the port

6.5.1.1 RS422

The RS422 interface has a maximum baud rate of 4000 kBaud. As a factory setting, the baud rate is set to 115.2 kBaud. Use ASCII commands or the web interface to configure.

Transfer settings for controller and PC must match.

Data format: Binary. Interface parameters: 8 data bits, no parity, 1 stop bit (8N1). Selectable baud rate.

The RS422 interface can transfer 18 bits per output value.

The maximum number of measured values that can be transferred for each measuring point depends on the controller measuring rate and the selected RS422 interface transmission rate. Where possible, use the maximum available transmission rate (baud rate), see [A 5.3.13](#).

6.5.1.2 Ethernet

When using a static IP address, you need to specify values for IP address, gateway and subnet mask. This is not necessary when using DHCP.

The controller is factory set to the static IP address 169.254.168.150

The controller transmits the Ethernet packets at a transmission rate of 10 MBit/s or 100 MBit/s. The transfer rate is selected automatically depending on the connected network or PC.

Any output values and additional information to be transmitted that are logged at one point in time are combined to form a value frame. Multiple value frames are combined as one measurement block. A header is added to the start of each measurement value packet.

When transmitting measurement data, the controller sends each measurement value (measured value block) to the connected remote station after successful connection establishment. No explicit request is required.

If any changes are made to the transmitted data or the frame rate, a new header will be sent automatically. Distance and thickness values are transmitted as 32 bit signed integer with 1 nm resolution.

This measured value block can also consist of several Ethernet packets depending on the size of the video signal.

6.5.1.3 Data Output RS422, Ethernet

The output data from all internally determined values and the calculated values from the calculation modules are selected separately for each of the two interfaces. This data is then output in a defined sequence. The selected values for Ethernet include the signals for the transfer of the measures values and the video data. However, this does not apply for the web diagram.

Fig. 71 Select output data

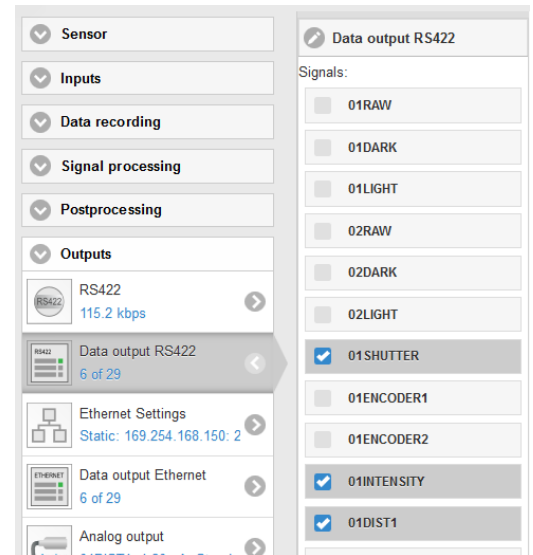

6.5.2 Analog Output

Only one type of measurement can be transmitted at any given time. The analog output has a resolution of 16 bit.

Output signal	01DIST1 / ... 01DIST6 / 02DIST1 / ... 02DIST6 / ...	The data selection depends on the current setting and includes, in addition to the distance values, also the results from the calculation modules.	
Output range	4 ... 20 mA / 0 ... 5 V / 0 ... 10 V	Either the voltage or the current output on the controller can be used.	
Scale	Standard scale	Scaled to 0 ... measuring range	
	Two-point scale	Minimum value (in mm):	Value
		Maximum value (in mm):	Value

The first value corresponds to the start of the measuring range and the second value to the end of the measuring range. If the analog range needs to be moved, we recommend to use zeroing or mastering.

Two-point scaling enables the user to specify separate start and end values (in mm) for the sensor's measuring range. The available output range of the analog output is then spread between the minimum and maximum values. This allows for decreasing analog characteristics, see Fig. 72.

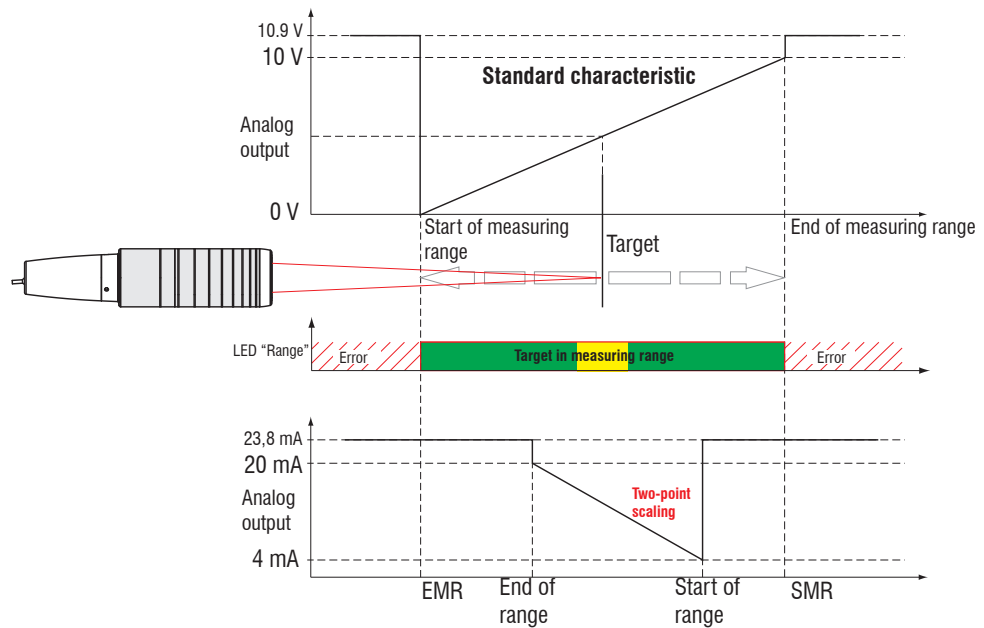

Fig. 72 Scaling the analog signal

Gray shaded fields require a selection.

Dark-bordered fields require you to specify a value.

6.5.2.1 Calculation of the Measurement Value at the Current Output

Current output (without mastering, without two-point scale)

Variables	Value range	Formula
I_{OUT} = current [mA]	[3.8; <4] SMR reserve [4; 20] measuring range [>20; 20.2] EMR reserve	$d [mm] = \frac{(I_{OUT} [mA] - 4)}{16} * MR [mm]$
MR = measuring range [mm]	{0.1/0.3/0.4/1/1.5/2/2.5/2/3/3.5/4/6/ 6.5/10/28/30}	
d = distance [mm]	[-0.01MR; 1.01MR]	

Current output (with two-point scale)

Variables	Value range	Formula
I_{OUT} = current [mA]	[3.8; <4] SMR reserve [4; 20] measuring range [>20; 20.2] EMR reserve	$d [mm] = \frac{(I_{OUT} [mA] - 4)}{16} * n [mm] - m [mm] $
MR = measuring range [mm]	{0.1/0.3/0.4/1/1.5/2/2.5/2/3/3.5/4/6/ 6.5/10/28/30}	
m, n = teaching area [mm]	[0; MR]	
d = distance [mm]	[m; n]	

6.5.2.2 Calculation of the Measurement Value at the Voltage Output

Voltage output (without mastering, without two-point scale)

Variables	Value range	Formula
U_{OUT} = voltage [V]	[-0.05; <0] SMR reserve [0; 5] measuring range [>5; 5.05] EMR reserve	$d [mm] = \frac{U_{OUT} [V]}{5} * MR [mm]$
	[-0.1; <0] SMR reserve [0; 10] measuring range [>10; 10.1] EMR reserve	$d [mm] = \frac{U_{OUT} [V]}{10} * MR [mm]$
MR = measuring range [mm]	{0.1/0.3/0.4/1/1.5/2/2.5/2/3/3.5/4/6/ 6.5/10/28/30}	
d = distance [mm]	[-0.01MR; 1.01MR]	

Voltage output (with two-point scale)

Variables	Value range	Formula
U_{OUT} = voltage [V]	[-0.05; <0] SMR reserve [0; 5] measuring range [>5; 5.05] EMR reserve	$d [mm] = \frac{U_{OUT} [V]}{5} * n [mm] - m [mm] $
	[-0.1; <0] SMR reserve [0; 10] measuring range [>10; 10.1] EMR reserve	$d [mm] = \frac{U_{OUT} [V]}{10} * n [mm] - m [mm] $
MR = measuring range [mm]	{0.1/0.3/0.4/1/1.5/2/2.5/2/3/3.5/4/6/ 6.5/10/28/30}	
m, n = teaching area [mm]	[0; MR]	
d = distance [mm]	[m; n]	

6.5.2.3 Characteristics Distance Value and Analog Output

The zero setting function set the analog output on half of the output range: current output 12 mA; voltage output 2.5 V or 5 V. The Master function (master value \neq zero) sets the analog output to the scaled value for the master value. The examples below show the current output and the distance value behavior of an IFS2404-2 with 2 mm measuring range.

Target at 16 % measuring range

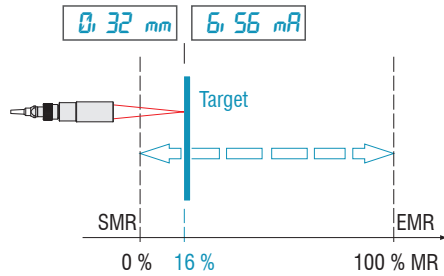

▶ Zero setting (MV = 0 mm)

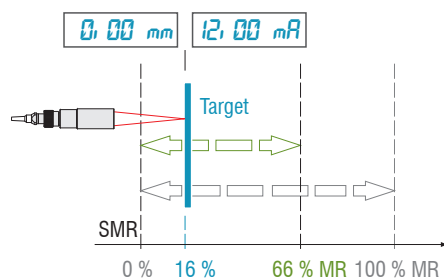

Analog maximum reached at 66 % MR

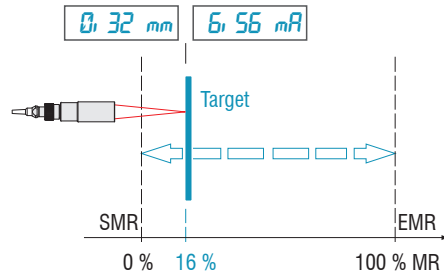

▶ Set master value 0.8 mm

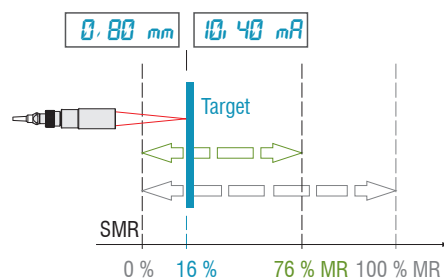

Analog maximum reached at 76 % MR

Target at 60 % measuring range

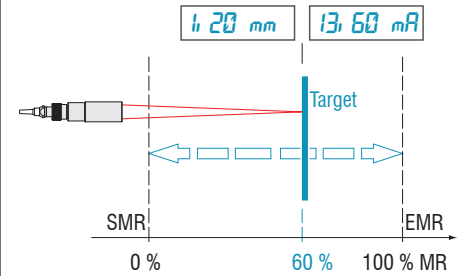

▶ Set master value 0.8 mm

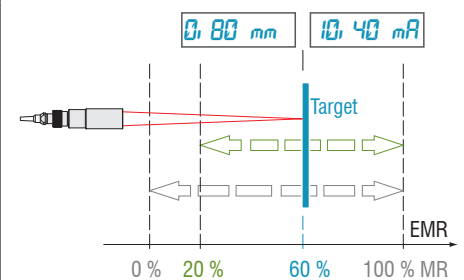

Analog minimum reached at 20 % MR

MR = Measuring range, SMR = Start of measuring range, EMR = End of measuring range, MV = Master value

The examples demonstrate the behavior of the voltage output and the distance value based on the example of an IMP displacement, measuring range 2 mm.

Target at 16 % measuring range,

$U_{OUT} = 0 \dots 5 \text{ V}$

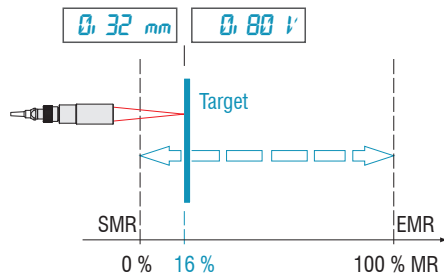

▶ Zero setting (MV = 0 mm)

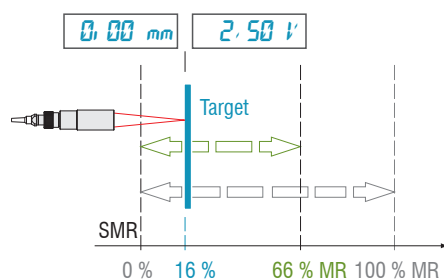

Analog maximum reached at 66 % MR

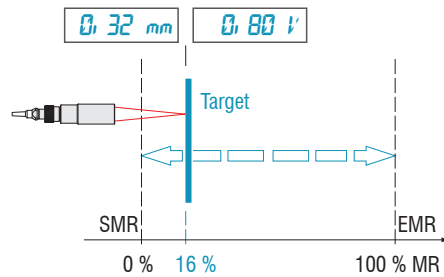

▶ Set master value 0.8 mm

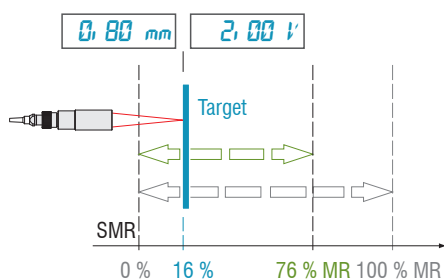

Analog maximum reached at 76 % MR

Target at 60 % measuring range,

$U_{OUT} = 0 \dots 10 \text{ V}$

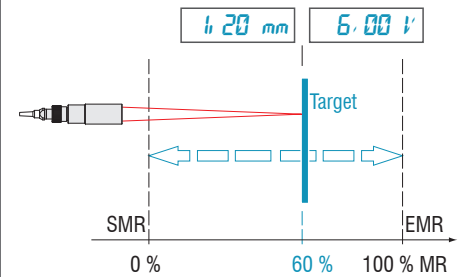

▶ Set master value 0.8 mm

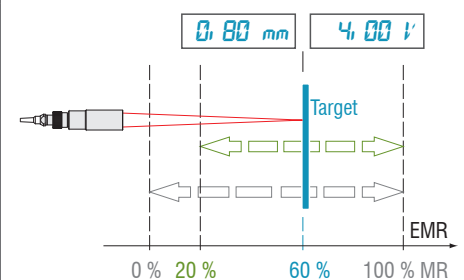

Analog minimum reached at 20 % MR

6.5.3 Error Output, Switching Output

Error output 1 „Error 1“	<i>Intensity error channel 1 / Measuring range error channel 1 / Intensity or measuring range error channel 1</i>	
Error output 2 „Error 2“	<i>Intensity error channel 2 / Measuring range error channel 2 / Intensity or measuring range error channel 2 / Distance is out of limit</i>	
Switching level with error	<i>PNP / NPN / Push pull / Push pull Pull negated</i>	
Limit values	Limit value (in mm)	<i>Value</i>
	Limit value (in mm)	<i>Value</i>
	Function	<i>lower / upper / both</i>

6.5.3.1 Assignment of the Switch Outputs (digital I/O)

Switching outputs “Error 1” and “Error 2” of the “Digital I/O” terminal block can be individually assigned to different errors and thresholds.

Per default, “Error 1” is assigned to intensity errors (F1, peak too high or too low), and “Error 2” corresponds to the signal being outside the measuring range (F2).

Both switching outputs are activated when the measurement object is outside the measuring range.

6.5.3.2 Limit Value Settings

You can also use the “Error 1” and “Error 2” switching outputs to monitor threshold values. If the value exceeds or falls below a defined limit, the switching outputs are activated. In this case, enter lower and upper limit values (in mm).

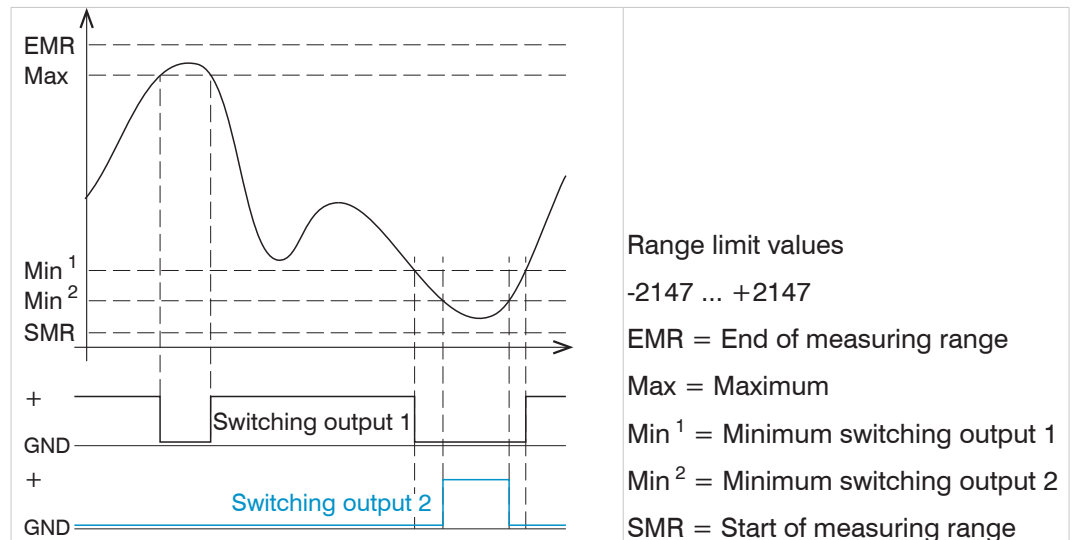

Fig. 73 Switching output 1 (both, NPN) and switching output 2 (lower, PNP) with limit values

6.5.3.3 Switching Logic of Error Outputs

Please refer to the electrical connections, see 4.4.8 for further notes on the switching behavior.

Gray shaded fields require a selection.

Dark-bordered fields require you to specify a value.

6.5.4 Output Interface

Controller IFC2421/2422/2465/2466 has three digital interfaces that can be used as an alternative data output.

- Ethernet: allows fast data transfer, but provides no real-time capabilities (packet-based data transfer). Both measurement and video data can be transferred. Use to capture measurements without any direct process control, for subsequent analysis. Parameterization is provided through the web interface or ASCII commands.
- RS422: provides a real-time capable interface with a lower data rate.
- Error output

6.6 System Settings

6.6.1 Unit Website, Language

The web interface promotes the units millimeter (mm) and inch when displaying measuring results. You can choose German or English in the web interface. You can change language in the menu bar.

6.6.2 Key Lock

The key lock function avoids unauthorized or unintended button operation. The key lock of the `Multifunction` button can be adapted individually.

Key lock	Automatic	Value (1 ... 60 min)	<i>Keylock starts after expiry of a defined time.</i>
	Active		<i>Keylock starts immediately.</i>
	Inactive		<i>No key lock</i>

6.6.3 Load and Save

This chapter explains how to save a setup either based on measurement settings or on device settings. Here you can also find the functions for setup import and setup export, see 5.11.

6.6.4 Access Authorization

Assigning passwords prevents unauthorized changes to controller settings. Password protection is not enabled as a factory setting. The controller works on the `Professional` level. After the controller has been configured, you should enable password protection. The standard password for the Professional level is "000".

- A software update will not change the standard password or a custom password.
- The Professional level password is setup-independent, and is not loaded or stored during setup.

User can do the following:

	User	Professional
Password required	no	yes
View settings	yes	yes
Change settings, change passwords	no	yes
View readings, video signals	yes	yes
Scale graphs	yes	yes
Restore factory settings	no	yes

Fig. 74 Permissions within the user hierarchy

 Gray shaded fields require a selection.

 *Value* Dark-bordered fields require you to specify a value.

⚙ **Access authorization**

Current access authorization:

User ▼

Professional login password:

PASSWORD

Login:

Login

Logout:

Logout

Enter the standard password “000” or a custom password into the `Password` box, and click `Login` to confirm.

Fig. 75 Changing to professional level

The user management enables to define a user-specific password in `Expert` mode.

Password	Value	All passwords are case-sensitive. Numbers are allowed, but special characters are not permitted.
User level when restarting	User / Professional	Defines the user level that is enabled when the sensor starts the next time. MICRO-EPSILON recommend to select Professional level.

6.6.5 Reset Controller

This menu section enables to reset the individual settings to factory settings.

Device settings	Reset the Ethernet and RS422 interfaces to factory settings.
Measurement settings	Resets the preset to <code>Standard mat</code> , the <code>Multifunction button</code> to <code>dark reference</code> and all parameters (except for interface settings) to factory setting.
Reset all	Reset the device and measurement settings to factory settings.
Reset controller	Starts the controller with the last saved settings

6.6.6 Light Source

With the IFC2422 and IFC2466, the light sources can be individually set for both channels.

You can turn on or off the light source for Sensor 1 or Sensor 2.

6.6.7 Change Ethernet to EtherCAT

This setting defines the connection log when the controller is started.

You can switch between Ethernet and EtherCAT via an ASCII command, see A 5.3.7.5, or EtherCAT object, see A 6.2.

Save the current settings before switching to EtherCAT. The switching is done after restarting the controller.

The RS422 interface for transmitting an ASCII command is available both in Ethernet and EtherCAT mode.

7. Thickness Measurement

7.1 One Sensor, Transparent Target

7.1.1 Requirements

In order to measure the thickness of a transparent target from one side, the controller evaluates two signals reflected by the surface. The controller uses both signals to calculate the distances from the targets and thus the thickness can be derived.

- Align the sensor vertically to the target object. Ensure that the target is located near the midrange ($= \text{SMR} + 0.5 \times \text{MR}$)
- The light beam must meet the target surface at a right angle to avoid inaccurate measurements.

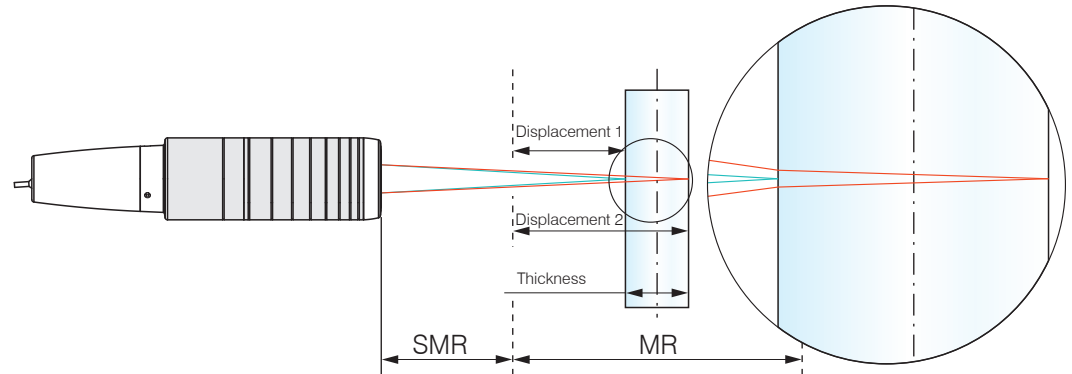

Fig. 76 Single-sided thickness measurement for a transparent object

SMR	Start of measuring range
MR	Measuring range
Minimum target thickness	IFS2403 (hybrid sensor) approx. 15 % of the measuring range IFS2405 (standard sensor) approx. 5 % of the measuring range, see 2.6
Maximum target thickness	Sensor measuring range x refraction index for the target

7.1.2 Preset

- Change to the Home menu.
- Select One-sided thickness measurement in the Measurement configuration.

This preset commands the controller to use the first and second peak in the video signal to calculate the thickness.

7.1.3 Material Selection

Thickness can only be calculated correctly if the material has been specified. To balance the spectral adjustment of the refractive index, a minimum of three refractive index numbers for different wavelengths or one refractive index plus the Abbe number are required.

- Change to the Settings > Data recording > Material selection menu.
- Select the target material in the field Layer 1.

7.1.4 Video Signal

If a target surface is outside the measuring range, the controller provides only one signal for distance, intensity and focus. This might also happen, if one signal is below the detection threshold.

When measuring the thickness of a transparent material, two boundary areas are active. This means, that two peaks are displayed in the video signal, [see Fig. 77](#).

Even if the detection threshold is just below the saddle between the two peaks, the controller can determine both distances and use them to calculate the thickness.

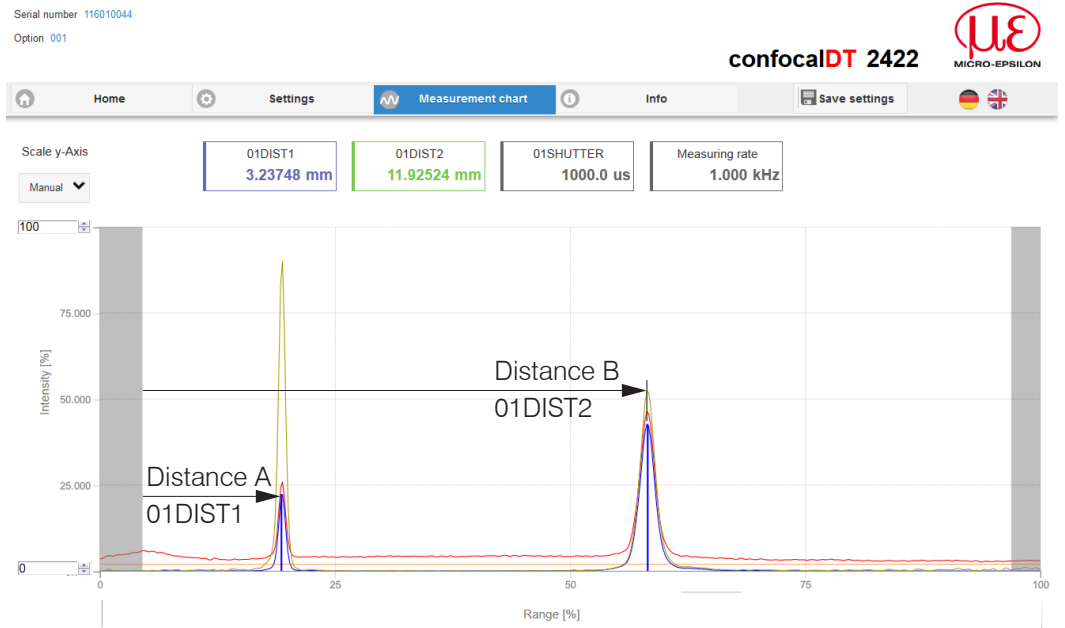

Fig. 77 Video signal web page (thickness measurement)

7.1.5 Signal Processing

The One-side thickness measurement configuration also contains presets for the thickness calculation based on both distance signals Distance1 and Distance2, see Fig. 77.

In the downstream calculation block Calculation 2, the thickness values are subject to a moving average based on a 16 values.

➡ Adapt the signal processing to your measurement task.

7.1.6 Measurement Chart

➡ Change to the Measurement chart and choose the Mess type.

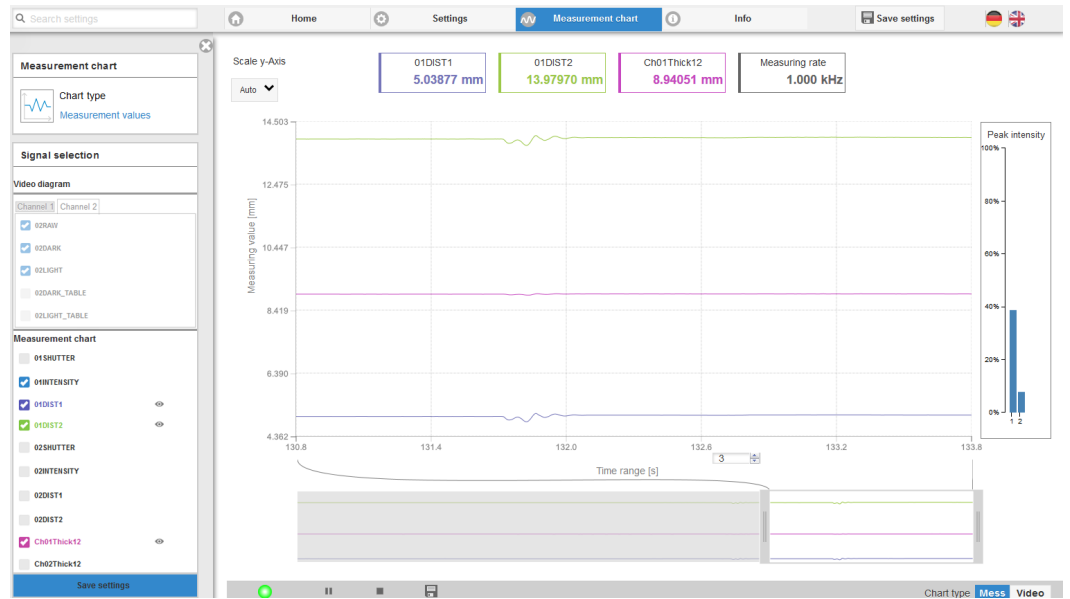

Fig. 78 Thickness measurement results from one-sided thickness measurement using one sensor

The website displays both distances and the thickness (difference from 01DIST2 and 01DIST1) in graphical and numerical form. The intensities for both peaks (peak 1 = close, peak 2 = far) can be optionally displayed.

7.2 Thickness Measurement with Two Sensors

7.2.1 Requirements

In order to achieve a two-sided thickness measurement, two sensors arranged opposite to each other measure against the target. The controller evaluates the signals reflected by the surface. The controller uses both signals to calculate the distances from the targets and thus the thickness can be derived.

➡ Align both sensors vertically to the target object. Ensure that the target is located near the midrange (= $SMR + 0.5 \times MR$)

- The light beam must meet the target surface at a right angle to avoid inaccurate measurements..

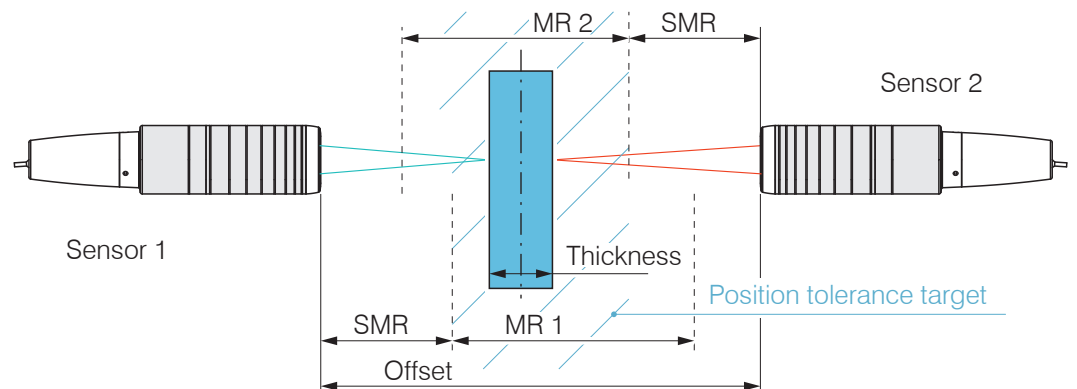

Fig. 79 Thickness measurement of a target from two sides

- SMR Start of measuring range
- MR Measuring range
- Maximum target thickness Intersection of both sensor measuring ranges

7.2.2 Preset

- ➡ Change to the Home menu.
- ➡ Select Two side thickness in the Measurement configuration.

This preset commands the controller to use the first peak in the video signal to calculate the thickness.

7.2.3 Video Signal

If one target surface is outside the measuring range, the controller provides only one signal for distance, intensity and focus. This might also happen, if one signal is below the detection threshold.

Even if the detection threshold is just below the saddle between the two peaks, the controller can determine both distances and use them to calculate the thickness.

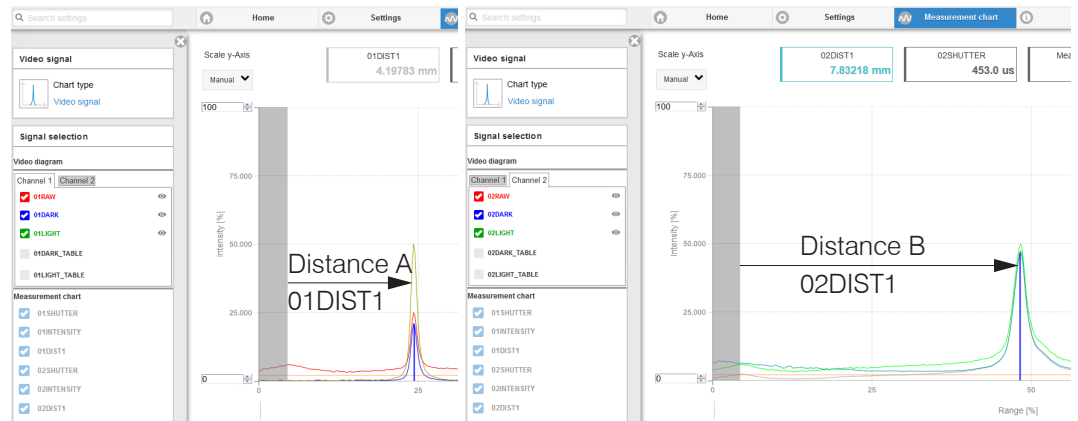

Fig. 80 Video signal web page displays both channels

- ➡ You can switch between both channels, monitor the intensity of the video signals and adjust, if required, the measuring rate in order to increase the intensity.

7.2.4 Postprocessing

The Two-sided thickness measurement configuration also contains presets for the thickness calculation based on the distance signals Distance 1 and Distance 2.

In the calculation block Calculation 1, the distance signals 01DIST1 and 02DIST1 are subtracted from the Offset distance between the sensors.

- ➡ Adapt the offset value to your measurement arrangement. Value range [-2048 ... 2047].
- ➡ Save the change by clicking on Store calculation.

In the downstream calculation block Calculation 2, the thickness values are subject to a moving average based on a 16 values.

- ➡ Adapt the postprocessing to your measurement task.

7.2.5 Measurement Chart

➡ Change to the Measurement chart and choose the Mess type.

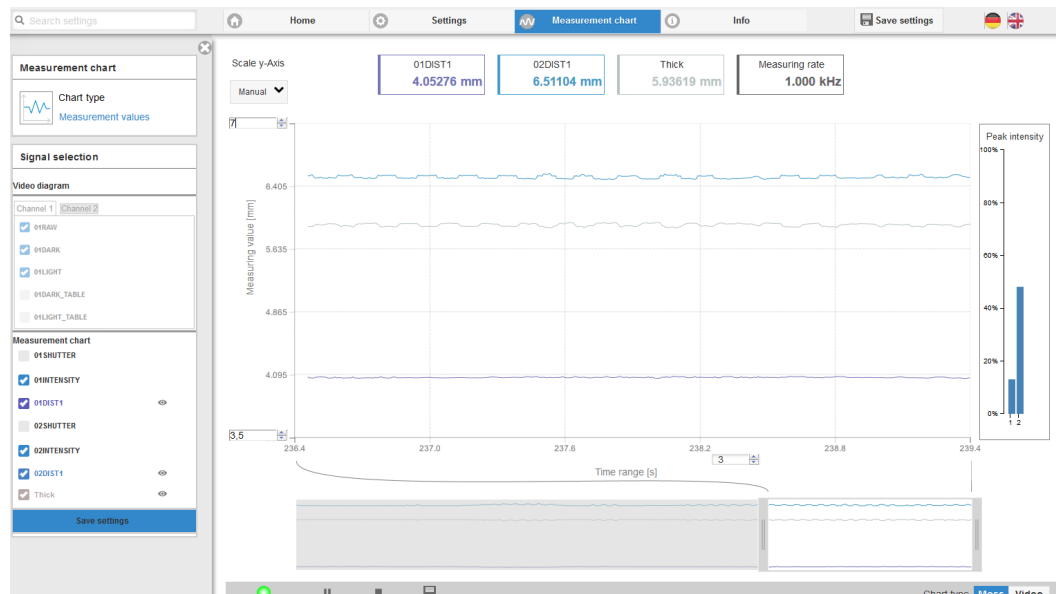

Fig. 81 Results from two-sided thickness measurement using two sensors

The website displays the distances (01DIST2 and 01DIST1) and the thickness Thick in graphical and numerical form. The intensities for both peaks (peak 1 = close, peak 2 = far) can be optionally displayed.

8. Errors, Repair

8.1 Web Interface Communication

- If an error page is displayed in the web browser, please check the following:
 - Check if the controller is connected correctly, [see 5.1](#).
 - Check the IP configuration for PC and controller, and check if `sensorTOOL` can locate the controller, [see 5.2.1](#).
If controller and PC are connected directly, IP address detection may take up to 2 minutes.
 - Check the proxy settings. If the controller uses a separate network adapter to connect to the PC, you need to disable the use of a proxy server for this connection. Contact your network specialist or administrator!

8.2 Changing the Sensor Cable for IFS2405 and IFS2406 Sensor

- Disconnect the protective sleeve from the sensor. Remove the damaged sensor cable.
- Guide the new sensor cable through the protective sleeve.
- Remove the protective cap on the sensor cable and keep it.
- Guide the locking pin of the sensor cable into the connector cavity.
- Screw together the sensor's connector and socket ends.
- Screw the protective sleeve back onto the sensor.
- Run the dark reference, [see 5.5](#).



8.3 Changing the Protective Glass for IFS2405 and IFS2406 Sensors

Changing the protective glass is required for

- irreversible pollution.
- scratches.

i Do not use the sensor without a protective glass, because this leads to a lower measurement accuracy.

8.3.1 IFS2405/IFS2406

- Loose the front socket with the protective glass from the sensor.



- Remove the seal and place the O-ring into the frame groove of the new socket.
- Screw the new socket with the protective glass back onto the sensor.

8.3.2 IFS2406/90-2,5

- ➡ Loosen the grub screws on the sensor, see Fig. 82, and slide the protective glass aside, see Fig. 83.



Fig. 82 View on sensor from above



Fig. 83 View on sensor from below

- ➡ Slide the new protective glass flush back and clamp the protective glass with the two grub screws again firmly.

9. Software Update

Requirements for software update

➡ Connect the controller („Ethernet“ female connector) to a PC using an Ethernet direct connection (LAN). Use a LAN cable with RJ-45 connectors.

• A software update does not affect the parameter settings. Newly added parameters are set to default values.

Update

You will find the latest firmware update tool `Update_Sensor_Ethernet.exe` on our website:

www.micro-epsilon.com/download/software/confocalCDT_Update_Sensor_Ethernet.zip

You can get the latest firmware under www.micro-epsilon.com/service/download/software/ in the section `confocalDT - Confocal Sensors`.

If you have any questions, please feel free to contact the relevant sales person in our company.

10. Software Support with MEDAQLib

The Micro-Epsilon Data Acquisition Library offers you a high level interface library to access confocal displacement sensors from your Windows application in combination with The Micro-Epsilon Data Acquisition Library offers you a high level interface library to access confocal displacement sensors from your Windows application in combination with into an existing or a customized PC software.

The Micro-Epsilon Data Acquisition Library offers you a high level interface library to access confocal displacement sensors from your Windows application in combination with

- RS422/USB converter (optional accessory) and a suitable SC2471-x/USB/IND cable or
- IF2008 PCI interface card and SC2471-x/IF2008 cable or
- Ethernet

You need no knowledge about the controller protocol to communicate with the individual controllers. The individual commands and parameters for the controller to be addressed will be set with abstract functions. MEDAQLib translates the abstract functions in comprehensible instructions for the controller.

MEDAQLib

- contains a DLL, which can be imported into C, C++, VB, Delphi and many additional programs,
- makes data conversion for you,
- works independent of the used interface type,
- features by identical functions for the communication (commands),
- provides a consistent transmission format for all MICRO-EPSILON sensors.

For C/C++ programmers MEDAQLib contains an additional header file and a library file,

You will find the latest driver / program routine at:

www.micro-epsilon.com/download

www.micro-epsilon.com/link/software/medaqlib

11. Disclaimer

All components of the device have been checked and tested for functionality in the factory. However, should any defects occur despite careful quality control, these shall be reported immediately to MICRO-EPSILON or to your distributor / retailer.

MICRO-EPSILON undertakes no liability whatsoever for damage, loss or costs caused by or related in any way to the product, in particular consequential damage, e.g., due to

- non-observance of these instructions/this manual,
- improper use or improper handling (in particular due to improper installation, commissioning, operation and maintenance) of the product,
- repairs or modifications by third parties,
- the use of force or other handling by unqualified persons.

This limitation of liability also applies to defects resulting from normal wear and tear (e.g., to wearing parts) and in the event of non-compliance with the specified maintenance intervals (if applicable).

MICRO-EPSILON is exclusively responsible for repairs. It is not permitted to make unauthorized structural and / or technical modifications or alterations to the product. In the interest of further development, MICRO-EPSILON reserves the right to modify the design.

In addition, the General Terms of Business of MICRO-EPSILON shall apply, which can be accessed under Legal details | Micro-Epsilon <https://www.micro-epsilon.com/impresum/>.

For translations into other languages, the German version shall prevail.

12. Service, Repair

If the sensor, controller or sensor cable is defective:

- If possible, save the current controller settings in a parameter set, [see 5.11](#), in order to load again the settings back into the controller after the repair.
- Please send us the affected parts for repair or exchange.

If the cause of a fault cannot be clearly identified, please send the entire measuring system to

MICRO-EPSILON
MESSTECHNIK GmbH & Co. KG
Koenigbacher Str. 15
94496 Ortenburg / Germany

Tel. +49 (0) 8542 / 168-0
Fax +49 (0) 8542 / 168-90
info@micro-epsilon.com
www.micro-epsilon.com

13. Decommissioning, Disposal

In order to avoid the release of environmentally harmful substances and to ensure the reuse of valuable raw materials, we draw your attention to the following regulations and obligations:

- Remove all cables from the sensor and/or controller.
- Dispose of the sensor and/or the controller, its components and accessories, as well as the packaging materials in compliance with the applicable country-specific waste treatment and disposal regulations of the region of use.
- You are obliged to comply with all relevant national laws and regulations.

For Germany / the EU, the following (disposal) instructions apply in particular:

- Waste equipment marked with a crossed garbage can must not be disposed of with normal industrial waste (e.g. residual waste can or the yellow recycling bin) and must be disposed of separately. This avoids hazards to the environment due to incorrect disposal and ensures proper recycling of the old appliances. 
- A list of national laws and contacts in the EU member states can be found at https://ec.europa.eu/environment/topics/waste-and-recycling/waste-electrical-and-electronic-equipment-weee_en. Here you can inform yourself about the respective national collection and return points.
- Old devices can also be returned for disposal to MICRO-EPSILON at the address given in the imprint at <https://www.micro-epsilon.de/impressum/>.
- We would like to point out that you are responsible for deleting the measurement-specific and personal data on the old devices to be disposed of.
- Under the registration number WEEE-Reg.-Nr. DE28605721, we are registered at the foundation Elektro-Altgeräte Register, Nordostpark 72, 90411 Nuremberg, as a manufacturer of electrical and/or electronic equipment.

Appendix

A 1 Accessories, Services

A 1.1 Accessories

Accessories IFS2402, IFS2403

CE2402-x	Sensor cable extension for IFS2402 sensors, length x = 3 m, 10 m, 30 m, 50 m
CE2402-x/PT	Sensor with protective tubing, length x = 3 or 10 m, customer-specific up to 50 m

Accessories IFS2404

C2404-2	Sensor cable IFS2404 sensors, length x = 2 m
---------	--

Accessories IFS2405, IFS2406, IFS2407-0,1

C2401 cable with FC/APC and E2000/APC connectors

C2401-x	Optical fiber (3 m, 5 m, 10 m, customer-specific length up to 50 m)
C2401/PT-x	Optical fiber with protection tube for mechanical stress (3 m, 5 m, 10 m, customer-specific length up to 50 m)
C2401-x(01)	Optical fiber core diameter 26 μm (3 m, 5 m, 15 m)
C2401-x(10)	Drag-chain suitable optical fiber (3 m, 5 m, 10 m)

C2400 cable with 2x FC/APC connector

C2400-x	Optical fiber (3 m, 5 m, 10 m, customer-specific length up to 50 m)
C2400/PT-x	Optical fiber with protection tube for mechanical stress (3 m, 5 m, 10 m, customer-specific length up to 50 m)
C2400/PT-x.Vac	Optical fiber with protection tube suitable for use in vacuum (3 m, 5 m, 10 m, customer-specific length up to 50 m)

Installation bracket

MA2400-27	Installation bracket for IFS2405-0,3 / IFS2405-1 / IFS2406-3 / IFS2406-10 sensors
MA2402-4	Installation bracket for IFS2402-x sensors
MA2403-8	Installation bracket for IFS2403-x sensors
MA2404-12	Installation bracket for IFS2404-x / IFS2407-0,1 / IFS2407-0,8 sensors
MA2405-34	Installation bracket for IFS2405-3 sensors
MA2405-40	Installation bracket for IFS2405-6 / IFS2405/90-6 sensors
MA2405-54	Installation bracket for IFS2405-10 / IFS2407-3 sensors
MA2405-62	Installation bracket for IFS2405-28 / IFS2405-30 sensors
MA2406-20	Installation bracket for IFS2406-2,5 sensors
JMA-xx	Adjustable Mounting Adapter, see A 3

Accessories IFS2407/90-0,3

C2407-x	Optical fiber with DIN connector and E2000/APC (2 m, 5 m)
---------	---

Accessories light source

IFL2422/LED	Lamp module for IFC2422 / IFC2466
IFL24x1/LED	Lamp module for IFC24x1
Optical fiber reflector	Reflector for E2000/APC

Other accessories

SC2471-x/IF2008	Connector cable IFC2451/61/71-IF2008, length 3 m, 10 m or 20 m
SC2471-x/RS422/OE	Interface cable for interface IF2030, length 3 m, 10 m
SC2471-3/IF2008ETH	Interface cable for interface IF2008/ETH, length 3 m
IF2001/USB	Converter RS422 to USB, type IF2001/USB, useable for cable SC2471-x/RS422/OE, inclusive driver, connections: 1 × female connector 10-pin (cable clamp) type Würth 691361100010, 1x female connector 6-pin (cable clamp) type Würth 691361100006
IF2004/USB	4-channel RS422/USB converter for one to four optical sensors with RS422 interface, data output via USB interface A 24VDC/2A power supply unit is required for operation (not included).
IF2008/PCIE	Interface card IF2008/PCIE to capture four digital sensor signals synchronously, confocalDT 2421/2422/2451/2461/2465/2466/2471 series and two encoders. In conjunction with IF2008E a total of six digital signals, two encoders, two analog signals and eight I/O signals can be captured synchronously.
IF2008/ETH	8-fold RS422/Ethernet converter with industrial M12 plug/socket to connect up to 8 2421/2422/2451/2461/2465/2466/2471 controllers
IF2030/PNET	Interface component to connect an IFC242x/2451/2461/2471 controller to Profinet, housing for top-hat rail, software integration into PLC with GSDML file, certified according to PNIO V2.33
PS2020	Power supply unit for DIN rail mounting, input 230 VAC, output 24 VDC/2.5 A
EC2471-3/OE	Encoder cabel, 3 m

Vacuum feed trough

C2402/Vac/KF16	Vacuum feed trough for optical fiber, 1 channel, vacuum side FC/APC non-vacuum side E2000/APC, clamping flange type KF 16
C2405/Vac/1/KF16	Vacuum feed through on both sides FC/APC socket, 1 channel, clamping flange type KF 16
C2405/Vac/1/CF16	Vacuum feed through on both sides FC/APC socket, 1 channel, flange type CF 16
C2405/Vac/6/CF63	Vacuum feed through for optical fiber, on both sides FC/APC socket, 6 channels, flange type CF 63

A 1.2 Services:

- Linearity tests and adjustments for the confocalDT measuring system
- Calibration of the confocalDT measuring system

A 2 Factory Settings

User level	Professional, password „000“
Number of peaks	1 measurement, highest peak
Peak separation	2 %
RS422	115.200 KBaud
Triggering	no trigger
Language	de
Synchronization	Inactive
Key function 1	Dark reference
Measuring rate	1 kHz
Key lock	Inactive

Measurement programm	Displacement measurement
Peak modulation	50 %
Error handling	Error output, no measurement
Ethernet	Static IP, IP address 169.254.168.150
Switching output 1	Intensity error channel 1
Switching output 2	Measuring range error channel 1
Exposure mode	Measurement mode
Key function 2	Inactive
Data output	Webinterface and analog output with 4 ... 20 mA

A 3 Adjustable Mounting Adapter JMA-xx

A 3.1 Functions

- Supports optimal sensor alignment for best possible measurement results
- Manual adjustment mechanism for easy and fast adjustment
 - Shift in X/Y: ± 2 mm
 - Tilt angle: $\pm 4^\circ$
- High resistance to shocks and vibrations due to radial clamping allows integration into machines
- Compatible with numerous confocalDT and interferoMETER sensor models

A 3.2 Sensor Mounting, Compatibility

Radial clamping for sensors with

\varnothing 8 mm	\varnothing 12 mm	\varnothing 20 mm	\varnothing 27 mm
Reducing sleeve			
D27-D8 adapter	D27-D12 adapter	D27-D20 adapter	
confocalDT: IFS2403 series	confocalDT: IFS2404-2 IFS2407-0,1 IFS2407-0,8	confocalDT: IFS2406-2,5/VAC	confocalDT: IFS2405-0,3 IFS2405-1 IFS2406-3 IFS2406-10

A 3.3 Assembly

- ➔ Mount the sensor in the mounting ring, see figure.
- ➔ Use reducing sleeves for sensors with an outer diameter of less than 27 mm.
- ➔ Mount the mounting adapter with screws type M4, see dimensional drawing.

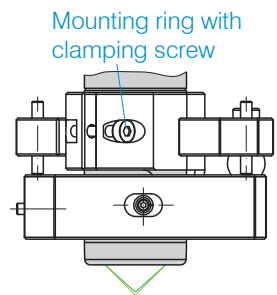

A 3.4 Dimensional Drawing of Mounting Adapter

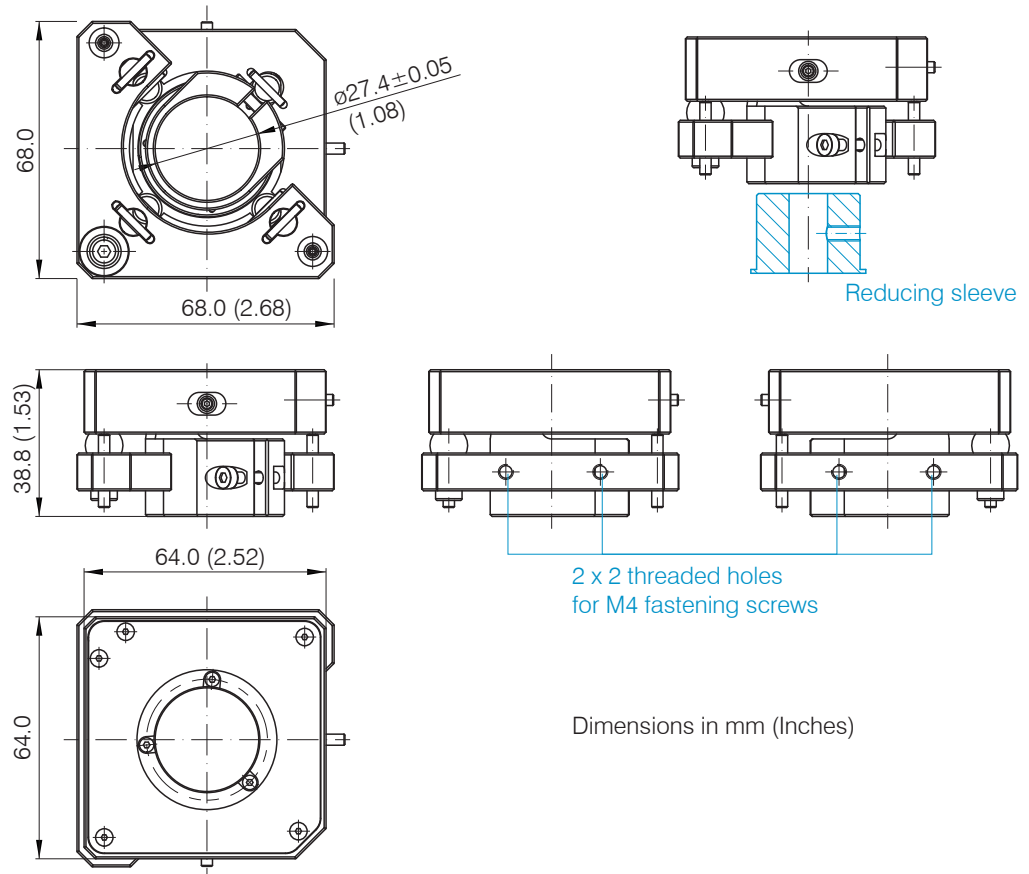

A 3.5 Perpendicular Alignment of Sensor

➡ With the light source switched on, align the sensor with the measuring object.

Horizontal shift ± 2 mm



Shift to the left:

➡ Turn the hexagon socket screw clockwise

Shift to the right:

➡ Turn the hexagon socket screw counterclockwise

Horizontal tilt angle $\pm 4^\circ$



Tilt to the left:

➡ Turn the hexagon socket screw clockwise

Tilt to the right:

➡ Turn the hexagon socket screw counterclockwise

Vertical shift ± 2 mm

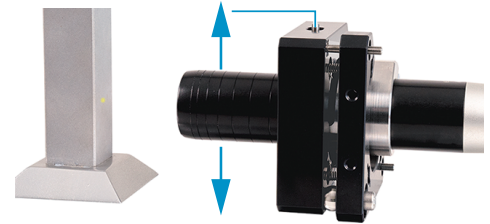

Shift downwards:

➡ Turn the hexagon socket screw clockwise

Shift upwards:

➡ Turn the hexagon socket screw counterclockwise

Vertical tilt angle $\pm 4^\circ$

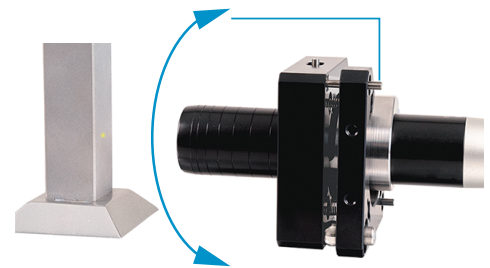

Tilt downwards:

➡ Turn the hexagon socket screw clockwise

Tilt upwards:

➡ Turn the hexagon socket screw counterclockwise

A 4 Cleaning Optical Components

A 4.1 Contamination

Contaminated boundary surfaces and components can cause an increase in dark value and will affect sensitivity and accuracy. To avoid this, it is necessary to clean the optical components and record the dark value. The dark value refers to the interfering reflections at boundary surfaces along the optical signal path. At each boundary surface or material transition, the light waves are reflected to a certain extent at the transition and travel back in the fiber optics. The interfering signal overlaps with the useful signal and forms a kind of signal noise.

If the interference signal is sufficiently high and the useful signal is relatively weak, the useful signal can no longer be clearly identified. This may cause the controller to confuse a dark value peak with the measurement signal. The calculated distance of the measuring object therefore does not match the actual one.

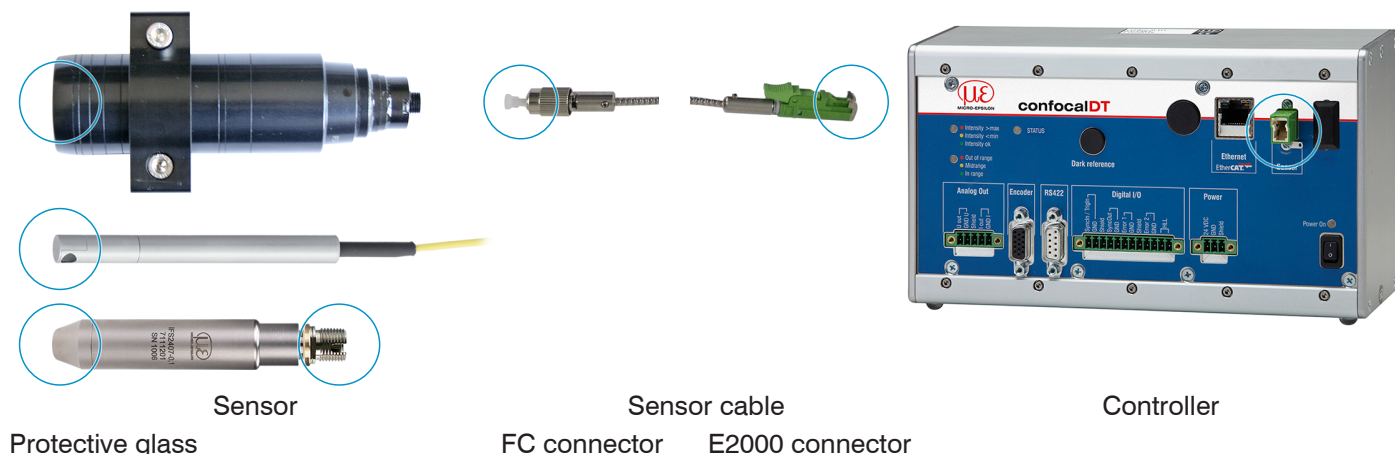
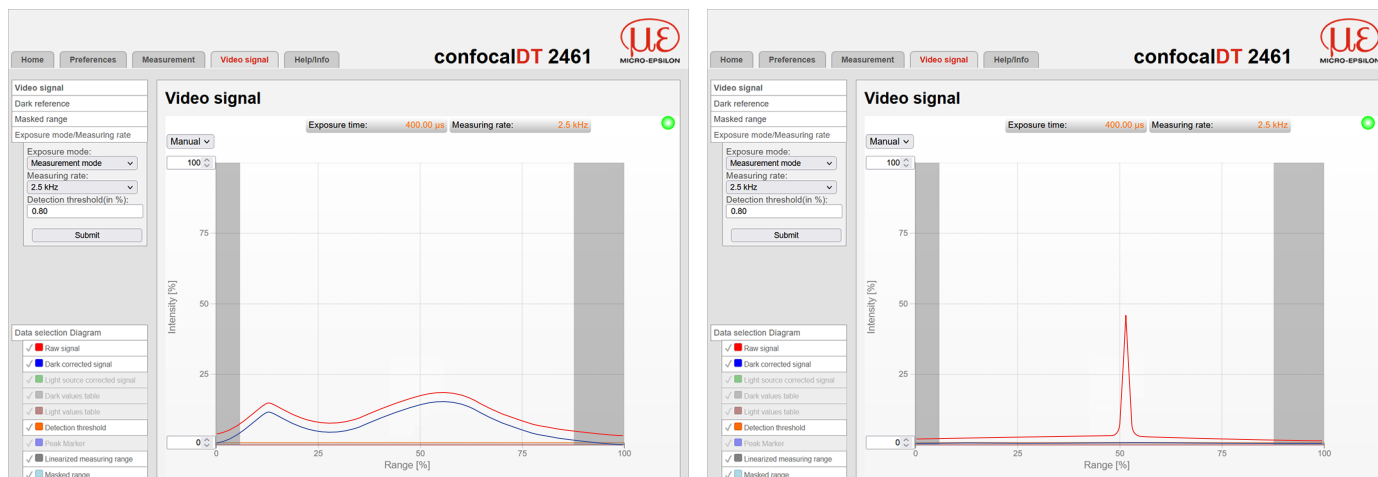

Fig. 84 Optical boundary surfaces of a confocal measuring system

▶ Perform dark referencing.

The operating instructions for the system describe how to perform dark referencing, see 5.5.







Video signal before dark reference (high dark value, blue line) Video signal after dark reference

If the video signal corresponds to the condition before the dark reference, you must clean the optical boundary surface within the measuring system. Clean the optical surfaces one by one to find the dirty component. You can observe how cleaning improves the result by watching the dark signal of the video signal.

▶ Continue with the section Protective Glass of Sensor.

- Check and clean the protective glass of the sensor at regular intervals depending on the operating conditions.
- 1 Clean the system starting from the controller to the sensor. Always clean both components of a matched pair, i.e. plug and socket.

A 4.2 Tools and Cleaning Agents

One-Click™ cleaner	Isopropyl alcohol	Q-Tip, suitable for clean rooms	Pressurized gas, dry and oil-free
			
For FC or E2000 type plug or socket	For the protective glass of the sensor	Use with isopropyl alcohol for protective glass of the sensor	Removes loose particles

A 4.3 Protective Glass of Sensor

Loose particles

- ➡ Blow off loose particles with dry, oil-free pressurized air.

Stuck particles

- ➡ Clean the protective glass with a clean, soft, lint-free cloth or lens cleaning paper and pure alcohol (isopropyl alcohol).

For sensors with a small protective glass, e.g., the IFS2403 series:

- ➡ Soak a Q-Tip in isopropyl alcohol. Slowly rub the Q-Tip with a circular motion on the protective glass.



Fig. 85 Protective glass, sensors for radial measurement

- ➡ Perform dark referencing.

If the video signal corresponds to the condition before the dark reference, you must clean the boundary surface within the measuring system.

- ➡ Continue with the section `Interface between Controller and Sensor Cable`.

A 4.4 Interface between Controller and Sensor Cable

- ▶ Disconnect the sensor cable (fiber optic cable) from the controller.
- ▶ Remove the protective cap of the One-Click™ cleaner.
- ▶ Put the One-Click™ cleaner into the fiber optic connector of the controller, see figure.
- ▶ Press the outer sleeve of the One-Click™ cleaner onto the fiber optic connector until a click noise signals the end of cleaning.

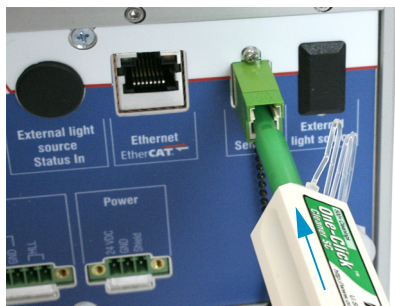
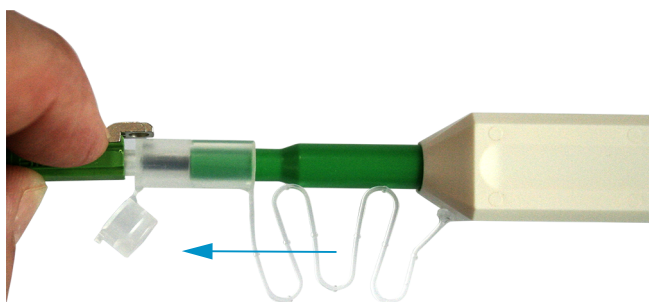

Fig. 86 One-Click™ for cleaning E2000 optical fiber transitions

- ▶ Insert the protective cap on the controller into the fiber optic connector.
- ▶ Remove the protective front cap of the One-Click™ cleaner.
- ▶ Put the One-Click™ cleaner into the fiber optic cable, see figure.
- ▶ Press the outer sleeve of the One-Click™ cleaner onto the fiber optic cable until a click noise signals the end of cleaning.



- ▶ Plug the sensor cable into the controller.
- ▶ Perform dark referencing.

If the video signal corresponds to the condition before the dark reference, you must clean the boundary surface within the measuring system.

- ▶ Continue with the section `Interface between Sensor Cable and Sensor`.

A 4.5 Interface between Sensor Cable and Sensor

- Remove the sensor cable (fiber optic cable) from the sensor.
- Remove the protective front cap of the One-Click™ cleaner.
- Put the One-Click™ cleaner into the fiber optic cable, see figure.
- Press the outer sleeve of the One-Click™ cleaner onto the fiber optic cable until a click noise signals the end of cleaning.

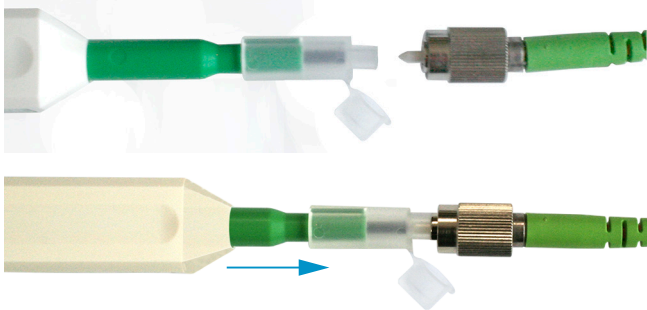

- Put a protective cap on the fiber optic cable.

Sensors with fiber optics, e.g. IFS2407 series:

- Remove the protective cap of the One-Click™ cleaner.
- Put the One-Click™ cleaner into the sensor, see figure.
- Press the outer sleeve of the One-Click™ cleaner onto the sensor until a click noise signals the end of cleaning.



- Connect the sensor cable to the sensor.
- Perform dark referencing.

If the video signal corresponds to the condition before the dark reference, you must clean the boundary surface within the measuring system.

- Continue with the section `Interface between Controller and Sensor Cable`.

A 4.6 Preventive Protection

Sensors and controllers of a confocal chromatic sensor system are supplied with protective caps. This prevents dust or similar contaminants from being deposited at the optical boundary surfaces.

- Cover all optical fiber connections immediately when replacing sensors or disconnecting a sensor cable from the controller.

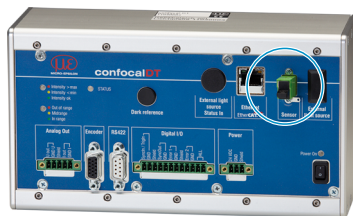

A 5 ASCII Communication with Controller

A 5.1 General

The ASCII commands can be sent to the controller via the RS422 interface or Ethernet (Port 23). All commands, inputs and error messages are in English. A command always consists of the command name and zero or more parameters, which are separated by spaces and are completed with LF. If spaces are used in parameters, the parameters must be placed in quotation marks (e.g. "password with spaces").

Example: Switch on the output via RS422

OUTPUT RS422 ←↵

Advice: ←↵ must include LF, but may also be CR LF.

Declaration: LF Line feed (line feed, hex 0A)

CR Carriage return (carriage return, hex 0D)

←↵ Enter (depending on the system hex 0A or hex 0D0A)

The currently set parameter value is returned, if a command is activated without parameters.

The output format is:

<Command name> <Parameter1> [<Parameter2> [...]]

The reply can be used again as command for the parameter setting without changes. In this case, optional parameters are returned only where necessary.

After processing a command, the system always returns a line break and a command prompt. In the event of an error, an error message starting with "Exx" will appear before the prompt, where xx represents a unique error number. In addition, the system may display a warning ("Wxx") instead of an error message. Warnings are structured like error messages, such as "If Xenon lamp is too hot..." Warnings do not prevent commands from being executed.

A 5.2 Commands Overview

Group	Chapter	Command	Short description
General			
	Chap. A 5.3.1.1	HELP	Help
	Chap. A 5.3.1.2	GETINFO	Controller Information
	Chap. A 5.3.1.3	ECHO	Reply Type
	Chap. A 5.3.1.4	PRINT	Parameter Overview
	Chap. A 5.3.1.5	SYNC	Synchronization
	Chap. A 5.3.1.6	TERMINATION	Termination Resistor
	Chap. A 5.3.1.7	RESET	Booting the Sensor
	Chap. A 5.3.1.8	RESETCNT	Reset Controller
Web interface			
	Chap. A 5.3.2.1	LANGUAGE	Language
	Chap. A 5.3.2.2	UNIT	Unit Website, Language
User Level			
	Chap. A 5.3.3.1	LOGIN	Changing the User Level
	Chap. A 5.3.3.2	LOGOUT	Changing to User Level
	Chap. A 5.3.3.3	GETUSERLEVEL	Querying the User Level
	Chap. A 5.3.3.4	STDUSER	Defining a Standard User
	Chap. A 5.3.3.5	PASSWD	Changing the Password

Sensor			
	Chap. A 5.3.4.1	SENSORTABLE	Displays Available Sensors
	Chap. A 5.3.4.2	SENSORHEAD	Sensor Selection
	Chap. A 5.3.4.3	SENSORINFO	Sensor Information
	Chap. A 5.3.4.4	DARKCORR	Starts Dark Reference
	Chap. A 5.3.4.5	DARKCORRTHRES	Warning Threshold in the Event of Contamination
	Chap. A 5.3.4.6	LED	LED On/Off
Triggering			
	Chap. A 5.3.5.1	TRIGGERSOURCE	Select Trigger Source
	Chap. A 5.3.5.2	TRIGGERAT	Effect of the Trigger Input
	Chap. A 5.3.5.3	TRIGGERMODE	Trigger Type
	Chap. A 5.3.5.4	TRIGGERLEVEL	Active Level Trigger Input
	Chap. A 5.3.5.5	TRIGGERSW	Create a software trigger pulse
	Chap. A 5.3.5.6	TRIGGERCOUNT	Number of Output Measurement Values
	Chap. A 5.3.5.7	TRIGINLEVEL	Trigger Level TrigIn (TTL / HTL)
	Chap. A 5.3.5.8	TRIGGERENCSTEPSIZE	Step Size Encoder Triggering
	Chap. A 5.3.5.9	TRIGGERENCMIN	Minimum Encoder Triggering
	Chap. A 5.3.5.10	TRIGGERENCMAX	Maximum Encoder Triggering
Encoder			
	Chap. A 5.3.6.1	ENCINTERPOLn	Setting Interpolation Depth
	Chap. A 5.3.6.2	ENCREFn	Setting the reference track
	Chap. A 5.3.6.3	ENCVALUEn	Setting Encoder Value
	Chap. A 5.3.6.4	ENCSET	Setting Encoder Value
	Chap. A 5.3.6.5	ENCRESET	Reset Encoder Value
	Chap. A 5.3.6.6	ENCMAXn	Setting Maximum Encoder Value
Interfaces			
	Chap. A 5.3.7.1	IPCONFIG	Ethernet Settings
	Chap. A 5.3.7.2	MEASTRANSFER	Setting the Measured Value Server
	Chap. A 5.3.7.3	MEASCNT_ETH	Measurements per frame
	Chap. A 5.3.7.4	BAUDRATE	RS422 Setting
	Chap. A 5.3.7.5	ETHERMODE	Switching between Ethernet and EtherCAT
Parameter Management, Load / Save Settings			
	Chap. A 5.3.8.1	BASICSETTINGS	Load Connection Settings
	Chap. A 5.3.8.2	CHANGESSETTINGS	Show Changed Parameters
	Chap. A 5.3.8.3	EXPORT	Export of Parameter Sets
	Chap. A 5.3.8.4	IMPORT	Import of Parameter Sets
	Chap. A 5.3.8.5	SETDEFAULT	Reset to Factory Settings
	Chap. A 5.3.8.6	MEASSETTINGS	Edit Measurement Settings
Measurement			
	Chap. A 5.3.9.1	PEAKCOUNT	Number of Peaks
	Chap. A 5.3.9.2	MEASPEAK	Peak Selection
	Chap. A 5.3.9.3	REFRACCORR	Refractive Correction
	Chap. A 5.3.9.4	SHUTTERMODE	Exposure Mode
	Chap. A 5.3.9.5	MEASRATE	Measuring Rate
	Chap. A 5.3.9.6	SHUTTER	Exposure Time
	Chap. A 5.3.9.7	ROI	Masking the Evaluation Range
	Chap. A 5.3.9.8	MIN_THRESHOLD	Peak Detection Threshold
	Chap. A 5.3.9.9	PEAK_MODULATION	Peak Modulation

Material Data Base			
	Chap. A 5.3.10.1	MATERIALTABLE	Material Table
	Chap. A 5.3.10.2	MATERIAL	Select Material
	Chap. A 5.3.10.3	MATERIALINFO	Display Material Properties
	Chap. A 5.3.10.4	MATERIALEDIT	Edit Material Table
	Chap. A 5.3.10.5	MATERIALDELETE	Delete a Material
	Chap. A 5.3.10.6	MATERIALMP	Material Settings
Measurement Value Processing			
	Chap. A 5.3.11.1	SPIKECORR	Spike Correction
	Chap. A 5.3.11.2	STATISTIC	Selection of a Signal for the Statistics
	Chap. A 5.3.11.3	META_STATISTIC	List of Possible Signals for the Statistics
	Chap. A 5.3.11.4	RESETSTATISTIC	Reset the Statistics Calculation
	Chap. A 5.3.11.5	STATISTICSIGNAL	Selection of a Signal for the Statistics
	Chap. A 5.3.11.6	META_STATISTICSIGNAL	List of Possible Signal for the Statistics to be Selected
	Chap. A 5.3.11.7	META_MASTERSIGNAL	List of Signals which can be Parameterized
	Chap. A 5.3.11.8	MASTERSIGNAL	Master Signal Parameterization
	Chap. A 5.3.11.9	META_MASTER	List of Possible Signals for Mastering
	Chap. A 5.3.11.10	MASTER	Activate Mastering
	Chap. A 5.3.11.12	COMP	Channel Selection
	Chap. A 5.3.11.13	META_COMP	List of Possible Calculation Signals
	Chap. A 5.3.11.14	SYSSIGNALRANGE	Two-Point Scaling Data Outputs
Data Output			
	Chap. A 5.3.12.1	OUTPUT	Selection of Digital Output
	Chap. A 5.3.12.2	OUTREDUCEDEVICE	Data Output Rate
	Chap. A 5.3.12.3	OUTREDUCECOUNT	Reduction Counter
	Chap. A 5.3.12.4	OUTHOLD	Error Processing
Select Measurement Values to be Output via Interfaces			
	Chap. A 5.3.13.2	OUT_ETH	Data selection for Ethernet
	Chap. A 5.3.13.3	META_OUT_ETH	List of Possible Ethernet Signals
	Chap. A 5.3.13.4	GETOUTINFO_ETH	List of Selected Signals, Transfer Sequence via Ethernet
	Chap. A 5.3.13.5	OUT_RS422	Data selection for RS422
	Chap. A 5.3.13.6	META_OUT_RS422	List of Possible RS422 Signals
	Chap. A 5.3.13.7	GETOUTINFO_RS422	List of Selected Signals, Transfer Sequence via RS422
Switching Outputs			
	Chap. A 5.3.14.1	ERROROUTn	Selection of Error Signal for Output
	Chap. A 5.3.14.2	ERRORLIMITSIGNALn	Setting the Signal to be Evaluated
	Chap. A 5.3.14.3	META_ERRORLIMITSIGNAL	List of Possible Signals for Error Output
	Chap. A 5.3.14.4	ERRORLIMITCOMPARETO	Setting Limit Values
	Chap. A 5.3.14.5	ERRORLIMITVALUESn	Setting Value
	Chap. A 5.3.14.6	ERRORLEVELOUTn	Switching Behavior of Error Outputs

Analog Output			
	Chap. A 5.3.15.1	ANALOGOUT	Data Selection for Analog Output
	Chap. A 5.3.15.2	META_ANALOGOUT	List of Possible Signals Analog Output
	Chap. A 5.3.15.3	ANALOGRANGE	Setting Current/Voltage Range of Digital-Analog Converter (DAC)
	Chap. A 5.3.15.4	ANALOGSCALEMODE	Setting the Scaling of DAC
	Chap. A 5.3.15.5	ANALOGSCALERANGE	Setting the Scaling Range
Key Functions			
	Chap. A 5.3.16.1	KEYFUNC	Activating Multifunction Button
		KEYMASTERSIGNALSELECT	
	Chap. A 5.3.16.3	KEYLOCK	Key lock configuration

A 5.3 General Commands

A 5.3.1 General

A 5.3.1.1 Help

```
HELP [<command>]
```

Help is displayed for a command. If no command is specified, general help information is displayed.

A 5.3.1.2 Controller Information

```
GETINFO
```

Controller data are queried. Output as per example below:

```
->GETINFO
Name:          IFC2422
Serial:        12345678
Option:        000
Article:       1234567
MAC-Address:   00-0C-12-01-30-01
Version:       001.035.056
Hardware-rev:  02
Boot-version   001.018
BuildID        400
->
```

Name: Name of the controller model / controller series

Serial: Controller serial number

Option: Controller option number

Article: Controller article number

MAC Address: Network adapter address

Version: Version of the booted software

Hardware-rev: Used hardware revision

Boot-version: Version of the boot loader

BuildID: Identification number of the generated software

A 5.3.1.3 Reply Type

```
ECHO ON|OFF
```

The reply type describes the structure of a command reply.

ECHO ON: Displays command name and command reply or an error message

ECHO OFF: Only displays command reply or an error message

A 5.3.1.4 Parameter Overview

```
PRINT ALL
```

no parameter: This command outputs a list of all setting parameters and its values.

- ALL : This command outputs a list of all setting parameters and its values, as well as information such as sensor table or GETINFO.

A 5.3.1.5 Synchronization

```
SYNC NONE | MASTER | SLAVE_SYNTRIG | SLAVE_TRIGIN
```

Setting the type of synchronization:

- NONE: No synchronization
- MASTER: The controller is master, i.e. it transmits synchronization pulses on the Sync/Trig output.
- SLAVE_SYNTRIG: Controller is slave and expects synchronization pulses from e.g. another IFC2421/2422/2465/2466 or a similar pulse source at the Sync/Trig input.
- SLAVE_TRIGIN: Controller is slave and expects synchronization pulses from a frequency generator at the TrigIn input.

Input	Characteristic
Sync/Trig	Differential
TrigIn	TTL / HTL

Sync/Trig may be an input or output, so you need to ensure that one of the controllers is defined as a master and the other one as a slave.

The TrigIn input is also used as trigger input for flank and level triggering.

A 5.3.1.6 Termination Resistor at Sync/Trig Input

```
TERMINATION OFF | ON
```

Switches off/on the termination resistor with 120 Ohm at the Sync/Trig synchronization input.

A 5.3.1.7 Booting the Sensor

```
RESET
```

The controller restarts.

A 5.3.1.8 Reset Counter

```
RESETCNT [TIMESTAMP] [MEASCNT]
```

The counter is reset after the selected trigger edge has arrived.

- TIMESTAMP: resets the time stamp
- MEASCNT: resets the measured value counter

A 5.3.2 Web interface

A 5.3.2.1 Language

```
LANGUAGE DE | EN
```

Select website language.

- DE: German language
- EN: English language

The website is displayed in the selected language.

A 5.3.2.2 Unit

```
UNIT MM | INCH
```

Changes the display of measured values on the websites.

The command has no effect on the ASCII interface and the command units.

- MM: Values are displayed in mm (default)
- INCH: Values are displayed in inch

A 5.3.3 User Level

A 5.3.3.1 Changing the User Level

```
LOGIN <Password>
```

Enter the password to switch to a different user level. The following user levels exist:

- USER: Read-only access to all elements + use of the web diagrams
- PROFESSIONAL: Read/write access to all elements

A 5.3.3.2 Changing to User Level

```
LOGOUT
```

Sets the user level to USER.

A 5.3.3.3 Querying the User Level

```
GETUSERLEVEL
```

Request the current user level.

For possible responses, see A 5.3.3.1, “Changing the user level”.

A 5.3.3.4 Defining a Standard User

```
STDUSER USER|PROFESSIONAL
```

Sets the standard user, who is logged in after system start.

A 5.3.3.5 Changing the Password

```
PASSWD <Old Password> <New Password> <New Password>
```

Changes the password for the PROFESSIONAL level. The default (preset) password is “000”.

The old password must be entered once, and the new password twice. If the new passwords do not match, an error message is displayed. Passwords are case sensitive. A password may only contain letters (A to Z) and numbers, but no special characters and no letters with accents or umlauts. The maximum length is 31 characters.

A 5.3.4 Sensor

A 5.3.4.1 Info about Calibration Tables

```
SENSORTABLE
```

```
->SENSORTABLE
Pos, Sensor name,      Range,      Serial
0, ifs-2405x,         3.000mm,   12345678
8, ifs-2405x,         10.000mm,  12345678
9, ifs-2405x,         3.000mm,   12345678
->
```

All available (learned) sensors are displayed.

A 5.3.4.2 Sensor Number

IFC2421 / IFC2465	IFC2422 / IFC2466
SENSORHEAD <Sensor-Position>	SENSORHEAD_CH01 <Sensor-Position>
	SENSORHEAD_CH02 <Sensor-Position>

Selects the current sensor from its position in the sensor table, see A 5.3.4.1.

Minimum 0, maximum 19.

A 5.3.4.3 Sensor Information

IFC2421 / IFC2465	IFC2422 / IFC2466
SENSORINFO	SENSORINFO_CH01
	SENSORINFO_CH02

Displays sensor data (name, measuring range and serial number).

```
->SENSORINFO
Position:          0
Name:             ifs-2405x
Measurement range: 3.000 mm
Serial:           12345678
->
```

A 5.3.4.4 Dark Reference

IFC2421 / IFC2465	IFC2422 / IFC2466
DARKCORR	DARKCORR_CH01
	DARKCORR_CH02

Dark referencing for the sensor selected with SENSORHEAD. The dark referencing is sensor-dependent and is stored in the controller per channel for each sensor.

A 5.3.4.5 Warning Threshold in the Event of Contamination

DARKCORRTHRES <Schwelle>

Threshold: Deviation (in %) of the intensity/exposure time from the stored value, above which a warning message will appear. Default setting: 50 %.

The warning threshold is set in % with one decimal.

A 5.3.4.6 LED

IFC2421 / IFC2465	IFC2422 / IFC2466
LED OFF ON	LED_CH01 ON OFF
	LED_CH02 ON OFF

Switches on/off the LED of the respective channel.

A 5.3.5 Triggering

A 5.3.5.1 Select Trigger Source

TRIGGERSOURCE NONE | SYNCTRIG | TRIGIN | SOFTWARE | ENCODER1 | ENCODER2

- NONE: No trigger source
- SYNCTRIG: Use Sync/Trig input
- TRIGIN: Use TrigIn input
- SOFTWARE: Triggering is caused by the TRIGGERSW command.
- ENCODER1: Encoder triggering of Encoder 1
- ENCODER2: Encoder triggering of Encoder 2

A 5.3.5.2 Output of Triggered Values, With/Without Averaging

TRIGGERAT INPUT | OUTPUT

INPUT: Triggering the measured value recording. When calculating the mean, measured values immediately before the trigger event are not included; instead older measured values are used, which were the output in previous trigger events.

OUTPUT: Triggering the measurement value output. When calculating the mean, measured values immediately before the trigger event are used.

Triggering of measured value recording is enabled as a factory default setting.

A 5.3.5.3 Trigger Type

```
TRIGGERMODE EDGE | PULSE
```

Defines the trigger type.

- PULSE: Level triggering
- EDGE: Edge triggering

A 5.3.5.4 Active Level Trigger Input

```
TRIGGERLEVEL HIGH | LOW
```

- HIGH: Edge triggering: Rising edge, level triggering: High-active
- LOW: Edge triggering: Falling edge, level triggering: Low-active

A 5.3.5.5 Software Trigger Pulse

```
TRIGGERSW
```

Creates a software trigger pulse, if SOFTWARE is selected as trigger source.

A 5.3.5.6 Number of Output Measurement Values

```
TRIGGERCOUNT NONE | INFINITE | <n>
```

- NONE: Stop triggering
- <n>: Number of measurement values which are displayed after a trigger impulse when edge triggering or software triggering.
- Infinite: Start infinite output of measurement values after a trigger impulse when edge triggering or software triggering.

A 5.3.5.7 Trigger Level Trigl

```
TRIGINLEVEL TTL | HTL
```

The level selection only applies for the TrigIn input. The Sync/Trig input expects a differential signal.

- TTL: Input expects TTL signal.
- HTL: Input expects HTL signal.

A 5.3.5.8 Step Size Encoder Triggering

```
TRIGGERENCSTEPSIZE [value of step size]
```

Sets the number of encoder steps, after which each one a measured value is output (min: 0 max: 231-1).

Measured values are output continuously between min. and max at 0.

A 5.3.5.9 Minimum Encoder Triggering

```
TRIGGERENCMIN [minimum value]
```

Sets the minimal encoder value, up to that is triggered (min: 0 max: 232-1).

A 5.3.5.10 Maximum Encoder Triggering

```
TRIGGERENCMAX [maximum value]
```

Sets the maximum encoder value, up to that is triggered (min: 0 max: 232-1).

A 5.3.6 Encoder

A 5.3.6.1 Encoder Interpolation Depth

```
ENCINTERPOL1 1|2|4
```

```
ENCINTERPOL2 1|2|4
```

Set the interpolation depth of each encoder input.

A 5.3.6.2 Effect of the Reference Track

```
ENCREF1 NONE|ONE|EVER
```

```
ENCREF2 NONE|ONE|EVER
```

Setting the effect of encoder reference track.

- NONE: Reference mark of the encoder has no effect.
- ONE: Unique setting (the encoder value is taken over at first reaching of reference marker position, [see A 5.3.6.3](#)).
- EVER: Setting at all marker positions (the encoder value is taken over at first reaching of reference marker position), [see A 5.3.6.3](#).

A 5.3.6.3 Encoder Value

```
ENCVALUE1 <Encoder value>
```

```
ENCVALUE2 <Encoder value>
```

Indicates, on which value the applicable encoder is to be set when reaching a reference marker position (or per software).

The encoder value can be set between 0 and $2^{32}-1$.

When setting the ENCVALUE, the algorithm for detecting the first reference marker position, [see A 5.3.6.2](#), is reset automatically.

A 5.3.6.4 Setting Encoder Value per Software

```
ENCSET 1|2
```

Setting the encoder value, [see A 5.3.6.3](#), in the specified encoder per software (only possible with ENCREF NONE, otherwise the command returns immediately without an error message).

A 5.3.6.5 Reset the Detection of the First Marker Position

```
ENCRESET 1|2
```

Reset the detection of the first reference marker position, [see A 5.3.6.2](#) (only possible with ENCREF ONE, otherwise the command returns immediately without an error message).

A 5.3.6.6 Maximum Encoder Value

```
ENCMAX1 <Encoder value>
```

```
ENCMAX2 <Encoder value>
```

Specifies the maximum value of the encoder, after which the encoder returns to 0. Can be used e.g. for rotary encoder without reference track.

The encoder value can be set between 0 and $2^{32}-1$.

A 5.3.7 Interfaces

A 5.3.7.1 Ethernet IP Settings

```
IPCONFIG DHCP | STATIC [<IPAddress> [<Netmask> [<Gateway>]]]
```

Set Ethernet interface.

DHCP: IP address and gateway are automatically requested by DHCP. System looks for a LinkLocal address after approx.. 2 minutes if no DHCP server is available.

STATIC: Set IP address, net mask and gateway in format xxx.xxx.xxx.xxx.

Values stay the same if no IP address, net mask, and gateway is typed in.

A 5.3.7.2 Setting for Ethernet Transmission of Measured Values

```
MEASTRANSFER NONE | SERVER/TCP [<PORT>] | (CLIENT/TCP | CLIENT/UDP  
 [<IPAdresse> [<Port>]])
```

The IFC242x can be operated as a server as well as a client for measurement output via Ethernet.

- NONE: No measurement transmission via Ethernet.
- SERVER/TCP: Controller provides a server for the typed in port, under which the measured values can be sent. This is only possible via TCP/IP.
- CLIENT/TCP: Controller sends measured values via TCP/IP connection oriented to server. The specifying of the IP address and server port are required, [see A 5.3.12.1](#).
- CLIENT/UDP: Controller sends measured values via UDP/IP connectionless to server. Therefore the IP address and the server port are specified.
- IPAddress: IP address of the server, to which measured values are sent when in client-mode, (only valid for CLIENT/TCP or CLIENT/UDP).
- Port: Port, to which the server gets assigned to in server-mode or to which the measured values are sent in client-mode (min: 1024, max: 65535).
- Commands are expected at port 23, the data port is factory-set to 1024.

A 5.3.7.3 Count of Measurements per Ethernet Frame

```
MEASCNT_ETH 0 | <count>
```

Set the maximum quantity of measurements per packet for Ethernet transfer.

- 0: Automatic assignment of frame count per packet
- count: Manual assignment of measurement count, range from 0 ... 350

A 5.3.7.4 Setting the RS422 Baud Rate

```
BAUDRATE <Baudrate>
```

Adjustable baud rates in examples:

9600, 115200, 230400, 460800, 691200, 921600, 2000000, 3000000, 4000000

A 5.3.7.5 Change Ethernet / EtherCAT

```
ETHERMODE ETHERNET|ETHERCAT
```

Select whether the controller starts with Ethernet or EtherCAT mode. The setting is active after save and reboot the controller only.

A 5.3.8 Parameter Management, Load / Save Settings

A 5.3.8.1 Safe / Load Connection Settings

```
BASICSETTINGS READ | STORE
```

- READ: Reads the connection settings from the controller flash.
- STORE: Saves the current connection settings from the controller RAM into the controller flash.

A 5.3.8.2 Show Changed Parameters

```
CHANGESETTINGS
```

Outputs all changed settings.

A 5.3.8.3 Export of Parameter Sets to PC

```
EXPORT (MEASSETTINGS <SetupName>) | BASICSETTINGS |  
MEASSETTINGS_ALL | MATERIALTABLE | ALL
```

Saving parameters in external device, e.g. PC.

The export file is output as readable JSON (JavaScript Object Notation).

- MEASSETTINGS <SetupName>: Export of indicated MeasSettings. Nothing is deleted before import.
- BASICSETTINGS: Export of current stored BasicSettings. BasicSettings are deleted before import.
- MEASSETTINGS_ALL: Export of all stored MeasSettings and initial setting. All MeasSettings are deleted before import.
- MATERIALTABLE: Export of stored material table. Material table is deleted before import.
- ALL: Export of all stored settings (Basic and Meas), the material table and all stored sensor data. Anything is deleted before import.

A 5.3.8.4 Import of Parameter Sets from PC

```
IMPORT [FORCE] [APPLY] <Daten>
```

Loading parameters from external device, e.g. PC.

The import file is a JSON file that was stored before during the export.

- FORCE: Overwriting Meassettings with the same name, otherwise an error message is displayed when the name is the same. When importing Meassettings or Basicsettings, Force must always specified.
- APPLY : Activates the settings after importing and reading the Initial Settings.

A 5.3.8.5 Default Settings

```
SETDEFAULT ALL | MEASSETTINGS | BASICSETTINGS | MATERIAL
```

Sets the default values (reset to factory setting), deletes the corresponding settings in the Flash.

- ALL: All setups are deleted and the default parameters are loaded. In addition, the current material table is overwritten with the standard material table.
- MEASSETTINGS: Settings for measurement task
- BASICSETTINGS: Basic settings such as e.g. IP, baud rate, language, unit.
- MATERIAL: Overwrites only the current material table with the standard material table.

A 5.3.8.6 Safe, Show, Delete Measurement Settings

MEASSETTINGS <Unterkommando> [<Name>]

Settings for measurement task transferring application-dependent measurement settings between controller RAM and controller Flash. Either the presets specified by the manufacturer or the user-specific settings are used. Each preset can be used as user-specific setting.

Subcommands:

PRESETMODE <mode>	Defines the preset dynamics.
<mode> = NONE STATIC BALANCED DYNAMIC	NONE means that there is no selection for a preset.
PRESETLIST	Lists all existing presets (names): "Name1" "Name2" "..."
READ <Name>	Loads a basic setting or a meassetting / preset from the controller Flash.
STORE <Name>	Stores a basic setting or a meassetting in the controller Flash. If no name is specified, the setting is saved under the current name.
DELETE <Name>	Deletes the indicated measurement setting from the controller Flash.
RENAME <NameOld> <NameNew> [FORCE]	Changes the name of a measurement setting in the controller Flash. FORCE overwrites an existing measurement setting.
LIST	Lists all stored measurement settings (names) "Name1" "Name2" "...". The order is defined by the internal slot numbers and not by the order as they were stored.
CURRENT	Output of all current meassettings / presets (name)
INITIAL AUTO	When starting the controller, the settings which were saved last or the first preset are loaded if no setups exist.
INITIAL <Name>	Loads the indicated measurement settings when starting the controller. Presets cannot be indicated.

A 5.3.9 Measurement

A 5.3.9.1 Number of Peaks

PEAKCOUNT <n>

Indicates the maximum number of peaks which should be evaluated.

- Distance measurement <n> = 1
- Thickness measurement <n> = 2
- Multilayer measurement <n> >2

A 5.3.9.2 Peak Selection

IFC2421 / IFC2465	IFC2422 / IFC2466
MEASPEAK F_L L_SL F_S H_SH	MEASPEAK_CH01 F_L L_SL F_S H_SH MEASPEAK_CH02 F_L L_SL F_S H_SH

Selection of the used peak for measurement.

Distance measurement		Thickness measurement	
F_L:	first peak	F_L:	first and last peak
L_SL:	last peak	L_SL:	second to last and last peak
F_S:	first peak	F_S:	first and second peak
H_SH:	highest peak	H_SH:	highest and second highest peak

A 5.3.9.3 Number of Peaks and Enabling/Disabling Refractive Correction

IFC2421 / IFC2465	IFC2422 / IFC2466
REFRACCORR on off	REFRACCORR_CH01 on off REFRACCORR_CH02 on off

- On: The refractive index correction is performed with the adjusted materials, default setting.
- Off: The refractive index 1.0 is expected for all layers.

A 5.3.9.4 Exposure Mode

IFC2421 / IFC2465	IFC2422 / IFC2466
SHUTTERMODE MEAS MANUAL 2TIMEALT 2TIMES	SHUTTERMODE_CH01 MEAS MANUAL 2TIMEALT 2TIMES SHUTTERMODE_CH02 MEAS MANUAL 2TIMEALT 2TIMES

- MEAS: Exposure time is controlled automatically, measuring rate is fixed. Recommended for measurements.
- MANUAL: User can select exposure time and measuring rate.
- 2TIMEALT: Mode with 2 manually defined exposure times that are used alternately for two distinctly differently high peaks (for thickness measurements). We recommend using this mode in particular, if the smaller peak disappears or the higher peak overshoots.
- 2TIMES: Fastest mode with two manually preset exposure times. The more suitable time is automatically selected. Recommended to measure distances for fast changing surface properties, such as mirrored or anti-glare glass.

A 5.3.9.5 Measuring Rate

MEASRATE <Messrate>

Specifies the measuring rate in kHz:

IFC2421/2422: range 0.100 ... 6.500;

IFC2465/2466: range 0.100 ... 30.000.

A maximum of three decimal places may be specified, e. g. 0.100 for 0.1 kHz.

A 5.3.9.6 Exposure Time

IFC2421 / IFC2465	IFC2422 / IFC2466
SHUTTER <Exposure Time1> [<Exposure Time2>]	SHUTTER_CH01 <Exposure Time1> [<Exposure Time2>] SHUTTER_CH02 <Exposure Time1> [<Exposure Time2>]

Specifies the exposure times for the manual and the two-times exposure mode.

The exposure time is indicated in μs . Range: 1 μs ... 10000 μs (IFC242x) or 3 μs ... 10000 μs (IFC246x).

The exposure time is processed with three decimal places. The minimum increment is 0.1 μs .

A 5.3.9.7 Masking the Evaluation Range

IFC2421 / IFC2465	IFC2422 / IFC2466
ROI <Start> <Ende>	ROI_CH01 <Start> <Ende> ROI_CH02 <Start> <Ende>

Setting the evaluating range for the „Range of interest“ of the respective channel. Start and end must be between 0 and 511. The figure is given in pixels. The start value must be less than the end value.

A 5.3.9.8 Peak Detection Threshold

IFC2421 / IFC2465	IFC2422 / IFC2466
MIN_THRESHOLD <n>	MIN_THRESHOLD_CH01 <n> MIN_THRESHOLD_CH02 <n>

Sets the minimum detection threshold. A peak must be above this threshold in order to be detected as peak.

The value is entered in % and refers to the dark corrected signal.

A 5.3.9.9 Peak Modulation

IFC2421 / IFC2465	IFC2422 / IFC2466
PEAK_MODULATION <n>	PEAK_MODULATION_CH01 <n> PEAK_MODULATION_CH02 <n>

Indicates the magnitude of the modulation in order to separate interleaved peaks. With 100 % there is no peak separation and with 0 % (default setting) all peaks are separated.

This is how peak artifacts can be removed or are not regarded as individual peaks.

A 5.3.10 Material Data Base

A 5.3.10.1 Material Table

MATERIALTABLE

Output of material table that is stored in the controller.

```

->MATERIALTABLE
                                     Refraction index
Pos,  Name,      nF at 486nm,      nd at 587nm,  nC at 656nm,  vd      Description
0     Vakuum,    1.000000,      1.000000,    1.000000,    0.000000    Vacuum; air (approximately)
1     Wasser,    1.337121,      1.333044,    1.331152,    0.000000
1     Ethanol,   1.361400,      1.361400,    1.361400,    0.000000
7     PC,        1.599439,      1.585470,    1.579864,    0.000000    Polycarbonate
8     Quarzglas, 1.463126,      1.458464,    1.456367,    0.000000    Silica, Fused Silica
9     BK7,       1.522380,      1.516800,    1.514320,    0.000000    Crown glass
->

```

A 5.3.10.2 Select Material

MATERIAL <Materialname>

IFC2421 / IFC2465	IFC2422 / IFC2466
MATERIAL <Materialname>	MATERIAL_CH01 <Materialname>
	MATERIAL_CH02 <Materialname>

Change of material between displacement 1 and 2 for each particular channel.

Material name must be typed in with a blank. The command supports case sensitive inputs. The maximum length of material name is 30 characters.

A 5.3.10.3 Display Material Properties

MATERIALINFO

IFC2421 / IFC2465	IFC2422 / IFC2466
MATERIALINFO [<layer>]	MATERIALINFO_CH01 [<layer>]
	MATERIALINFO_CH02 [<layer>]

Output of material properties of the selected layer. Layer 1 is between distance 1 and 2, layer 2 is between distance 2 and 3 etc. If no parameters are specified, the data for layer 1 are output.

Example:

```

->MATERIALINFO
Name:                               BK7
Description:                         Crown glass
Refraction index nF at 486nm:        1.522380
Refraction index nd at 587nm:        1.516800
Refraction index nC at 656nm:        1.514320
Abbe value vd:                       0.000000
->

```

A 5.3.10.4 Edit Material Table

```
MATERIALEDIT <Name> <Description> (NX <nF> <nd> <nC>) | (ABBE <nd>
<Abbezahl>)
```

Add or edit material for multilayer measurement, [see A 5.3.10.6](#).

- Name: Name of material (Length: max. 30 characters)
- Description: Description of material (Length: max. 62 characters)
- NX: Material is characterized by three refractive indices
- ABBE: Material is characterized by a refractive index and the Abbe number
- nF: Refractive index nF at 486 nm (min: 1.0, max: 4.0)
- nd: Refractive index nd at 587 nm (min: 1.0, max: 4.0)
- nC: Refractive index nC at 656 nm (min: 1.0, max: 4.0)
- Abbe number: Abbe number vd (min: 10.0, max: 200.0)

The refractive indices and Abbe number are processed with six decimal places.

If the material name is already assigned, this material is being edited. Otherwise a new material is applied.

There is a maximum of 20 materials.

A 5.3.10.5 Delete a Material

```
MATERIALDELETE <Name>
```

Delete a material

- Name: Name of material (Length: max. 30 characters)

A 5.3.10.6 Material Settings Multilayer Measurement

IFC2421 / IFC2465	IFC2422 / IFC2466
MATERIALMP [<Material1> [<Material2>[<Material3> [<Material4>[<Material5>]]]]]	MATERIALMP_CH01 [<Material1> [<Material2>[<Material3> [<Material4>[<Material5>]]]]]
	MATERIALMP_CH02 [[<Material1> [<Material2>[<Material3> [<Material4>[<Material5>]]]]]

Displaying and setting the materials for the layers between the peaks 1 up to 6.

The existing material is maintained with input from „“.

A 5.3.11 Measurement Value Processing

A 5.3.11.1 Spike Correction

IFC2421 / IFC2465	IFC2422 / IFC2466
SPIKECORR [ON OFF][[<Number of evaluated measured values>][[<Tolerance range in mm>][<Number of corrected values>]]]	SPIKECORR_CH01 [ON OFF][[<Number of evaluated measured values>][[<Tolerance range>][<Number of corrected values>]]] SPIKECORR_CH02 [ON OFF][[<Number of evaluated measured values>][[<Tolerance range in mm>][<Number of corrected values>]]]

Activate and parametrize spike correction. Spike correction is not enabled in the factory default settings.

	Factory settings	Min	Max
Number of evaluated measurements	3	1	10
Tolerance range in mm	0.1000000	0.0000000	100.0000000
Number of corrected values	1	1	100

The tolerance range is set in mm with seven decimals.

A 5.3.11.2 Statistics Calculation

```
STATISTIC <signal> RESET
```

Resets an individual statistics.

- <signal>: Statistical data minimum, maximum or peak-peak

A 5.3.11.3 List of Signals for the Statistics

```
META_STATISTIC
```

Displays a list with the active statistical signals.

These signals were defined under STATISTICSIGNAL.

A 5.3.11.4 Reset the Statistics Calculation

```
RESETSTATISTIC
```

Reset the statistics (of the current min and max value).

A 5.3.11.5 Selection of a Signal for the Statistics

```
STATISTICSIGNAL <signal>
```

For this selected signal the statistics are generated. A list with possible signals can be found with the META_STATISTICSIGNAL command.

New signals are created which can then be output via the interfaces.

- <signal>_MIN --> Minimum signal
- <signal>_MAX --> Maximum signal
- <signal>_PEAK --> <signal>_max - <signal>_min

A 5.3.11.6 List of Possible Signal for the Statistics to be Selected

```
META_STATISTICSIGNAL
```

Lists all possible signals that can be included in the statistics.

A 5.3.11.7 List of Signals which can be Parameterized

```
META_MASTERSIGNAL
```

Lists all possible signals which can be used for mastering.

A 5.3.11.8 Master Signal Parameterization

```
MASTERSIGNAL [<signal>] <master value> | NONE
```

Defines the signal to be mastered. The `NONE` parameter resets the signal.

- `<signal>`: Selecting a specific measured or calculated signal on which the master value should be set
- `<master value>` Master value in mm, value range: -2147.0 ... 2147.0

A 5.3.11.9 List of Possible Signals for Mastering

```
META_MASTER
```

Lists all defined master signals from the `MASTERSIGNAL` command and can be used with the `MASTER` command.

A 5.3.11.10 Masters / Zero

```
MASTER [<signal>]
```

```
MASTER ALL|<signal> SET|RESET
```

The `MASTER` is not channel specific. Up to 10 master signals are in the controller which can be applied on all internally determined values and calculated values.

This command sets/resets the mastering process for the corresponding signal.

- `ALL`: Use all signals for mastering
- `<signal>`: `<signal>`: Use a specific measured or calculated signal for the mastering process
- `SET|RESET`: Start or stop the function

If the master value is 0, the mastering function has the same functionality as the zero setting.

The master command waits for a maximum of 2 seconds for the next measurement value and uses this as master value. If no value is measured within this time, e.g. in case of external triggering, the command returns with the error „E32 Timeout“. The master value is processed with six decimal places.

A 5.3.11.11 Mastering Example

This example is based on the `Two-sided thickness measurement` preset in the controller. The commands are executed with the Telnet program, no variables defined.

```
->o 169.254.168.150
```

```

_____
/   _  \
/|  ||  \
| |  ||  |
| |  ||  |
\ |__| |__ /
 \      /

```

Connected with the MICRO-OPTRONIC terminal server. Your IP 169.254.168.2, your local port number 54532 and you are connected to port number 23

<p>->META_MASTERSIGNAL META_MASTERSIGNAL 01DIST1 02DIST1 Thick</p>	<p>// Lists all variables which can be mastered</p>			
<p>->META_MASTER META_MASTER NONE</p>	<p>// Lists all variables which are assigned with a master value</p>			
<p>->MASTERSIGNAL Thick 16.5 ->MASTERSIGNAL 01DIST1 10</p>	<p>// Setting Variable Thick to 16.5 // Setting Variable 01DIST1 to 10</p>			
<p>->META_MASTER META_MASTER 01DIST1 Thick</p>	<p>// Lists all variables which are assigned with a master value; the variables 01DIST1 and Thick are now assigned with a master value</p>			
<p>->MASTER ALL MASTER Thick INACTIVE MASTER 01DIST1 INACTIVE MASTER NONE MASTER NONE ... MASTER NONE MASTER NONE MASTER NONE MASTER NONE</p>	<p>// Lists the 10 possible variables and shows their status</p> <table border="1" data-bbox="879 882 1414 943"> <tr> <td>01DIST1 3.97188 mm</td> <td>02DIST1 4.07372 mm</td> <td>Thick 1.96904 mm</td> </tr> </table>	01DIST1 3.97188 mm	02DIST1 4.07372 mm	Thick 1.96904 mm
01DIST1 3.97188 mm	02DIST1 4.07372 mm	Thick 1.96904 mm		
<p>->MASTER ALL SET</p>	<p>// Triggers a master measurement for all assigned variables</p> <table border="1" data-bbox="879 1077 1414 1137"> <tr> <td>01DIST1 10.03861 mm</td> <td>02DIST1 2.22141 mm</td> <td>Thick 16.00510 mm</td> </tr> </table>	01DIST1 10.03861 mm	02DIST1 2.22141 mm	Thick 16.00510 mm
01DIST1 10.03861 mm	02DIST1 2.22141 mm	Thick 16.00510 mm		
<p>->MASTER 01DIST1 RESET</p>	<p>// Resets the offset (master value) for the variable 01DIST1</p> <table border="1" data-bbox="879 1234 1414 1294"> <tr> <td>01DIST1 3.68267 mm</td> <td>02DIST1 3.53795 mm</td> <td>Thick 16.14950 mm</td> </tr> </table>	01DIST1 3.68267 mm	02DIST1 3.53795 mm	Thick 16.14950 mm
01DIST1 3.68267 mm	02DIST1 3.53795 mm	Thick 16.14950 mm		
<p>->MASTER ALL MASTER Thick ACTIVE MASTER 01DIST1 INACTIVE MASTER NONE MASTER NONE ... MASTER NONE MASTER NONE MASTER NONE MASTER NONE</p>				
<p>->MASTER Thick RESET</p>	<p>// Resets the offset (master value) for the variable Thick</p> <table border="1" data-bbox="879 1832 1414 1892"> <tr> <td>01DIST1 3.65359 mm</td> <td>02DIST1 3.56958 mm</td> <td>Thick 2.77601 mm</td> </tr> </table>	01DIST1 3.65359 mm	02DIST1 3.56958 mm	Thick 2.77601 mm
01DIST1 3.65359 mm	02DIST1 3.56958 mm	Thick 2.77601 mm		
<p>->MASTERSIGNAL 01DIST1 NONE ->MASTERSIGNAL Thick NONE</p>	<p>// The variable 01DIST1 is deleted // The variable Thick is deleted</p>			
<p>->MASTER ALL MASTER NONE ... MASTER NONE</p>	<p>// No variable on which a master measurement could be applied</p>			

A 5.3.11.12 Channel Selection

```

COMP [<channel> [<id>]]
COMP <channel> <id> MEDIAN <signal> <median data count>
COMP <channel> <id> MOVING <signal> <moving data count>
COMP <channel> <id> RECURSIVE <signal> <recursive data count>
COMP <channel> <id> CALC <factor1> <signal> <factor2> <signal>
<offset> <name>
COMP <channel> <id> THICKNESS <signal> <signal> <name>
COMP <channel> <id> COPY <signal> <name>
COMP <channel> <id> NONE

```

This command defines all channel-specific and controller-specific calculations.

- <channel> CH01|CH02|SYS *Channel selection*
 - <id> 1...10 *Number of calculation block*
 - <signal> *Measurement signal; query the available signals with the META_COMP command*

 - <median data count> 3|5|7|9 *Averaging depth Median*
 - <moving data count> 2|4|8|16|32|64|128|256|512|1024|2048|4096 *Averaging depth of moving average*
 - <recursive data count> 2 ... 32000 *Averaging depth of recursive average*
 - <factor1>, <factor2> -32768,0 ... 32767,0 *Multiplication factor*
 - <offset> -2147,0 ... 2147,0 *Correction value in mm*
 - <name> *Name of calculation block; min. length 2 characters, max. length 15 characters
Permitted characters a-zA-Z0-9, the name must begin with a letter.*
- Command names are not permitted, e.g. STATISTIC, MASTER, CALC, NONE, ALL.*

The COMP command enables you to create, modify and delete calculation blocks.

Functions:

- MEDIAN, MOVING and RECURSIVE: averaging functions
- CALC: calculation function based on formula
(<factor1> * <signal>) + (<factor2> * <signal>) + <offset>
- Thickness: Thickness calculation based on formula (<signal B>) - <signal A> on condition that signal B is larger than signal A.
- COPY: Duplicates a signal; this effect can also be achieved with the CALC command, e.g. with (1 * <signal>) + (0 * <signal>) + 0
- NONE: Deletes a calculation block

A 5.3.11.13 List of possible calculation signals

```
META_COMP
```

Lists all possible signals which can be used in the calculation.

A 5.3.11.14 Two-Point Scaling Data Outputs

```
SYSSIGNALRANGE <Start of range> <End of range>
```

The determined values from the calculation can be larger than the values displayed by the controller This command stipulates the range of values.

Default is 0 to 10 mm.

A 5.3.12 Data Output

A 5.3.12.1 Selection of Digital Output

OUTPUT NONE | RS422 | ETHERNET | ANALOG | ERRORROUT

- NONE: No measurement value output
- RS422: Output of measurement values via RS422
- ETHERNET: Output of measurement values via Ethernet
- ANALOG: Output of measurement values via analog output
- ERRORROUT: Error or status information about the switching outputs

Command starts the measurement value output. If not yet done, connect the controller now to the measurement server.

A 5.3.12.2 Data output Rate

OUTREDUCEDEVICE NONE | [RS422] [ANALOG] [ETHERNET]

Reduces the measured value output via the indicated interfaces.

- NONE: No reduction of measurement value output
- RS422: Reduction of measurement value output via RS422
- ETHERNET: Reduction of measurement value output via Ethernet

A 5.3.12.3 Reduction Counter of Measurement Value Output

OUTREDUCECOUNT <Number>

Reduction counter of measurement value output.

Only every n-th measured value is output. The other measurement values are rejected.

- Number: 1...3000000 (1 means all frames)

A 5.3.12.4 Error Processing

OUTHOLD NONE | INFINITE | <Number>

Setting the behavior of the measurement value output in case of error.

- NONE: No holding the last measurement value, output of error value
- INFINITE: Infinite holding of the last measurement value
- Number: Holding the last measurement value on the number of measuring cycles; then an error value (maximum of 1024) is output.

A 5.3.13 Select Measurement Values to be Output

A 5.3.13.1 General

Setting the values to be output via the RS422 and Ethernet interface.

Limiting the data volume via RS422 depends on the measurement frequency and the baud rate.

The maximum output rate via the Ethernet interface depends on the number of output values.

Any distances and differences can be selected for the output in the multilayer measurement mode. All measurement values required for the difference calculations are output in addition to the Ethernet measuring value transmission.

Via the Ethernet interface always the displacement 1 and in case of thickness measurement the displacement 1 and 2 and the difference 1-2 is output.

A 5.3.13.2 Data selection for Ethernet

```
OUT_ETH <signal1> <signal2> ... <signalN>
```

Describes which data are output via these interfaces.

A 5.3.13.3 List of Possible Ethernet Signals

```
META_OUT_ETH
```

List of possible data for Ethernet.

A 5.3.13.4 List of Selected Signals, Transfer Sequence via Ethernet

```
GETOUTINFO_ETH
```

Indicates the signal sequence via these interfaces.

A 5.3.13.5 Data selection for RS422

```
OUT_RS422
```

Describes which data are output via these interfaces.

A 5.3.13.6 List of Possible RS422 Signals

```
META_OUT_RS422
```

List of possible data for RS422.

A 5.3.13.7 List of Selected Signals, Transfer Sequence via RS422

```
GETOUTINFO_RS422
```

Indicates the signal sequence via these interfaces.

A 5.3.14 Switching Outputs

A 5.3.14.1 Error Switching Outputs

```
ERROROUT1 NONE|ER1|ER2|ER12|LI1|LI2|LI12
```

```
ERROROUT2 NONE|ER1|ER2|ER12|LI1|LI2|LI12
```

Setting the error switching outputs.

- NONE: No output on the error switching outputs
- ER1: Switching output is switched in case of intensity error
- ER2: Switching output is switched in case of a measured value outside of the measuring range
- ER12: Switching output is switched in case of an intensity error or a measured value outside of the measuring range
- LI1: Switching output is switched in case of deceeding the lower limit
- LI2: Switching output is switched in case of exceeding the upper limit
- LI12: Switching output is switched in case of deceeding the lower limit or exceeding the upper limit

A 5.3.14.2 Setting the Signal to be Evaluated

```
ERRORLIMITSIGNALn
```

Selecting the signal which should be used for the limit value consideration.

A 5.3.14.3 List of Possible Signals for Error Output

```
META_ERRORLIMITSIGNAL
```

List with all possible signals that could have effects on the error outputs.

A 5.3.14.4 Setting Limit Values

```
ERRORLIMITCOMPARETOn [LOWER | UPPER | BOTH]
```

Indicates if the output should switch to active with

- LOWER --> shortfall
- UPPER --> exceedance
- BOTH --> shortfall and exceedance

A 5.3.14.5 Setting Value

```
ERRORLIMITVALUESn
```

Sets the values for the Lower and Upper limit values.

A 5.3.14.6 Switching Behavior of Error Outputs

```
ERRORLEVELOUT1 PNP|NPN|PUSHPULL|PUSHPULLNEG
```

```
ERRORLEVELOUT2 PNP|NPN|PUSHPULL|PUSHPULLNEG
```

Switching behavior of error outputs Error 1 and Error 2.

- PNP: Switching output is High with error and open without error
- NPN: Switching output is Low with error and open without error
- PUSHPULL: Switching output is High with error and Low without error
- PUSHPULLNEG: Switching output is Low with error and High without error

A 5.3.15 Analog Output

A 5.3.15.1 Data Selection

ANALOGOUT Signal

Selection of the signal which should be output via the analog output. As parameter, the signal is indicated. A list of possible signals can be seen with META_ANALOGOUT, see A 5.3.15.2.

A 5.3.15.2 List of Possible Signals for Analog Output

META_ANALOGOUT

Lists all signals that can be sent to the analog output.

A 5.3.15.3 Output range

ANALOGRANGE 0-5V | 0-10V | 4-20mA

- 0 - 5 V: The analog output outputs a voltage of 0 to 5 volts.
- 0 - 10 V: The analog output outputs a voltage of 0 to 10 volts.
- 4 - 20 mA: The analog output outputs a current of 4 to 20 mA.

A 5.3.15.4 Setting the Scaling of DAC

ANALOGSCALEMODE STANDARD | TWOPOINT

Decides between either a one-point or two-point scaling of the analog output.

- STANDARD --> One-point scaling
- TWOPOINT --> Two-point scaling

The default scaling is for displacements $-MR/2$ up to $MR/2$ and for thickness measurement on 0 up to 2 MR (MR=Measuring range).

The minimum and maximum measured value is to output in millimeters. The available output range of the analog output is then spread between the minimum and maximum measured value. The minimum and maximum measured value must be between -2147.0 and 2147.0.

The minimum and maximum measured value is processed with three decimal places.

A 5.3.15.5 Setting the Scaling Range

ANALOGSCALERANGE <lower limit> < upper limit>

Indicates the limits for two-point scaling.

A 5.3.16 Key Functions

A 5.3.16.1 Multifunction Button

IFC2421 / IFC2465	IFC2422 / IFC2466
<p>KEYFUNC1 NONE DARKCORR MASTERSET MASTERRESET LED</p> <p>KEYFUNC2 NONE DARKCORR MASTERSET MASTERRESET LED</p>	<p>KEYFUNC1 NONE DARKCORR DARKCORR_CH01 DARKCORR_CH02 MASTER MASTERRESET LED LED_CH01 LED_CH02</p> <p>KEYFUNC2 NONE DARKCORR DARKCORR_CH01 DARKCORR_CH02 MASTER MASTERRESET LED LED_CH01 LED_CH02</p>
Time range 0 ... 2 s	
<ul style="list-style-type: none"> - NONE: No function - DARKCORR: Dark reference, see DARKCORR command - MASTERSET: Activates the master function, see 6.2.4. Applies for all signals which were selected with the KEYMASTERSIGNALSELECT command. - MASTERRESET: Deactivates the master function. - LED: Switches the sensor light source alternately on/off. 	<ul style="list-style-type: none"> - NONE: No function - DARKCORR_CH01: Dark reference for channel/sensor 1. - DARKCORR_CH02: Dark reference for channel/sensor 2. - MASTERSET: Activates the master function, see 6.2.4. Applies for all signals which were selected with the KEYMASTERSIGNALSELECT command. - MASTERRESET: Deactivates the master function. - LED_CH01: Switches the sensor 1 light source alternately on/off. - LED_CH02: LED: Switches the sensor 2 light source alternately on/off.
Time range 2 ... 5 s	
<ul style="list-style-type: none"> - NONE: No function - DARKCORR: Dark reference, see DARKCORR command - MASTERSET: Activates the master function, see 6.2.4. Applies for all signals which were selected with the KEYMASTERSIGNALSELECT command. - MASTERRESET: Deactivates the master function. - LED: Switches the sensor light source alternately on/off. 	<ul style="list-style-type: none"> - NONE: No function - DARKCORR_CH01: Dark reference for channel/sensor 1. - DARKCORR_CH02: Dark reference for channel/sensor 2. - MASTERSET: Activates the master function, see 6.2.4. Applies for all signals which were selected with the KEYMASTERSIGNALSELECT command. - MASTERRESET: Deactivates the master function. - LED_CH01: Switches the sensor 1 light source alternately on/off. - LED_CH02: LED: Switches the sensor 2 light source alternately on/off.

A 5.3.16.2 Signal Selection for Mastering with Multifunction Button

```
KEYMASTERSIGNALSELECT ALL | <signal> [<signal2> [...]]
```

Selecting the measurement signals which should be mastered by key actuation. The available signals can be queried with the META_MASTER command. MASTER SIGNAL configures the signals that can be mastered.

A 5.3.16.3 Key Lock

```
KEYLOCK NONE | ACTIVE | (AUTO [<value>])
```

Key lock configuration

- NONE: Key is active, no key lock
- ACTIVE: Key lock is activated immediately after restart
- AUTO: Key lock is activated only <time> seconds after restart

A 5.4 Measured Value Format

A 5.4.1 Structure

The structure of measurement frames, [see A 5.5.2.2](#), depends on the selected measurement values or the selected preset. See below for a summary of commands which enable you to query the available measurement values via Ethernet or RS422.

Chap. A 5.3.13.2	OUT_ETH	Data selection for Ethernet
Chap. A 5.3.13.3	META_OUT_ETH	List of Possible Ethernet Signals
Chap. A 5.3.13.4	GETOUTINFO_ETH	List of Selected Signals, Transfer Sequence via Ethernet
Chap. A 5.3.13.5	OUT_RS422	Data selection for RS422
Chap. A 5.3.13.6	META_OUT_RS422	List of Possible RS422 Signals
Chap. A 5.3.13.7	GETOUTINFO_RS422	List of Selected Signals, Transfer Sequence via RS422

Example for the structure of a data block, query with Telnet:

Preset Standard matt ->META_OUT_ETH META_OUT_ETH 01RAW 01DARK 01LIGHT 02RAW 02DARK 02LIGHT 01SHUTTER 01ENCODER1 01ENCODER2 01INTENSITY 01DIST1 02SHUTTER 02ENCODER1 02ENCODER2 02INTENSITY 02DIST1 MEASRATE TRIGTIMEDIFF TIMESTAMP TIMESTAMP_HIGH TIMESTAMP_LOW COUNTER	Preset One-sided thickness measurement ->META_OUT_ETH META_OUT_ETH 01RAW 01DARK 01LIGHT 02RAW 02DARK 02LIGHT 01SHUTTER 01ENCODER1 01ENCODER2 01INTENSITY 01DIST1 01DIST2 02SHUTTER 02ENCODER1 02ENCODER2 02INTENSITY 02DIST1 02DIST2 MEASRATE TRIGTIMEDIFF TIMESTAMP TIMESTAMP_HIGH TIMESTAMP_LOW COUNTER Ch- 01Thick12 Ch02Thick12 ->
->GETOUTINFO_ETH GETOUTINFO_ETH 01SHUTTER 01INTENSITY1 01DIST1 02SHUTTER 02INTENSITY1 02DIST1 ->	->GETOUTINFO_ETH GETOUTINFO_ETH 01SHUTTER 01INTENSITY1 01DIST1 01INTENSITY2 01DIST2 02SHUTTER 02INTENSITY1 02DIST1 02INTENSITY2 02DIST2 Ch01Thick12 Ch02Thick12 ->

A measurement value frame is dynamically structured, i.e. values not selected are not transferred.

A 5.4.2 Video Signal

Video signals, which were calculated in signal processing, can be transmitted. A video signal consists of 512 pixel. A pixel is described by a 16-bit word. The used value range is 0 ...16383.

There are five available video signals:

- Raw signal
- Dark-corrected signal
- Light source corrected signal

The dark value table and light value table can be queried with the commands `DARKCORR_PRINT` or `LIGHTCORR_PRINT`.

Pixel 0	Pixel 1	..	Pixel 511
Raw signal, 16 bit	Raw signal	..	Raw signal
Dark corrected signal, 16 bit	Dark corrected signal	..	Dark corrected signal
Light source corrected signal, 16 bit	Light source corrected signal	..	Light source corrected signal

Fig. 87 Data structure of video signals

A 5.4.3 Exposure Time

The data word to the exposure time is 32-bit wide during transmission via Ethernet. The resolution is 100 ns.

The output of the exposure time via the RS422 interface is effected by a resolution of 100 ns. No conversion is required for IFC2421/2422 controllers, but the output value must be divided by 9 for IFC2465/2466 controllers.

For that the data word is 18 bits wide.

A 5.4.4 Encoder

The encoder values for transmission can be selected individually. A 32 bit data word (unsigned integer) with the encoder position is output via Ethernet. Only the lower 18 bits of the encoder values are transmitted by the transmission via RS422.

A 5.4.5 Measured Value Counter

The transmission of the measured value counter via Ethernet is effected as 32 bit value (unsigned integer). On the RS422 interface, only the lower 18 bits of the profile counter are transmitted.

A 5.4.6 Time Stamp

Intrasystem the resolution of time stamp is 1 μ s. For the Ethernet transfer a 32 bit data word (unsigned integer) with the intrasystem resolution is output.

For the transmission via RS422, two 18 bit data words are provided (`TIMESTAMP_LOW` and `TIMESTAMP_HIGH`).

A 5.4.7 Measurement Data (Displacements and Intensities)

An intensity (if selected) and a measurement value are transmitted for each selected displacement. For the Ethernet transmission 32 bit for each are used. The assembly of the data word for the intensity is shown in the following table, see Fig. 88. The resolution of the displacement values is 1 nm on the Ethernet line, the output is signed. The format for RS422 is described, see A 5.5.1.

Bit position	Description
0 - 10	Intensity of peak (100 % comply with 1024)
11 - 15	Reserved
16 - 29	Maximum of peak (from dark corrected signal)
30 - 31	Reserved

Fig. 88 Table Intensity

During transmission via RS422 only the 'Intensity of peak' is transmitted (the lower 10 bit).

The intensity value is determined using the following calculation rule:

$$\text{Intensität} = \frac{\text{Max_dark}}{\text{Sättigung} - \text{Max_raw} + \text{Max_dark}}$$

- Max_dark refers to the dark corrected signal.
- Max_raw refers to the raw signal.
- Saturation refers to the AD range ($2^{14}-1$).

A 5.4.8 Trigger Time Difference

The trigger time difference is output via Ethernet as an unsigned 32 bit integer or via RS422 as an unsigned 18 bit integer with a resolution of 100 ns.

Range 0....100000

A 5.4.9 Differences (thicknesses)

Calculated differences between two distances have the same format as the distances.

First, the selected differences between distance 1 and the other distances are output, then those of distances 2, ...

The difference values are provided as 32 bit signed integer with 1 nm resolution. Please refer to, see A 5.5.1 for the RS422 format.

A 5.4.10 Statistical values

Statistical values have the same format as the distances.

The transmission sequence (if selected) starts with minimum, then maximum and peak-to-peak.

Statistical values are provided as 32 bit signed integer with 1 nm resolution or in the format for the RS422 interface.

A 5.4.11 Peaksymmetrie

The peak symmetry value is output via Ethernet as a 32-bit fixed-point number (signed integer) with 18-bit decimal places or via RS422 as an 18-bit signed integer with 4-bit decimal places.

A 5.5 Measurement Data Format

A 5.5.1 Data Format RS422 Interface

A 5.5.1.1 Video Data

<Preamble>	<Size>	<video data>	<End>
Start recognition 64 Bit 0xFFFFF00FFFF000000	Size 32 Bit Size of video data in Byte	16 Bit unsigned	End recognition 32 Bit 0xFEFE0000

Fig. 89 Structure of a video frame

Data structure, see Fig. 87.

A 5.5.1.2 Measurements

The output of distance measured values and other measured values via RS422 requires subsequent conversion into the relevant unit. Die Messwertdaten, sofern angefordert, folgen immer einem Videoframe.

Output value 1:

	Preamble		Data bits					
L-Byte	0	0	D5	D4	D3	D2	D1	D0
M-Byte	0	1	D11	D10	D9	D8	D7	D6
H-Byte	1	0	D17	D16	D15	D14	D13	D12

Output value 2 ... 32:

	Preamble		Data bits					
L-Byte	0	0	D5	D4	D3	D2	D1	D0
M-Byte	0	1	D11	D10	D9	D8	D7	D6
H-Byte	1	1	D17	D16	D15	D14	D13	D12

Value range for the displacement and thickness measurement:

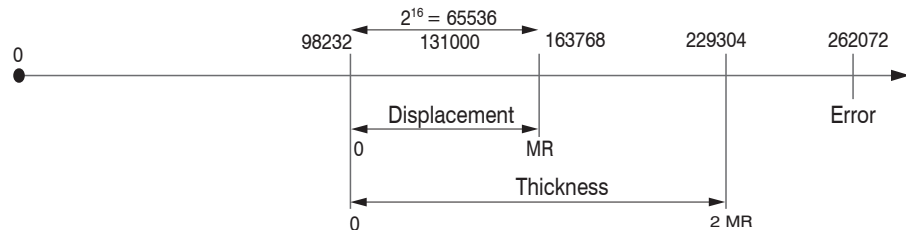

131000 = Midrange for the displacement measurement

MR = Measuring range

The linearized measurement values can be converted in millimeters using the subsequent formula:

$$x = \frac{(d_{\text{OUT}} - 98232) * \text{MR}}{65536}$$

x = Displacement / Thickness in mm

d_{OUT} = digital output value

MR = Measuring range in mm

All values greater than 262072 are error values and are defined as follows:

Error code	Description
262073	Scaling error RS422 interface underflow
262074	Scaling errors RS422 interface overflow
262075	Too much data for selected baud rate ¹⁾
262076	There is no peak present.
262077	Peak is located in front of the measuring range (MR)
262078	Peak is located behind the measuring range (MR)
262079	Measuring value cannot be calculated.

The restrictions for all other data outputs except the measurement value data are defined in the relevant Chapters, [see 5](#).

1) This error occurs when more data are to be output as with selected baud rate for the selected measuring can be transmitted. To remove the error, there are the following possibilities:

- Increase the baud rate, [see A 5.3.7.4](#)
- Decrease measuring rate, [see A 5.3.9.5](#)
- Decrease data; if 2 data words have been selected, then reduce to a data word, [see A 5.3.13](#)
- Reduce output data rate, [see A 5.3.12.2](#)

A 5.5.2 Measurement Data Transmission to a Server via Ethernet

A 5.5.2.1 General

During the measurement data transmission to a measurement value server the sensor transmits each measurement value to the measurement value server or to the connected client after successful connection (TCP or UDP). Therefore no explicit requirement is necessary.

Any distances and additional information to be transmitted that are logged at one point in time are combined to form a value frame. Different measurement value frames are combined to a measurement value block, which contains a header and fits a TCP/IP or UDP/IP packet. The header is mandatory at the start of a UDP or TCP packet. In case of changes of the transferred data or the frame rate a new header is automatically sent.

All measurement data and the header are transmitted in the little Endian format.

Preamble (32 Bit)
Order number (32 Bit)
Serial number (32 Bit)
Length video data (32 Bit)
Length measurement data (32 Bit)
Frame number (32 Bit)
Counter (32 Bit)

The structure of a header for video and measurement data transfer is the same.

Header entry	Description
Preamble	uint32_t - 0x41544144 "DATA"
Order number	
Serial number	
Length video data	[Byte]
Length measurement data	[Byte]
Frame number	Number of frames, that cover this header. With video output, the field for the number of measurement data frames is set to one in the packet.
Counter	Counter on the number of processed measurement values

Example: The data encoder 1, distance and intensity are transmitted.

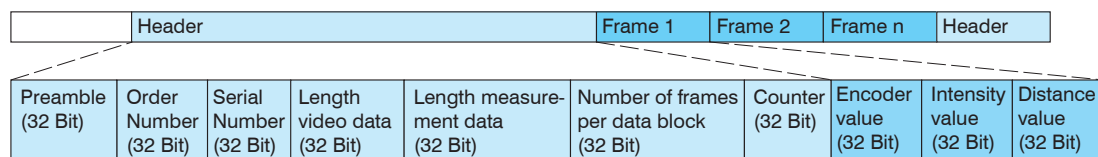

Fig. 90 Example for data transmission with Ethernet

A 5.5.2.2 Measurement Frame

A data packet typically contains one or more measurement data frames.

A measurement data frame comprises one or more signals. The content of a measurement data frame can be set using the `out_eth` command. `getoutinfo_eth` queries the structure of a measurement frame.

out_eth Parameter	Signal designation	Data type/range	Scaling	Unit
01RAW	Raw video signal channel 1	512 x uint16_t 0 ... 4095	-	ADC digits
01DARK	Dark corrected VS channel 1	512 x uint16_t 0 ... 4095	-	
01LIGHT	Light source corrected VS channel 1	512 x uint16_t 0 ... 65535	-	
02RAW	Raw video signal channel 2	512 x uint16_t 0 ... 4095	-	
02DARK	Dark corrected VS channel 2	512 x uint16_t 0 ... 4095	-	
02LIGHT	Light source corrected VS channel 2	512 x uint16_t 0 ... 65535	-	
01SHUTTER	Exposure Time channel 1	uint32_t 10 ... 100000	IFC2421/22: value / 10 IFC2465/66: value / 36	μ s
01ENCODER1	Encoder 1 channel 1	uint32_t 0 ... 2^{32-1}	-	Ticks
01ENCODER2	Encoder 2 channel 1	uint32_t 0 ... 2^{32-1}	-	Ticks
01INTENSITY	Intensity of peaks on channel 1	uint32_t 0 ... 1024	(value&7FF) / 1024*100	%
01DIST1 01DIST2 01DIST3 01DIST4 01DIST5 01DIST6	Distances of peak 1 to 6 for channel 1 Error codes, see A 5.5.2.4	int32_t INT32_MIN ... INT32_MAX	-	nm
02SHUTTER	Exposure Time channel 2	uint32_t 10 ... 100000	value / 10	μ s
02ENCODER1	Encoder 1 channel 2	uint32_t 0 ... 2^{32-1}	-	Ticks
02ENCODER2	Encoder 2 channel 2	uint32_t 0 ... 2^{32-1}	-	Ticks
02INTENSITY	Intensity of peaks on channel 2	uint32_t 0 ... 1024	(value&7FF) / 1024*100	%
02DIST1 02DIST2 02DIST3 02DIST4 02DIST5 02DIST6	Distances of peak 1 to 6 for channel 2 Error codes, see A 5.5.2.4	int32_t INT32_MIN ... INT32_MAX	-	nm
MEASRATE	Sample rate	uint32_t 1538 ... 100000	10*1000 /value	kHz
TIMESTAMP	Time Stamp	uint32_t 0 ... 2^{32-1}	value / 1000000	s
COUNTER	Measurement frame counter	uint32_t 0 ... 2^{32-1}		
STATE	Status word	uint32_t 0 ... 2^{32-1}	-	-
01PEAK	Peak Symmetry Value Channel 1	int32_t -8191 ... 8191 (18-bit decimal places)	-	
02PEAK	Peak Symmetry Value Channel 2	int32_t -8191 ... 8191 (18-bit decimal places)	-	

Signals configured and calculated by the COMP module are identical to the distance values regarding the data type and the range of values.

A 5.5.2.3 Example

The following example explains how to output the exposure time, distance 1, distance 2 and the intensity for channel 1 and channel 2.

- Determine two peaks to be evaluated:

```
PEAKCOUNT_CH01 2
```

```
PEAKCOUNT_CH02 2
```

- Set the signals with OUT_ETH:

```
OUT_ETH 01SHUTTER 01DIST1 01DIST2 01INTENSITY 02SHUTTER 02DIST1  
02DIST2 02INTENSITY
```

- Query the signal sequence in the measurement frame:

```
GETOUTINFO_ETH 01SHUTTER 01INTENSITY1 01DIST1 01INTENSITY2 01DIST2  
02SHUTTER 02INTENSITY1 02DIST1 02INTENSITY2 02DIST2
```

- Start the output:

```
OUTPUT Ethernet
```

A 5.5.2.4 Error Codes Ethernet Interface

Within the distance values, [see A 5.5.2.2](#), a range from 0x7FFFFFF0 to 0x7FFFFFFF is reserved for error values/codes. The following error codes are defined:

Error code	Description
0x7FFFFFF0	There is no peak present
0x7FFFFFF1	Peak is located in front of the measuring range (MR)
0x7FFFFFF2	Peak is located behind of the measuring range (MR)
0x7FFFFFF3	Measuring value cannot be calculated
0x7FFFFFF4	Measuring value is outside the representable area

A 5.5.3 Ethernet Video Signal Transmission

The video signal transmission is effected to a measurement value server via Ethernet analog to the measurement data transmission, [see A 5.5.2](#), except, that only one video signal is transmitted in a measurement value block and each video signal must be requested individually.

This measurement value block can vary also over different TCP/IP or UDP/IP packets depending on the size of the video signal.

The preamble for the video signals is 0x41544144 "DATA".

Request a video signal:

Use the commands OUT_ETH and OUT_RS422.

OUTPUT ETHERNET	-> Output via the Ethernet
-----------------	----------------------------

A 5.6 Warning and Error Messages

- E200 I/O operation failed
- E202 Access denied
- E204 Received unsupported character
- E205 Unexpected quotation mark
- E210 Unknown command
- E212 Command not available in current context
- E214 Entered command is too long to be processed
- E230 Unknown parameter
- E231 Empty parameters are not allowed
- E232 Wrong parameter count
- E233 Command has too many parameters
- E234 Wrong or unknown parameter type
- E236 Value is out of range or the format is invalid
- E262 Active signal transfer, please stop before
- E270 No signals selected
- E272 Invalid combination of signal parameters, please check measure mode and signal selection
- E276 Given signal is not selected for output
- E277 One or more values were unavailable. Please check output signal selection
- E281 Not enough memory available
- E282 Unknown output signal
- E283 Output signal is unavailable with the current configuration
- E284 No configuration entry was found for the given signal
- E285 Name is too long
- E286 Names must begin with an alphabetic character, and be 2 to 15 characters long. Permitted characters are: a-zA-Z0-9_
- E320 Wrong info-data of the update
- E321 Update file is too large
- E322 Error during data transmission of the update
- E323 Timeout during the update
- E324 File is not valid for this sensor
- E325 Invalid file type
- E327 Invalid checksum
- E331 Validation of import file failed
- E332 Error during import
- E333 No overwrite during import allowed
- E340 Too many output values for RS422 selected
- E350 The new passwords are not identical
- E351 No password given
- E360 Name already exists or not allowed
- E361 Name begins or ends with spaces or is empty
- E362 Storage region is full

E363 Setting name not found
E364 Setting is invalid
E500 Material table is empty
E502 Material table is full
E504 Material name not found
E600 ROI begin must be less than ROI end
E602 Master value is out of range
E603 One or more values were out of range
E610 Encoder: minimum is greater than maximum
E611 Encoder's start value must be less than the maximum value
E615 Synchronization as slave and triggering at level or edge are not possible at the same time
E616 Software triggering is not active
E618 Sensor head not available
E621 The entry already exists
E622 The requested dataset/table doesn't exist.
E623 Not available in EtherCAT mode
E624 Not allowed when EtherCAT SYNC0 synchronization is active

W505 Refractivity correction deactivated, vacuum is used as material
W526 Output signal selection modified by the system
W528 The shutter time has been changed to match the measurement rate and the system requirements.
W530 The IP settings has been changed.

A 6 EtherCAT Documentation

A 6.1 General

EtherCAT® is, from the Ethernet viewpoint, a single, large Ethernet station that transmits and receives Ethernet telegrams. Such an EtherCAT system consists of an EtherCAT master and up to 65,535 EtherCAT slaves.

Master and slaves communicate via standard Ethernet wiring. On-the-fly processing hardware is used in each slave. The incoming Ethernet frames are directly processed by the hardware. Relevant data are extracted from the frame or used based on the frame. The frame is then sent on to the next EtherCAT® slave device. The last slave device sends back the fully processed frame. Various protocols can be used on application level. CANopen over EtherCAT technology (CoE) is supported here. The CANopen protocol uses an object tree with Service Data Objects (SDOs) and Process Data Objects (PDOs) to manage the data. Further information can be obtained from ® Technology Group (www.ethercat.org) or Beckhoff GmbH (www.beckhoff.com).

A 6.2 Switching between Ethernet and EtherCAT

You can switch between Ethernet and EtherCAT via an ASCII command, see A 5.3.7.5, or EtherCAT object, see A 6.4.2.21. The switch becomes active only after restarting the controller. Note: Save the current settings before switching to EtherCAT.

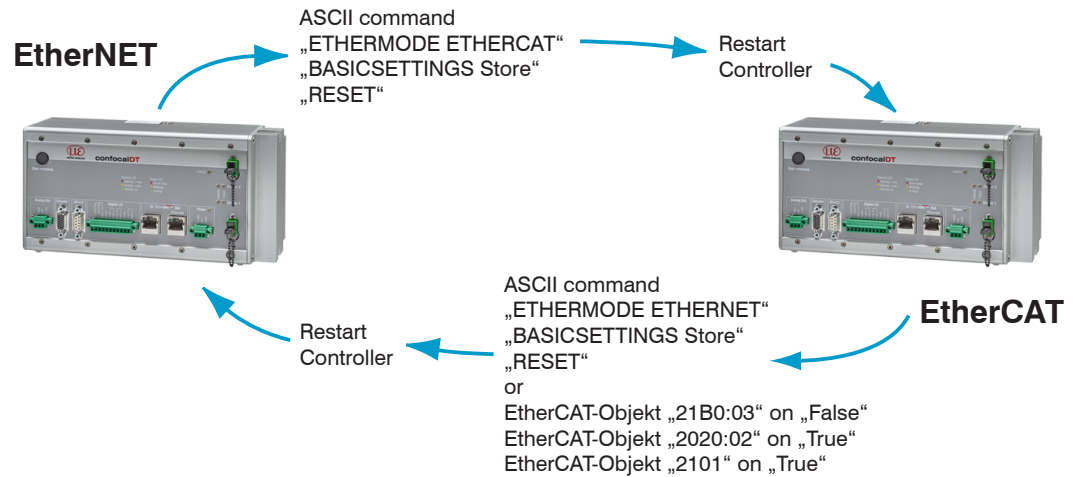

The RS422 interface for sending an ASCII command is available both in Ethernet mode and in EtherCAT mode.

A 6.3 Introduction

A 6.3.1 Structure of EtherCAT® Frames

Data are transferred in Ethernet frames with a special Ether type (0x88A4). Such an EtherCAT® frame consists of one or several EtherCAT® telegrams, each of which is addressed to individual slaves/storage areas. The telegrams are either transmitted directly in the data area of the Ethernet frame or in the data area of the UDP datagram. An EtherCAT® telegram consists of an EtherCAT® header, the data area and the work counter (WC). The work counter is incremented by each addressed EtherCAT® slave that exchanged the corresponding data.

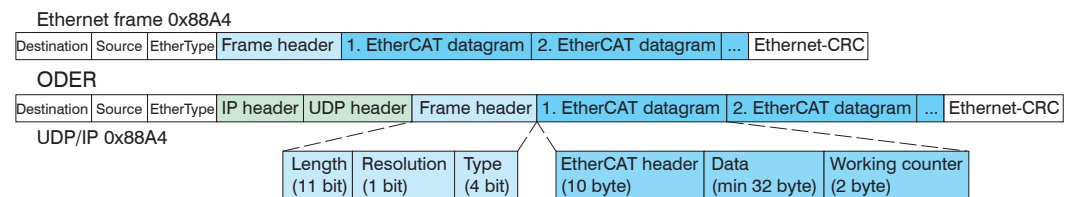

Fig. 92 Design of EtherCAT frames

A 6.3.2 EtherCAT® services

Within EtherCAT®, the services for reading and writing data are specified in the physical memory of the slave hardware. The following EtherCAT® services are supported by the slave hardware:

- APRD (Auto-Increment Physical Read, reading of a physical area with auto-increment addressing)
- APWR (Auto-Increment Physical Write, writing of a physical area with auto-increment addressing)
- APRW (Auto-Increment Physical Read Write, reading and writing of a physical area with auto-increment addressing)
- FPRD (Configured Address Read, reading of a physical area with fixed addressing)
- FPWR (Configured Address Write, writing of a physical area with fixed addressing)
- FPRW (Configured Address Read Write, reading and writing of a physical area with fixed addressing)
- BRD (Broadcast Read, broadcast-reading of a physical area for all slaves)
- BWR (Broadcast Write, broadcast-writing of a physical area for all slaves)
- LRD (Logical Read, reading of a logical storage area)
- LWR (Logical Write, writing of a logical storage area)
- LRW (Logical Read Write, reading and writing of a logical storage area)
- ARMW (Auto-Increment Physical Read Multiple Write, reading of a physical area with auto-increment addressing, multiple writing)
- FRMW (Configured Address Read Multiple Write, reading of a physical area with fixed addressing, multiple writing)

A 6.3.3 Addressing and FMMUs

The master can use a variety of methods to address a slave in the EtherCAT® system. The confocalDT 2421/2422/2465/2466 supports as full slave:

- Position addressing
The slave device is addressed via its physical position in the EtherCAT® segment. The services used for this are APRD, APWR, APRW.
- Node addressing
The slave device is addressed via a configured node address, which was assigned by the master during the commissioning phase. The services used for this are FPRD, FPWR and FPRW.
- Logical addressing
The slaves are not addressed individually; instead, a segment of the segment-wide logical 4-GB address is addressed. This segment can be used by a number of slaves. The services used for this are LRD, LWR and LRW.

The local assignment of physical slave memory addresses and logical segment-wide addresses is implemented via the Fieldbus Memory Management Units (FMMUs). The configuration of the slave FMMUs is implemented by the master. The FMMU configuration contains a start address for the physical memory in the slave, a logical start address in the global address space, length and type of the data, as well as the direction (input or output) of the process data.

A 6.3.4 Sync managers

Sync managers support data consistency during the data exchange between EtherCAT® master and slaves. Each sync manager channel defines a specific application memory area. The confocalDT 2421/2422/2465/2466 has four channels:

- Sync manager channel 0: Sync manager 0 is used for mailbox write transfers (mailbox from master to slave).
- Sync manager channel 1: Sync manager 1 is used for mailbox read transfers (mailbox from slave to master).
- Sync manager channel 2: Sync Manager 2 is typically used for process output data. Not used in the controller.
- Sync manager channel 3: Sync Manager 3 is typically used for process input data. It contains the Tx PDOs that are specified by the PDO assignment object 0x1C13 (hex.).

A 6.3.5 EtherCAT state machine

The EtherCAT® state machine is part of each EtherCAT® slave. Directly after switching on the confocalDT 2421/2422/2465/2466, the state machine is in the “initialization” state. In this state, the master has access to the DLL information register of the slave hardware. The mailbox is not yet initialized, i.e. communication with the application (controller software) is not yet possible. During the transition to the pre-operational state, the sync manager channels are configured for mailbox communication. In the pre-operational state, communication via the mailbox is possible and the object directory and its objects can be accessed. In this state, no process data communication occurs. During the transition to the safe-operational state, the master configures the process-data mapping, the sync manager channel of the process inputs and the corresponding FMMU. Mailbox communication continues to be supported in the safe-operational state. Process data communication is enabled for the inputs. The outputs are in a “safe” state. In the operational state, process data communication is enabled for inputs and outputs.

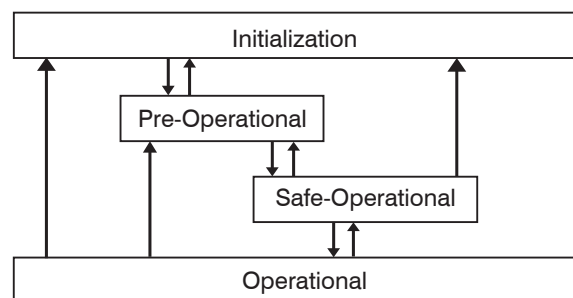

Fig. 93 EtherCAT state machine

A 6.3.6 CANopen over EtherCAT

The application level communication protocol in EtherCAT is based on the communication profile CANopen DS 301. It is called “CANopen over EtherCAT” or CoE. The protocol specifies the object directory in the controller as well as the communication objects for the exchange of process data and acyclic messages. The controller uses the following message types:

- Process Data Object (PDO). The PDO is used for cyclic I/O communication (i. e. for process data).
- Service Data Object (SDO). The SDO is used for acyclic data transfer.

The object directory is described in Chapter “CoE Object Directory”.

A 6.3.7 Process data PDO mapping

Process data objects (PDOs) are used for the exchange of time-critical process data between master and slave. Tx PDOs are used to transfer data from the slave to the master (inputs). Rx PDOs are used to transfer data from the master to the slave (outputs); this concept is not used in the confocalDT 2421/2422/2465/2466. The PDO mapping defines which application objects (measurement data) are transmitted into a PDO.

The confocalDT 2421/2422/2465/2466 lets the user choose from a selection of Tx PDO mapping objects, see A 6.4.1.7.

In EtherCAT the PDOs are transported in sync manager channel objects. The controller uses the sync manager channel SM3 for input data (Tx data). The PDO assignments of the sync manager can only be modified in the pre-operational state.

Note: Sub-index 0h of the object 0x1A00 contains the number of valid entries within the mapping report. This figure also represents the number of application variables (parameters) that should be transmitted/received with corresponding PDO. The sub-indices from 1h up to the number of objects contain information about the depicted application variables. The mapping values in the CANopen objects are coded in hexadecimal form. The following table contains an example of the entry structure for the PDO mapping:

MSB		LSB	
31	16	15	0
Index e. g. 0x6000 (16 bit)		Sub-index e.g. 0x01	Object length in bits, e. g. 20h = 32 bits

Fig. 94 Sample entry structure for the PDO mapping

A 6.3.8 Service data SDO service

Service Data Objects (SDOs) are primarily used for the transmission of data that are not time-critical, e.g. parameter values.

EtherCAT specifications

- SDO services make possible the read/write access to entries in the CoE object directory of the device.
- SDO information services make it possible to read the object directory itself and to access the properties of the objects.

All parameters of the measuring device can be read or changed in this way, and measurements can be transmitted. A desired parameter is addressed via index and sub-index within the object directory.

A 6.4 CoE object directory

The CoE object directory (CANopen over EtherCAT) contains all configuration data of the controller. The objects in the CoE object directory can be called with the SDO services. Each object is addressed based on a 16-bit index.

A 6.4.1 Communication-specific standard objects

A 6.4.1.1 Overview

Index (h)	Name	Description
1001	Device type	Device type
1008	Device name	Manufacturer's device name
1009	Hardware version	Hardware version
100A	Software version	Software version
1018	Identity	Device identification
1A00 ... 1BAB		TxPDO Mapping, see A 6.4.1.7 PDO mapping objects may contain merged process data (mappable objects).
1C00	Sync. manager type	Type of synchronization manager
1C12	RxPDO assign	
1C13	TxPDO assign	TxPDO assign
1C33	Sync manager input parameter	Synchronous mode parameter (DC)

Fig. 95 Standard objects - Overview

A 6.4.1.2 Object 1001h: Device type

1001	VAR	Device type	0x00000000	Unsigned32	ro
------	-----	-------------	------------	------------	----

Supplies information about the device profile and the device type used.

A 6.4.1.3 Object 1008h: Manufacturer's device name

1008	VAR	Device name	IFC24xx	Visible string	ro
------	-----	-------------	---------	----------------	----

A 6.4.1.4 Object 1009h: Hardware version

1009	VAR	Hardware version	xx	Visible string	ro
------	-----	------------------	----	----------------	----

A 6.4.1.5 Object 100Ah: Software version

100A	VAR	Software version	xxx.xxx	Visible string	ro
------	-----	------------------	---------	----------------	----

A 6.4.1.6 Object 1018h: Device identification

1018	RECORD	Identity			
------	--------	----------	--	--	--

Sub-indices

0	VAR	Number of entries	4	Unsigned8	ro
1	VAR	Vendor ID	0x00000607	Unsigned32	ro
2	VAR	Product code	0x0024E555	Unsigned32	ro
3	VAR	Revision	0x00010000	Unsigned32	ro
4	VAR	Serial number	0x009A4435	Unsigned32	ro

The article number is defined in the `product code`; the serial number of the controller is defined in the `serial number`.

A 6.4.1.7 TxPDO Mapping

1A00	Ch01Dist1 TxPDOMap					
	CH01DIST1 0x6000					
1A08	Ch02Dist1 TxPDOMap					
	CH02DIST1 0x6800					
1A10	Ch01Dist2 TxPDOMap					
	CH01DIST2 0x6001					
1A18	Ch02Dist2 TxPDOMap					
	CH02DIST2 0x6801					
1A20	Ch01Dist3to6 TxPDOMap					
	CH01DIST3 0x6002	CH01DIST4 0x6003	CH01DIST5 0x6004	CH01DIST6 0x6005		
1A28	Ch02Dist2 TxPDOMap					
	CH02DIST2 0x6802	CH02DIST4 0x6803	CH02DIST5 0x6804	CH02DIST6 0x6805		
1A30	Ch01Intensity1 TxPDOMap					
	CH01INTENSITY1 0x6010					
1A38	Ch02Intensity1 TxPDOMap					
	CH02INTENSITY1 0x6810					
1A40	Ch01Intensity2 TxPDOMap					
	CH01INTENSITY2 0x6011					
1A48	Ch02Intensity2 TxPDOMap					
	CH02INTENSITY2 0x6811					
1A50	Ch01Intensity3to6 TxPDOMap					
	CH01INTENSITY3 0x6012	CH01INTENSITY4 0x6013	CH01INTENSITY5 0x6014	CH01INTENSITY6 0x6015		
1A58	Ch02Intensity3to6 TxPDOMap					
	CH02INTENSITY3 0x6812	CH02INTENSITY4 0x6813	CH02INTENSITY5 0x6814	CH02INTENSITY6 0x6815		
1A60	Ch01Unlin1and2					
	CH01UNLIN1 0x6020	CH01UNLIN2 0x6021				
1A68	Ch02Unlin1and2					
	CH02UNLIN1 0x6820	CH02UNLIN2 0x6821				
1A70	Ch01Unlin3to6 TxPDOMap					
	CH01UNLIN3 0x6022	CH01UNLIN4 0x6023	CH01UNLIN5 0x6024	CH01UNLIN6 0x6025		
1A78	Ch02Unlin3to6 TxPDOMap					
	CH02UNLIN3 0x6822	CH02UNLIN4 0x6823	CH02UNLIN5 0x6824	CH02UNLIN6 0x6825		
1A80	Ch01States TxPDOMap					
	CH01SHUTTER 0x6030	CH01ENCODER1 0x6050	CH01ENCODER2 0x6051			
1A88	Ch02States TxPDOMap					
	CH02SHUTTER 0x6830	CH02ENCODER1 0x6850	CH02ENCODER2 0x6851			
1A90	Ch01PeakSymm1					
1A98	Ch02PeakSymm1					
1AA0	Ch01PeakSymm2					

1AA8	Ch02PeakSymm2					
1AB0	Ch01PeakSymm3to6					
	CH01PEAKSYMM3 0x6062	CH01PEAKSYMM4 0x6063	C01PEAKSYMM5 0x6064	C01PEAKSYMM6 0x6065		
1AB8	Ch02PeakSymm3to6					
	CH02PEAKSYMM3 0x6862	CH02PEAKSYMM4 0x6863	CH02PEAKSYMM5 0x6864	CH- 02PEAKSYMM6 0x6865		
1AE0	Counter TxPDOMap					
	COUNTER 0x7000					
1AE8	States TxPDOMap					
	TIMESTAMP 0x7001					
1AF0	Frequency TxPDOMap					
	FREQUENCY 0x7002					
1B00	UserCalc01 TxPDOMap					
	UserCalcOutput01 0x7C00					
1B08	UserCalc02 TxPDOMap					
	UserCalcOutput02 0x7C01					
1B10	UserCalc03 TxPDOMap					
	UserCalcOutput03 0x7C02					
1B18	UserCalc04 TxPDOMap					
	UserCalcOutput04 0x7C03					
1B20	UserCalc05and06 TxPDOMap					
	UserCalcOutput05 0x7C04	UserCalcOutput06 0x7C05				
...	...					
1B58	UserCalc19and20 TxPDOMap					
	UserCalcOutput19 0x7C12	UserCalcOutput20 0x7C13				
1B60	UserCalc21to24 TxPDOMap					
	UserCalcOutput21 0x7C14	UserCalcOutput22 0x7C15	UserCalcOutput23 0x7C16	UserCalcOut- put24 0x7C17		
...	...					
1BA8	UserCalc57to60 TxPDOMap					
	UserCalcOutput57 0x7C38	UserCalcOutput58 0x7C39	UserCalcOutput59 0x7C3A	UserCalcOut- put60 0x7C3B		

Fig. 96 PDO mapping objects

In object 0x1C13 is selected which PDOs are transferred. The PDO mapping objects are selected. The selection process takes place before switching from PreOP to SafeOP mode.

Example 1: Startup procedure to output distance 1 from channel 1 (01DIST1):

- Distance 1 is expressed in 0x6000. In order to transfer 0x6000 in the PDO, the PDO mapping object 0x1A00 must be selected in 0x1C13.

Object	Value	Description
0x1C13:00	0x00 (0)	clear sm pdos (0x1C13)
0x1C13:01	0x1A00 (6656)	download pdo 0x1C13:01 index
0x1C13:00	0x01 (1)	download pdo 0x1C13 count

Example 2: Startup procedure to output distance 1, intensity 1, shutter speed, encoder 1 and encoder 2 from channel 1 (01DIST1, 01INTENSITY1, 01SHUTTER, 01ENCODER1, 01ENCODER2).

- Distance 1 is expressed in 0x6000. In order to transfer 0x6000 in the PDO, the PDO mapping object 0x1A00 must be selected in 0x1C13.
- Intensity 1 is expressed in 0x6010. In order to transfer 0x6010 in the PDO, the PDO mapping object 0x1A30 must be selected in 0x1C13.
- The shutter speed is expressed in 0x6030, encoder 1 in 0x6050 and encoder 2 in 0x6051. The four process data are merged in 0x1H80 and must be selected in 0x1C13 for transfer in the PDO.

Object	Value	Description
0x1C13:00	0x00 (0)	clear sm pdos (0x1C13)
0x1C13:01	0x1A00 (6656)	download pdo 0x1C13:01 index
0x1C13:02	0x1A30 (6704)	download pdo 0x1C13:02 index
0x1C13:03	0x1A80 (6768)	download pdo 0x1C13:03 index
0x1C13:00	0x03 (3)	download pdo 0x1C13 count

A 6.4.1.8 Object 1C00h: Type of synchronization manager

1C00	RECORD	Sync manager type			ro
------	--------	-------------------	--	--	----

Sub-indices

Index	Type	Description	Value	Length	Access
0	VAR	Number of entries	4	Unsigned8	ro
1	VAR	Sync manager 1	0x01	Unsigned8	ro
2	VAR	Sync manager 2	0x02	Unsigned8	ro
3	VAR	Sync manager 3	0x03	Unsigned8	ro
4	VAR	Sync manager 4	0x04	Unsigned8	ro

A 6.4.1.9 Object 1C12h: RxPDO Assign

1C12	ARRAY	RxPDO Assign			rw
------	-------	--------------	--	--	----

Sub-indices

0	VAR	Number of entries	0	Unsigned8	ro
---	-----	-------------------	---	-----------	----

No RxPDOs can be selected because none are present. The object is implemented as a dummy to enable the EtherCAT master to set the RxPDOs to 0.

A 6.4.1.10 Object 1C13h: TxPDO Assign

1C13	ARRAY	TxPDO Assign			rw
------	-------	--------------	--	--	----

Sub-indices

Index	Type	Description	Value	Length	Access
0	VAR	Number of entries	n	Unsigned8	rw
1	VAR	Sub-index 001	0x1A00	Unsigned16	rw
2	VAR	Sub-index 002		Unsigned16	rw
..					
n	VAR	Sub-index n	-	Unsigned16	rw

Object for selecting the PDOs (TxPDO maps), [see A 6.4.1.7](#).

A 6.4.1.11 Object 1C33h: Synchronization manager input parameters

1C33	RECORD	SM input parameter			ro
Sub-indices					
0	VAR	Number of entries	9	Unsigned8	ro
1	VAR	Synchronization type	x	Unsigned16	ro
2	VAR	Cycle time	x	Unsigned32	ro
4	VAR	Supported synchronization types	0x4005	Unsigned16	ro
5	VAR	Minimum cycle time	1000000	Unsigned32	ro
6	VAR	Calc and copy time	x	Unsigned32	ro
8	VAR	Get cycle time	x	Unsigned16	rw
9	VAR	Delay time		Unsigned32	ro

- Synchronization Type: currently specified synchronization
 - 0: Freerun,
 - 2: Distributed clock Sync0 synchronization, [see A 6.9.2](#)
- Cycle Time: currently specified cycle time in ns
 - Free run, the cycle time derived from the measuring rate,
 - Sync0 synchronization, the Sync0 cycle time set by the master.

The minimum cycle time is derived from the maximum measuring rate and equals 153.846 μ s.

- Supported synchronization types: Free run and Sync0 synchronization are supported
- Calc and Copy Time, Get Cycle Time: If “Get Cycle Time” is set to 1, the Calc and Copy time is measured and displayed in the entry of the same name (only for Sync0 synchronization)
- Delay time: SYNC0 pulse triggers the sampling; therefore this value is always 0.

A 6.4.2 Manufacturer-specific objects

A 6.4.2.1 Overview

Index (h)	Name	IFC2421 IFC2465	IFC2422 IFC2466	Description
2001	User level	•	•	Login, logout, change password
2005	Controller information	•	•	Controller info (continued)
2011	Correction ch 1	•	•	Dark reference
3011	Correction ch 2		•	
2020	Basic settings	•	•	Load, save, factory settings
2021	Preset	•	•	
2022	Meas. settings	•	•	Measurement setting
203F	Sensor error	•	•	Sensor error for channel 1/2
2101	Reset	•	•	Restart controller
2105	Factory reset	•	•	Reset to factory settings
2107	Counter reset	•	•	Reset counter
2133	LED on/off ch 1	•	•	LED light source channel 1/2
3133	LED on/off ch 2		•	
2141	Video signal	•	•	Request video signal
2142	Video signal enable ch 1	•	•	Share video signal
3142	Video signal enable ch 2		•	
2150	Sensor ch 1	•	•	Sensor information for channel 1/2
3150	Sensor ch 2		•	
2152	Select sensor ch 1	•	•	Select sensor for channel 1/2
3152	Select sensor ch 2		•	
2156	Multilayer options ch 1	•	•	Multilayer options for channel 1/2
3156	Multilayer options ch 2		•	
2161	Peak position ch 1	•	•	Peak selection for channel 1/2
3161	Peak position ch 2		•	
2162	Peak options ch 1	•	•	Peak options for channel 1/2
3162	Peak options ch 2		•	
2183	Spike correction ch 1	•	•	Spike correction for channel 1/2
3183	Spike correction ch 2		•	
21B0	Digital interfaces	•	•	Digital interfaces
21B1	Enable output	•	•	Select interface
21C0	Ethernet	•	•	Ethernet, IP configuration
21D0	Analog output	•	•	Analog output, scaling
21F3	Switching output 1	•	•	Switching output 1/2
21F4	Switching output 2		•	
2250	Shutter mode ch 1	•	•	Exposure mode for channel 1/2
3250	Shutter mode ch 2		•	
2251	Measuring rate	•	•	Measuring rate
24A0	Keylock	•	•	Locks the multi-function button on the controller
24A2	Keyfunc	•	•	Functionality of the multi-function button
25A0	Encoder	•	•	
2711	Range of interest ch 1	•	•	Masks the evaluation range for channel 1/2
3711	Range of interest ch 2		•	
2800	Material info and edit	•	•	Material information
2802	Material table edit	•	•	Edit material table
2803	Material table	•	•	Existing materials in the material table
2804	Material selection ch 1	•	•	Select material for channel 1/2
3804	Material selection ch 2		•	

Index (h)	Name	IFC2421 IFC2465	IFC2422 IFC2466	Description
2A00-2A09	Master y	•	•	Master value, mastering
2A10-2A09	Statistic y	•	•	Statistics
2C00-2C09	Comp y ch 1	•	•	Measured value calculation for channel 1/2
3C00-3C09	Comp y ch 2		•	
2CBF	Sys Signals	•	•	
2CC0-2CC9	Comp y sys	•	•	
2E00	User calc	•	•	

i Invalid entries when reading and writing manufacturer-specific objects can result in errors. These errors are described in the SDO abort codes, [see A 6.6](#). If an error occurs while writing a value, you may be able to retrieve error details in object 203F.

A 6.4.2.2 Object 2001h: User level

2001	RECORD	User level			
Sub-indices					
0	VAR	Number of entries	7	Unsigned8	ro
1	VAR	Actual user	x	Unsigned8	ro
2	VAR	Login		Visible string	wo
3	VAR	Logout	FALSE	BOOL	rw
4	VAR	Default user	x	Unsigned8	rw
5	VAR	Old password		Visible string	wo
6	VAR	New password		Visible string	wo
7	VAR	Repeat password		Visible string	wo

For more information, please refer to the Login section, [see 6.6.4](#), and the User Level section, [see A 5.3.2.1](#).

Actual user, Default user:

- 0 - Operator
- 1 - Expert

Modifying the user level will change the access rights for objects. Once you `log out`, RW objects change to read-only (= ro), and write-only objects (= wo) are no longer available.

To change the password, you need to complete the three passwords fields (Old, New and Repeat) in this particular order. The maximum password length is 31 characters.

A 6.4.2.3 Object 2005h: Controller info (continued)

2005	RECORD	Controller Info			ro
Sub-indices					
0	VAR	Number of entries	8	Unsigned8	ro
1	VAR	Name	IFC242x	Visible string	ro
5	VAR	Serial No	xxxxxxx	Visible string	ro
6	VAR	Option no	xxx	Visible string	ro
8	VAR	Article no	xxxxxxx	Visible string	ro

For more information, please refer to the Controller Information section, [see A 5.3.1.2](#).

A 6.4.2.4 Object 2011h: Correction, channel 1

2010	RECORD	Correction channel 1			ro
Sub-indices					
0	VAR	Number of entries	3	Unsigned8	ro
1	VAR	Dark correction	FALSE	BOOL	wo
3	VAR	Correction state	x	Unsigned32	ro

Setting 1 (True) to sub-index 1 triggers a dark reference. Sub-index 3 displays the state of the correction; valid values include:

- 0: no correction active
- 1: correction active
- 100: error during the correction process

Once correction has been initiated, the status changes from 0 to 1. If no error occurs, the status changes back to 0 when correction is completed. No settings may be changed while a correction is active.

For more information, please refer to the Dark Referencing section, [see 5.5](#), and the Dark Reference section, [see A 5.3.4.4](#).

A 6.4.2.5 Object 2020h: Load, save, factory settings

2020	RECORD	Basic settings			ro
------	--------	----------------	--	--	----

Sub-indices

0	VAR	Number of entries	3	Unsigned8	ro
1	VAR	READ		BOOL	wo
2	VAR	STORE		BOOL	wo
3	VAR	SETDEFAULT		BOOL	wo

- READ: Loads the last saved basic settings
- STORE: Stores the current settings
- SETDEFAULT: Resets the basic settings to factory defaults

A 6.4.2.6 Object 2021h: Preset

2021	RECORD	Preset			ro
------	--------	--------	--	--	----

Sub-indices

0	VAR	Number of entries	3	Unsigned8	ro
1	VAR	Mode	x	Unsigned8	rw
2	VAR	List		Visual string	ro
3	VAR	Named read		Visual string	wo

Mode:

- 0 – STATIC
- 1 – BALANCED
- 2 – DYNAMIC

For more information, please refer to the Measurement Settings section, [see A 6.4.2.7](#).**A 6.4.2.7 Object 2022h: Measurement settings**

2022	RECORD	Meas. settings			ro
------	--------	----------------	--	--	----

Sub-indices

0	VAR	Number of entries	7	Unsigned8	
1	VAR	Current		Visual string	ro
2	VAR	Named read		Visual string	wo
3	VAR	Named store		Visual string	wo
4	VAR	Named delete		Visual string	wo
5	VAR	Initial meas. settings		Visual string	rw
6	VAR	List		Visual string	ro
7	VAR	Set default		BOOL	wo

- Current: Current measurement settings (MEASSETTINGS CURRENT)
- Named read: Loads a measurement setting from the `list/sub-index 6` (MEASSETTINGS READ)
- Named store: Stores the current measurement setting. You can assign a name or number (MEASSETTINGS STORE)
- Named delete: Deletes a measurement setting from the `list/sub-index 6` (MEASSETTINGS DELETE)
- Initial meas. settings: Measurement setting that is initially loaded during a controller reset (MEASSETTINGS INITIAL)
- List: List with stored measurement settings (MEASSETTINGS LIST)
- Set default: Corresponds to the SETDEFAULT MEASSETTINGS command

For more information, please refer to the Measurement Settings section, [see A 5.3.8.6](#).

A 6.4.2.8 Object 203Fh: Sensor error

203F	RECORD	Sensor error			ro
Sub-indices					
0	VAR	Number of entries	2	Unsigned8	ro
1	VAR	Sensor error number	x	Unsigned16	ro
2	VAR	Sensor error description	x	Visible string	ro

For more information, please refer to the Error Messages section.

- Sensor error number: Outputs the sensor error during communication
- Sensor error description: Sensor error as plain text

A 6.4.2.9 Object 2101h: Reset

2101	VAR	Reset	FALSE	BOOL	rw
------	-----	-------	-------	------	----

Restarts the controller.

A 6.4.2.10 Object 2105h: Factory settings

2105	VAR	Factory reset		BOOL	wo
------	-----	---------------	--	------	----

Reset to factory defaults. Corresponds to the SETDEFAULT ALL command.

A 6.4.2.11 Object 2107h: Reset counter

2107	RECORD	Counter reset			ro
Sub-indices					
0	VAR	Number of entries	2	Unsigned8	ro
1	VAR	Reset timestamp		BOOL	wo
2	VAR	Reset counter		BOOL	wo

Setting sub-index 1 to 1 will reset the time stamp (0x7001). Setting sub-index 2 to 1 will reset the measured value counter (0x7000).

A 6.4.2.12 Object 2133h: LED light source channel 1

2133	VAR	LED on/off ch1		BOOL	rw
------	-----	----------------	--	------	----

Allows you to turn on or off the LED light source. Corresponds to the LED command. Object 3133h includes the LED light source for channel 2.

A 6.4.2.13 Object 2141h: Request video signal

2141	RECORD	Video signal			ro
Sub-indices					
0	VAR	Number of entries	1	Unsigned8	ro
2	VAR	New frame request		BOOL	wo

If the video signal output is enabled (either for channel 1 (0x2142:1) and/or channel 2 (0x3142:1)), this entry can be used to trigger a new image.

A 6.4.2.14 Object 2142h: Share video signal

2142	RECORD	Video signal enable ch1			ro
Sub-indices					
0	VAR	Number of entries	1	Unsigned8	ro
1	VAR	Enable dark corrected signal		BOOL	rw

Allows to output the video signal for channel 1 in object 0x8000h. Object 3142h includes the video signal enable mechanism for channel 2.

A 6.4.2.15 Object 2150h: Sensor channel 1

2150	RECORD	Sensor ch1			ro
Sub-indices					
0	VAR	Number of entries	3	Unsigned8	ro
1	VAR	Sensor info	IFS242x-xx	Visible string	ro
2	VAR	Sensor range	xx.xxxxxx	FLOAT32	ro
3	VAR	Sensor serial no.	xxxxxxx	Visible string	ro

For more information, please refer to the Sensor section, [see A 5.3.4](#). Object 3150h includes the sensor information for channel 2.

A 6.4.2.16 Object 2152h: Sensor selection channel 1

2152	RECORD	Select sensor ch1			ro
Sub-indices					
0	VAR	Number of entries	1	Unsigned8	ro
1	VAR	Number of sensor	x	Unsigned8	rw

For more information, please refer to the Selecting a Sensor section, [see A 5.3.4](#) and Sensor Number section, [see A 5.3.4.2](#). Object 3152h includes the sensor selection information for channel 2.

A 6.4.2.17 Object 2156h: Multilayer options for channel 1

2156	RECORD	Multilayer options ch1			ro
Sub-indices					
0	VAR	Number of entries	2	Unsigned8	ro
1	VAR	Peak count		Unsigned8	rw
2	VAR	Disable refractivity correction	FALSE	BOOL	rw

Includes the options for thickness and multilayer measurements. Sub-index 1 corresponds to the PEAKCOUNT(_CH0x) command. Sub-index 2 corresponds to the REFRACTCORR(_CH0x) command. Object 3156h includes the multilayer options for channel 2.

Disable refractivity correction: Disables the refractive index correction

A 6.4.2.18 Object 2161h: Peak selection for channel 1

2161	VAR	Peak position	0	Unsigned8	rw
------	-----	---------------	---	-----------	----

Use this command to define the peaks that are evaluated in the distance/thickness measurement mode.

Standard: first peak / first and second peak

In order to receive transparent measuring results, the standard setting should only be changed where absolutely required.

Position for distance measurement		Position for thickness measurement	
0	first peak	0	first and last peak
1	last peak	1	second-last and last peak
2	first peak	2	first and second peak
3	highest peak	3	highest and second-highest peak

Object 3161h includes the peak selection for channel 2.

A 6.4.2.19 Object 2162h: Peak options for channel 1

2162	RECORD	Peak options ch1			ro
Sub-indices					
0	VAR	Number of entries	2	Unsigned8	ro
1	VAR	Min threshold		FLOAT32	rw
2	VAR	Peak modulation		FLOAT32	rw

Min threshold: Peak detection threshold, corresponds to the MIN_THRESHOLD(_CH0x) command.

Object 3162h includes the peak options for channel 2.

A 6.4.2.20 Object 2183h: Spike correction for channel 1

2183	RECORD	Spike correction ch1			ro
Sub-indices					
0	VAR	Number of entries	4	Unsigned8	ro
1	VAR	Enable		BOOL	rw
2	VAR	Evaluation length		Unsigned32	rw
3	VAR	Range		FLOAT32	rw
4	VAR	Count		Unsigned32	rw

For more information, please refer to the SPIKECORR(_CH0x) command, [see A 5.3.11.1](#). When this function is activated via sub-index 1, the default values are specified for sub-indices 2 to 4.

Object 3183h includes the spike correction for channel 2.

A 6.4.2.21 Object 21B0h: Digital interfaces

21B0	RECORD	Digital interfaces			ro
Sub-indices					
0	VAR	Number of entries	2	Unsigned8	ro
2	VAR	RS422 baud rate	x	Unsigned32	rw
3	VAR	Ethermode		Unsigned8	rw

Sub-index 2 corresponds to the BAUDRATE command. You can only select from the predefined baud rates. Sub-index 3 corresponds to the ETHERMODE command.

RS422 baud rate: 9600, 115200, 230400, 460800, 691200, 921600, 1500000, 2000000, 3500000, 4000000

EtherCAT Ethernet: (Change of interface)

0 - Ethernet (effective only after restart; first use `Basicsettings store`)

1 - EtherCAT

A 6.4.2.22 Object 21B1h: Select interface

21B1	RECORD	Enable output			ro
------	--------	---------------	--	--	----

Sub-indices

0	VAR	Number of entries	3	Unsigned8	ro
1	VAR	RS422	x	BOOL	rw
3	VAR	Analog out		BOOL	rw
4	VAR	Switching outputs		BOOL	rw

Corresponds to the OUTPUT command. Parallel output of measured values via the respective interface can be switched on and off.

A 6.4.2.23 Object 21C0h: Ethernet**Object 21C0h: Ethernet**

21C0	RECORD	Ethernet			ro
------	--------	----------	--	--	----

Sub-indices

0	VAR	Number of entries	4	Unsigned8	ro
1	VAR	IP address	xxx.xxx.xxx.xxx	Visible string	rw
2	VAR	Subnet mask	xxx.xxx.xxx.xxx	Visible string	rw
3	VAR	Gateway	xxx.xxx.xxx.xxx	Visible string	rw
4	VAR	DHCP	FALSE	BOOL	rw

For more information, please refer to the Ethernet IP Settings section, [see A 5.3.7.1](#).

DHCP:

- 0 - Static IP address
- 1 - DHCP

A 6.4.2.24 Object 21D0h: Analog output

21D0	RECORD	Analog output			ro
------	--------	---------------	--	--	----

Sub-indices

0	VAR	Number of entries	6	Unsigned8	ro
1	VAR	Analog output	x	Unsigned8	rw
2	VAR	Signal	x	Visible string	rw
3	VAR	Available signals		Visible string	ro
4	VAR	Type of scaling	x	Unsigned8	rw
5	VAR	Two-point-scaling start	x.x	FLOAT32	rw
6	VAR	Two-point-scaling end	x.x	FLOAT32	rw

For more information, please refer to the Analog Output section, [see A 5.3.15](#).

Analog output:

- 0 - voltage 0 ... 5 V
- 1 - voltage 0 ... 10 V
- 7 - current 4 ... 20 mA

Signal: Data can only be selected in accordance with the selected measuring program. For distance measurements, only distance 1 can be selected.

You can, for example, select 01DIST1. `Available signals` lists the available signals.

Type of scaling:

- 0 - default scaling
- 1 - two-point scaling

A 6.4.2.25 Object 21F3h: Switching output 1

21F3	RECORD	Analog output			ro
Sub-indices					
0	VAR	Number of entries	7	Unsigned8	ro
1	VAR	Output level		Unsigned8	rw
2	VAR	Error out		Unsigned8	rw
3	VAR	Limit signal		Visible string	rw
4	VAR	Available signals		Visible string	ro
5	VAR	Lower limit value		FLOAT32	rw
6	VAR	Upper limit value		FLOAT32	rw
7	VAR	Compare to		Unsigned8	rw

For more information, please refer to the Switching Output section, [see A 5.3.14](#).

Output level:

- 0 - PNP
- 1 - NPN
- 2 - Push-pull
- 3 - Push-pull negated

Error out:

- 1 - 01ER1
- 2 - 01ER2
- 3 - 01ER12
- 4 - 02ER1
- 5 - 02ER2
- 6 - 02ER12
- 7 - 0102ER12
- 8 - ERRORLIMIT

Use `Limit signal` to select a measured value signal that will be used for the comparison.

`Available signals` contains a list of the available signals.

Compare to:

- 1 - Lower
- 2 - Upper
- 3 - Both

Object 21F4h includes the settings for switching output 2.

A 6.4.2.26 Object 2250h: Exposure mode for channel 1

2250	RECORD	Shutter mode ch1			
Sub-indices					
0	VAR	Number of entries	3	Unsigned8	ro
1	VAR	Shutter mode	x	Unsigned8	rw
3	VAR	Shutter time 1	x.xx	FLOAT32	rw
4	VAR	Shutter time 2	x.xx	FLOAT32	rw

For more information, please refer to the Exposure Mode section, [see 6.2.6](#), the Exposure Mode section, [see A 5.3.9.4](#), and the Exposure Time section, [see A 5.3.9.6](#).

Shutter mode:

- 1 - Measuring mode
- 2 - Manual mode
- 3 - Two-time mode alternating
- 4 - Two-time mode automatic

Object 3250h includes the exposure settings for channel 2.

A 6.4.2.27 Object 2251h: Measuring rate

2251	RECORD	Measuring rate		FLOAT32	rw
------	--------	----------------	--	---------	----

For more information, please refer to the Measuring rate section, [see A 5.3.9.5](#).

A 6.4.2.28 Object 24A0h: Keylock

24A0	RECORD	Keylock			ro
------	--------	---------	--	--	----

Sub-indices

0	VAR	Number of entries	2	Unsigned8	ro
1	VAR	Mode	0	Unsigned8	rw
2	VAR	Delay	0	Unsigned16	rw

For more information, please refer to the Keylock section, [see A 5.3.16.3](#).

Mode:

- 0 - Inactive
- 1 - Active
- 2 - Automatic mode / Active after delay

A 6.4.2.29 Object 24A2h: Multi-function button

24A2	RECORD	Keyfunc			ro
------	--------	---------	--	--	----

Sub-indices

0	VAR	Number of entries	4	Unsigned8	ro
1	VAR	Function 1	0	Unsigned8	rw
2	VAR	Function 2	0	Unsigned8	rw
3	VAR	Signals for key mastering		Visible string	rw
4	VAR	Available signals		Visible string	ro

Function 1 and 2:

- 0 - Key has no function
- 1 - Triggers dark reference
- 2 - Mastering
- 3 - Turns the light source on/off

Sub-index 2 in the KEYFUNC command corresponds to the “signal”. When mastering via the (Function == 2) button, this entry specifies which signal is to be used for mastering.

A 6.4.2.30 Object 25A0h: Encoder

25A0	RECORD	Encoder			ro
Sub-indices					
0	VAR	Number of entries	10	Unsigned8	ro
1	VAR	Encoder 1 reference signal	x	Unsigned8	rw
2	VAR	Encoder 1 interpolation	x	Unsigned8	rw
3	VAR	Encoder 1 initial value	x	Unsigned32	rw
4	VAR	Encoder 1 maximum value	x	Unsigned32	rw
5	VAR	Encoder 1 set value	FALSE	BOOL	wo
6	VAR	Encoder 2 reference signal	x	Unsigned8	rw
7	VAR	Encoder 2 interpolation	x	Unsigned8	rw
8	VAR	Encoder 2 initial value	x	Unsigned32	rw
9	VAR	Encoder 2 maximum value	x	Unsigned32	rw
10	VAR	Encoder 2 set value	FALSE	BOOL	wo

For more information, please refer to the Encoder Inputs section, [see 6.1.2](#) and the Encoders section, [see A 5.3.6](#).

Encoder reference signal:

- 0 - None, the encoder's reference marker has no effect
- 1 - One, specified once
- 3 - Ever, specified for all markers

Encoder interpolation:

- 1 - Single interpolation
- 2 - Dual interpolation
- 3 - Quadruple interpolation

Encoder initial value:

0 ... $2^{32}-1$

Encoder maximum value:

0 ... $2^{32}-1$

A 6.4.2.31 Object 2711h: Masking the evaluation range for channel 1

2711	RECORD	Range of interest ch1			
Sub-indices					
0	VAR	Number of entries	2	Unsigned8	ro
1	VAR	Range of interest start	x	Unsigned16	rw
2	VAR	Range of interest end	x	Unsigned16	rw

For more information, please refer to the section on masking the evaluation range, [see 6.2.4](#), [see A 5.3.9.7](#).

Object 3711h includes the evaluation range for channel 2.

A 6.4.2.32 Object 2800h: Material information

2800	RECORD	Material info and edit			
Sub-indices					
0	VAR	Number of entries	7	Unsigned8	ro
1	VAR	Material name	xxxxx	Visible string	rw
2	VAR	Material description	xxxxxx	Visible string	rw
3	VAR	Type of refraction numbers	xx	Uint8	rw
4	VAR	nd	x.xxxx	FLOAT32	rw
5	VAR	nF	x.xxxx	FLOAT32	rw
6	VAR	nC	x.xxxx	FLOAT32	rw
7	VAR	Abbe number	x.xxxx	FLOAT32	rw

For more information, please refer to the Material Database section, [see 6.2.9](#), [see A 5.3.10](#).

Material name: Currently selected material for a thickness measurement

Material description: Description of the currently selected material

nd, nf and nC: Refractive index of the currently selected material at 587 nm, 486 nm and 656 nm

Abbe number: Abbe number for the currently selected material

The current material can be edited in Expert mode. Specified settings are stored immediately.

A 6.4.2.33 Object 2802h: Edit material table

2802	RECORD	Material table edit			
Sub-indices					
0	VAR	Number of entries	4	Unsigned8	ro
1	VAR	Material delete	x	Visible string	wo
2	VAR	Reset materials	x	BOOL	wo
3	VAR	New material	x	BOOL	wo
4	VAR	Select material for edit		Visible string	wo

Material delete: Specify the name of a material to be deleted from the material table

Reset materials: Resets the material table to the factory settings

New material: Creates a new material in the material table. The newly created material ("NewMaterial") is edited in object 2800h "Material info".

Sub-index 4 selects the material that is to be edited in object 0x2800.

A 6.4.2.34 Object 2803h: Existing materials

2803	RECORD	Material table			
Sub-indices					
0	VAR	Number of entries	1	Unsigned8	ro
1	VAR	Material names list	"xx" "xx" ...	Visible string	ro

Provides a list of all available materials.

A 6.4.2.35 Object 2804h: Select material for channel 1

2804	RECORD	Material selection ch1			
Sub-indices					
0	VAR	Number of entries	5	Unsigned8	ro
1	VAR	Material 1	xx	Visible string	rw
2	VAR	Material 2	xx	Visible string	rw
3	VAR	Material 3	xx	Visible string	rw
4	VAR	Material 4	xx	Visible string	rw
5	VAR	Material 5	xx	Visible string	rw

Material 1 to 5:

Specifies the material between distances 1 - 2, 2 - 3, 3 - 4, 4 - 5 and 5 - 6. The selected material needs to be available in the material table.

Object 3804h includes the material selection for channel 2.

A 6.4.2.36 Object 2A00h: Mastering

2A00	RECORD	Master 1			
Sub-indices					
0	VAR	Number of entries	5	Unsigned8	ro
1	VAR	Enable	xx	BOOL	rw
2	VAR	Signal	xx	Visible string	rw
3	VAR	Available signals	xx	Visible string	ro
4	VAR	Set/reset	xx	BOOL	rw
5	VAR	Value	xx	FLOAT32	rw

Masters or sets to zero a signal; there are 10 such objects (2A00h to 2A09h). References the MASTERSIGNAL command. The sub-index specifies which signal is to be mastered. Sub-index 3 corresponds to the META_MASTERSIGNAL command. Sub-index 4 corresponds to the MASTER command.

A 6.4.2.37 Object 2A10h: Statistics

2A10	RECORD	Statistic 1			
Sub-indices					
0	VAR	Number of entries	6	Unsigned8	ro
1	VAR	Enable		BOOL	rw
2	VAR	Signal		Visible string	rw
3	VAR	Available signals		Visible string	ro
4	VAR	Infinite		BOOL	rw
5	VAR	Depth		Unsigned32	rw
6	VAR	Reset		BOOL	rw

The objects 2A10h to 2A19h generate 10 statistics signals.

Sub-index 3 corresponds to the META_STATISTICSIGNAL command.

Sub-index 6 corresponds to the STATISTIC command.

3 signals are generated for each activated statistics object. These signals are listed in object 0x2E00. The statistics function can also be applied to user signals.

Example: You want distance 1 (channel 1) to output the minimum and the maximum measured values using all previous distance values.

- Activating a statistics object
2A10:01(Enable) to TRUE. Distance 1 (01DIST1) is selected as signal by default. If you would like to display statistics for a different signal, you will need to select the required signal in sub-index 2.
- Settings for all previous distance values
2A10:04 (Infinite) to True (STATISTICSIGNAL – INFINITE)

Associating a user-defined signal with the PDO

The newly generated signal names appear in object 0x2E00h:

2E00:0	User calc	RO	> 60 <			
2E00:01	User calc 01	RO	01DIST1_MIN		7C00:0	UserCalcOutput01 RO > 1 <
2E00:02	User calc 02	RO	01DIST1_PEAK		7C01:0	UserCalcOutput02 RO > 1 <
2E00:03	User calc 03	RO	01DIST1_MAX		7C02:0	UserCalcOutput03 RO > 1 <
2E00:04	User calc 04	RO			7C03:0	UserCalcOutput04 RO > 1 <
2E00:05	User calc 05	RO			7C04:0	UserCalcOutput05 RO > 1 <
2E00:06	User calc 06	RO			7C05:0	UserCalcOutput06 RO > 1 <
2E00:07	User calc 07	RO			7C06:0	UserCalcOutput07 RO > 1 <
2E00:08	User calc 08	RO			7C07:0	UserCalcOutput08 RO > 1 <
2E00:09	User calc 09	RO			7C08:0	UserCalcOutput09 RO > 1 <
2E00:0A	User calc 10	RO			7C09:0	UserCalcOutput10 RO > 1 <

The minimum distance is output in 0x7C00h and the maximum distance is output in 0x7C02h.

Select PDO

UserCalcOutput01 – 0x7C00h is selected with object 1B00h, and 0x7C02h is output with object 1B10h

1B00	UserCalc01 TxPDOMap	
	UserCalcOutput01	0x7C00
1B08	UserCalc02 TxPDOMap	
	UserCalcOutput02	0x7C01
1B10	UserCalc03 TxPDOMap	
	UserCalcOutput03	0x7C02

Extract from TxPDO Mapping

Therefore, the following selections need to be made in 0x1C13h, 0x1B00h and 0x1B10h before PreOp is switched to SafeOp:

0x00 (0)1B00	clear sm pdos (0x1C13)
0x1B00 (6912)	download pdo 0x1C13:01 index
0x1B10 (6928)	download pdo 0x1C13:02 index
0x02 (2)	download pdo 0x1C13 count

A 6.4.2.38 Object 2C00h: Measured value calculation for channel 1

2C00	RECORD	Comp y ch1			
Sub-indices					
0	VAR	Number of entries	8	Unsigned8	ro
1	VAR	Type		Unsigned16	rw
2	VAR	Name1		Visible string	rw
4	VAR	Signal1		Visible string	rw
5	VAR	Signal2		Visible string	rw
12	VAR	Available signals		???	ro
13	VAR	Factor1		FLOAT32	rw
14	VAR	Factor2		FLOAT32	rw
17	VAR	Offset		Integer32	rw
18	VAR	Param1		Unsigned32	rw

The Objects 2C00h to 2C09h generate 10 calculation modules for a channel.

The Objects 3C00h to 3C09 contain 10 calculation modules for channel 2.

The Objects 2CC0h to 2CC9 contain 10 calculation modules for computation of signals from both channels (IFC2422 / IFC2466 only).

Type:

- 1 - Moving average (MOVING)
- 2 - Recursive average (RECURSIVE)
- 3 - Median (MEDIAN)
- 4 - Calculating two signals (CALC)

As soon as the type is changed, default settings are loaded for the selected type. You can only select signals from the corresponding channel.

Depending on the type, all other object entries have different meanings:

- Moving average (MOVING):

4	Signal1	Signal to which the filter will be applied (default ch x: 0xDIST1)
18	Param1	Averaging number (default ch x: 2)

Value range for Param1: 2|4|8|16|32|64|128|256|512|1024|2048|4096

- Recursive average (RECURSIVE):

4	Signal1	Signal to which the filter will be applied (default ch x: 0xDIST1)
18	Param1	Averaging number (default ch x: 2)

Value range for Param1: 2 ... 32000

- Median (MEDIAN)

4	Signal1	Signal to which the filter will be applied (default ch x: 0xDIST1)
18	Param1	Averaging number (default chx/sys: 3)

Value range for Param1: 3|5|7|9

- Calculating two signals (CALC)

2	Name	Name of the generated signal
4	Signal1	(default ch x: 0xDIST1, default sys: 01DIST1)
5	Signal2	(default ch x: 0xDIST2, default sys: 02DIST1)
13	Factor1	(default chx/sys: -1.0)
14	Factor2	(default chx/sys: 1.0)
18	Offset	(default chx/sys: 0.0)

(<factor1> * <signal1>) + (<factor2> * <signal2>) + <offset>

Value range for offset (mm): -2147.0 ... 2147.0

- The object index determines the processing sequence and corresponds to the ID parameter for the ASCII command.

Example: Signal 01DIST1 is to be filtered using a median filter and an average value filter. The sequence is first median filter, then average value filter.

0x2C00:

1	Type	3 (Median)
4	Signal1	01DIST1
18	Param1	<Averaging number>

0x2C01:

1	Type	2 (Recursive average)
4	Signal1	01DIST1
18	Param1	<Averaging number>

Filters can also be applied to user signals.

A 6.4.2.39 Object 2CBFh: Sys Signals

2CBF	RECORD	Sys signals			
------	--------	-------------	--	--	--

Sub-indices

0	VAR	Number of entries	2	Unsigned8	ro
1	VAR	Range lower		FLOAT32	rw
2	VAR	Range upper		FLOAT32	rw

References the SYSSIGNALRANGE command.

A 6.4.2.40 Object 2E00: User signals

2E00	RECORD	User calc			
------	--------	-----------	--	--	--

Sub-indices

0	VAR	Number of entries	60	Unsigned8	ro
1	VAR	User calc 01		Visible string	ro
2	VAR	User calc 02		Visible string	ro
...					
3C	VAR	User calc 60		Visible string	ro

Names of the user signals that are output in the 0x7C0xh objects. The sequence specifies the order of the PDO data. The PDOs are selected via the 0x1B0xh objects.

A 6.5 Mappable objects – process data

Displays all individually available process data.

The objects 0x600x, 0x680x, 0x700x and 0x7C0x are structured as follows:

[INDEX]		[NAME]			
	0	Sub-index 0	Uint8	READ	1 (fix)
	1	Sub-index 1	[DATA TYPE]	READ	-

Table 3

Objects 0x6000: Process data for channel 1

Objects 0x6800: Process data for channel 2, only available with IFC2422 / IFC2466

Objects 0x7000: System process data (process data that are not available per channel)

Objects 0x7C00: Calculated process data

The names of the objects are based on the names of potential parameters for the OUT_ETH command.

- The process data for the objects are not yet available after switching on. Only a successful state change from PreOP to SafeOP makes the process data available which were selected through object 0x1C13h or the mapping objects for the PDO output. If the state changes from SafeOP to OP, all previously selected process data are still available.

CH0x: Channel/sensor x;
x = {1, 2}

DISTy: Distance y;
y = {1, 2, ..., 6}

INDEX	NAME	INDEX	NAME	[DATA TYPE]
6000	CH01DIST1	6800	CH02DIST1	INT32
6001	CH01DIST2	6801	CH02DIST2	INT32
6002	CH01DIST3	6802	CH02DIST3	INT32
6003	CH01DIST4	6803	CH02DIST4	INT32
6004	CH01DIST5	6804	CH02DIST5	INT32
6005	CH01DIST6	6805	CH02DIST6	INT32
6010	CH01INTENSITY1	6810	CH02INTENSITY1	UINT32
6011	CH01INTENSITY2	6811	CH02INTENSITY2	UINT32
6012	CH01INTENSITY3	6812	CH02INTENSITY3	UINT32
6013	CH01INTENSITY4	6813	CH02INTENSITY4	UINT32
6014	CH01INTENSITY5	6814	CH02INTENSITY5	UINT32
6015	CH01INTENSITY6	6815	CH02INTENSITY6	UINT32
6020	CH01UNLIN1	6820	CH02UNLIN1	UINT32
6021	CH01UNLIN2	6821	CH02UNLIN2	UINT32
6022	CH01UNLIN3	6822	CH02UNLIN3	UINT32
6023	CH01UNLIN4	6823	CH02UNLIN4	UINT32
6024	CH01UNLIN5	6824	CH02UNLIN5	UINT32
6025	CH01UNLIN6	6825	CH02UNLIN6	UINT32
6030	CH01SHUTTER	6830	CH02SHUTTER	UINT32
6050	CH01ENCODER1	6850	CH02ENCODER1	UINT32
6051	CH01ENCODER2	6851	CH02ENCODER2	UINT32
7000	COUNTER			UINT32
7001	TIMESTAMP			UINT32
7002	FREQUENCY			UINT32
7C00	UserCalcOutput01			INT32
7C01	UserCalcOutput02			INT32
...
7C3B	UserCalcOutput60			INT32

Fig. 97 Mappable Objects

A 6.6 Error codes for SDO services

If an SDO requirement is evaluated as negative, a corresponding error code is added to the “Abort SDO Transfer Protocol”.

Hexadecimal error code	Meaning
0503 0000	Toggle bit did not change
0504 0000	SDO protocol timeout expired
0504 0001	Invalid command entered
0504 0005	Insufficient memory
0601 0000	Access to object (parameter) not supported
0601 0001	Attempt to read a “write-only parameter”
0601 0002	Attempt to write a “read-only parameter”
0602 0000	Object (parameter) is not listed in the object directory
0604 0041	Object (parameter) cannot be mapped to PDO
0604 0042	Number or length of the transfer objects exceeds the PDO length
0604 0043	General parameter incompatibility
0604 0047	General internal device incompatibility
0606 0000	Access denied due to a hardware error
0607 0010	Incorrect data type or length of the service parameter does not match
0607 0012	Incorrect data type or the service parameter is too long
0607 0013	Incorrect data type or the service parameter is too short
0609 0011	Sub-index does not exist
0609 0030	Invalid value for the parameter (only for write access)
0609 0031	Value of parameter too high
0609 0032	Value of parameter too low
0609 0036	Maximum value is below minimum value.
0800 0000	General error
0800 0020	Unable to transfer data to the application or unable to store data
0800 0021	Unable to transfer data to the application or unable to store data. Cause: local control
0800 0022	Unable to transfer data to the application or unable to store data. Cause: device state
0800 0023	Dynamic generation of the object directory failed or no object directory available

A 6.7 Oversampling

In operation without oversampling, the last acquired data record containing measured values is transmitted to the EtherCAT Master with each fieldbus cycle, see A 6.4.1.7. Therefore, for long fieldbus cycle periods many data records with measured values are not available. Configurable oversampling ensures that all (or selected) measured value data records are gathered and transmitted together to the master during the next fieldbus cycle.

The oversampling factor specifies how many samples per bus cycle are transmitted. For example, an oversampling factor of 2 means that 2 samples are transferred per bus cycle.

With TxPDO Mapping, see Fig. 96, the base index of the PDO mapping objects is included with the oversampling factor 1. Use the following list to determine the index for selecting a different oversampling factor:

- Base index + 1: Oversampling factor 2
- Base index + 2: Oversampling factor 4
- Base index + 3: Oversampling factor 8

You can only select mapping objects with the same oversampling factor in 0x1C13h.

Example:

- The fieldbus/EtherCAT master operates at a cycle time of 1 ms because the higher-level PLC works with a cycle time of 1 ms. This means that every 1 ms, an EtherCAT frame is sent to the IFC2421/2422/2465/2466 to pick up process data. If the measuring frequency is set to 4 kHz, you need to specify an oversampling of 4.
- Startup procedure to output distance 1 for channel 1 (01DIST1) and distance 2 for channel 1 (01DIST2) with an oversampling factor of 4.
 - Set the object peak count 2156:01h to 2 in order to get two distances.
 - Distance 1 for channel 1 is output in object 6000h. In order to transfer this object in the PDO, the PDO mapping object 0x1A00 must be selected in object 0x1C13:01h. However, 0x1A02 (base index 0x1A00 + 2) must be selected for the 4-fold oversampling.

+	1A01:0	Ch01Dist1 TxPDOMap OV2	RO	> 2 <
-	1A02:0	Ch01Dist1 TxPDOMap OV4	RO	> 4 <
	1A02:01	Subindex 001	RO	0x6000:01, 32
	1A02:02	Subindex 002	RO	0x6000:01, 32
	1A02:03	Subindex 003	RO	0x6000:01, 32
	1A02:04	Subindex 004	RO	0x6000:01, 32
+	1A03:0	Ch01Dist1 TxPDOMap OV8	RO	> 8 <

- Distance 2 for channel 1 is output in object 6001h. In order to transfer this object in the PDO, the PDO mapping object 0x1A10 must be selected in object 0x1C13:02h. However, 0x1A12 (base index 0x1A10 + 2) must be selected for the 4-fold oversampling.

Sync Manager:

SM	Size	Type	Flags
0	256	MbxOut	
1	256	MbxIn	
2	0	Outputs	
3	32	Inputs	

PDO Liste:

Index	Size	Name
0x1A00	4.0	Ch01Dist1 OV1
0x1A01	8.0	Ch01Dist1 OV2
0x1A02	16.0	Ch01Dist1 OV4
0x1A03	32.0	Ch01Dist1 OV8
0x1A08	4.0	Ch02Dist1 OV1
0x1A09	8.0	Ch02Dist1 OV2
0x1A0A	16.0	Ch02Dist1 OV4
0x1A0B	32.0	Ch02Dist1 OV8
0x1A10	4.0	Ch01Dist2 OV1
0x1A11	8.0	Ch01Dist2 OV2
0x1A12	16.0	Ch01Dist2 OV4
0x1A13	32.0	Ch01Dist2 OV8
0x1A18	4.0	Ch02Dist2 OV1

PDO Zuordnung (0x1C13):

- 0x1A00 (excluded by 0x1A02)
- 0x1A01 (excluded by 0x1A02)
- 0x1A02
- 0x1A03 (excluded by 0x1A02)
- 0x1A08
- 0x1A09
- 0x1A0A
- 0x1A0B
- 0x1A10 (excluded by 0x1A12)
- 0x1A11 (excluded by 0x1A12)
- 0x1A12
- 0x1A13 (excluded by 0x1A12)

Download

PDO Zuordnung

PDO Konfiguration

PDO Inhalt (0x1A00):

Index	Size	Offs	Name
0x6000:01	4.0	0.0	CH01DIST
		4.0	

Predefined PDO Assignment: (keine)

Lade PDO Info aus dem Gerät

Sync Unit Zuordnung...

To ensure that no samples are lost due to the asynchronous nature between the master cycle and slave cycle, the master cycle time should always be less than the time for building a block from n samples.

An entire block with the specified samples is only made available to the EtherCAT side after all specified samples have been written to the block. If the time for filling a block is less than the master cycle time, individual blocks are not transferred. It can indeed happen that the next block is already being filled with samples before the previously filled block is picked up in a master cycle.

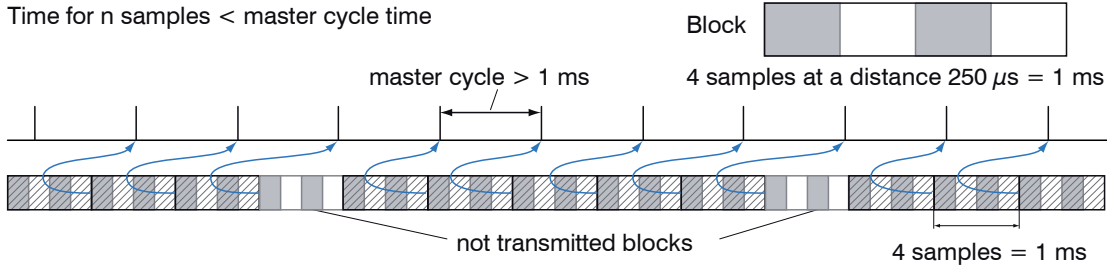

But if you select a number of samples sufficiently large so that the time for filling a block is greater than the master cycle time, each block will be picked up in a master cycle. Individual blocks (and therefore samples), however, will be transferred two or more times. This can be detected on the master side by transferring the timestamp or value counter (see object 0x21B0).

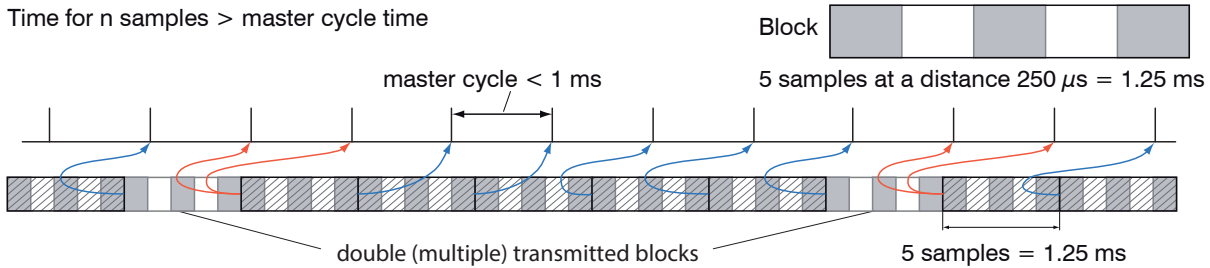

A 6.8 Calculations

A 6.8.1 Setting a filter

The function for an average or median filter has been explained, see A 6.4.2.38.

A 6.8.2 Thickness calculation

Sequence for outputting a thickness (distance 1 to distance 2) in the PDO:

Steps 1 and 2 are not required when using the `Single side thickness` preset. To activate this preset, `Single side thickness` must be written to object 2012:03h, see A 6.4.2.6. Please note that this also modifies other settings.

➤ Step 1: Set the number of expected peaks to 2.

2156:0	Multilayer options ch 1	RO	> 2 <
2156:01	Peak count	RW	0x02 (2)
2156:02	Disable refractivity correction	RW	FALSE

➤ Step 2: Set up the calculation for object 2C00:

Set sub-index 1 to 4h. The name for the generated signal is `THICK12`.

Formula for the calculation: $THICK12 = -1.0 \times 01DIST1 + 1.0 \times 01DIST2 + 0.0$

The factors and the offset must be defined accordingly:

2C00:0	Comp 1 ch1	RO	> 25 <
2C00:01	Type	RW	0x0004 (4)
2C00:02	Name	RW	THICK12
2C00:03	Signal1	RW	01DIST1
2C00:04	Signal2	RW	01DIST2
2C00:0D	Factor1	RW	-1.000000 (-1.000000e+000)
2C00:0E	Factor2	RW	1.000000 (1.000000e+000)
2C00:17	Offset	RW	0.000000 (0.000000e+000)
2C00:18	Param 1	RW	0x00000000 (0)

➤ Step 3: Assigning a user-defined signal to a PDO

2E00h now includes the new signal name (all user-defined signals are displayed starting with sub-index 1).

2E00:0	User calc	RO	> 40 <
2E00:01	User calc 01	RO	THICK12
2E00:02	User calc 02	RO	
2E00:03	User calc 03	RO	
2E00:04	User calc 04	RO	
2E00:05	User calc 05	RO	
2E00:06	User calc 06	RO	
2E00:07	User calc 07	RO	
2E00:08	User calc 08	RO	
2E00:09	User calc 09	RO	
2E00:0A	User calc 10	RO	
7C00:0	UserCalcOutput01	RO	> 1 <
7C01:0	UserCalcOutput02	RO	> 1 <
7C02:0	UserCalcOutput03	RO	> 1 <
7C03:0	UserCalcOutput04	RO	> 1 <
7C04:0	UserCalcOutput05	RO	> 1 <
7C05:0	UserCalcOutput06	RO	> 1 <
7C06:0	UserCalcOutput07	RO	> 1 <
7C07:0	UserCalcOutput08	RO	> 1 <
7C08:0	UserCalcOutput09	RO	> 1 <
7C09:0	UserCalcOutput10	RO	> 1 <

➤ Step 4: Select the PDO.

UserCalcOutput01 – 0x7C00h is selected with 0x1B00h:

1B00	UserCalc01 TxPDOMap
	UserCalcOutput01
	0x7C00
1B08	UserCalc02 TxPDOMap

Before PreOp is changed to SafeOp, the following must be selected in 0x1C13h and 0x1B00h:

0x1C13:00	0x00 (0)	clear sm pdos (0x1C13)
0x1C13:01	0x1B00 (6912)	download pdo 0x1C13:01 index
0x1C13:00	0x01 (1)	download pdo 0x1C13 count

A 6.8.3 Channel calculation

A channel calculation can only be performed with controller IFC2422 / IFC2466. The thickness calculation principles apply, see A 6.8.2. The calculation itself, however, is performed in object 0x2CC0h.

A 6.9 Operational modes

A 6.9.1 Free run

There is no synchronization. The PDOs are updated in line with the internal measuring rate. The measuring rate is set using object 0x2251h.

Use the measured value counter in 0x7000h or 0x1AE0h to ensure that no measured values are evaluated twice due to the lack of synchronization.

A 6.9.2 Distributed clocks SYNC0 synchronization

The measuring rate is determined by the SYNC0 cycle time. In this mode, an EtherCAT master can synchronize the measured value acquisition for the EtherCAT cycle time and the measured value acquisition for multiple controllers.

The ESI-XML file includes predefined SYNC0 cycle times. But you can set any cycle time between 153846 ns (measuring rate=6.5 kHz; IFC2421/2422) resp. 33333 ns (measuring rate=30 kHz; IFC2465/2466) and 10,000,000 ns (measuring rate=0.1 kHz).

A 6.10 Video signal via SDO

The output of the video signal for channel 1 is activated via object 0x2142:1h and the output of the video signal for channel 2 via object 0x3142:1.

Every time a video image is triggered via object 0x2141:2h, objects 0x8000h (channel 1) and 0x8800 (channel 2) store the new image data. The data are provided as 1024-byte octet strings. On the side of the EtherCAT master, the data need to be interpreted as vector of 16-bit unsigned integers.

The output of the video signal can be parallel to the PDO output of process data. The process data in objects 0x6000h to 0x7FFFh will no longer be updated cyclically once a video signal has been activated. Instead, updates will be triggered by video images. This ensures that each video image can be associated with the distance value that is calculated for this image.

A 6.11 STATUS LEDs in EtherCAT operation

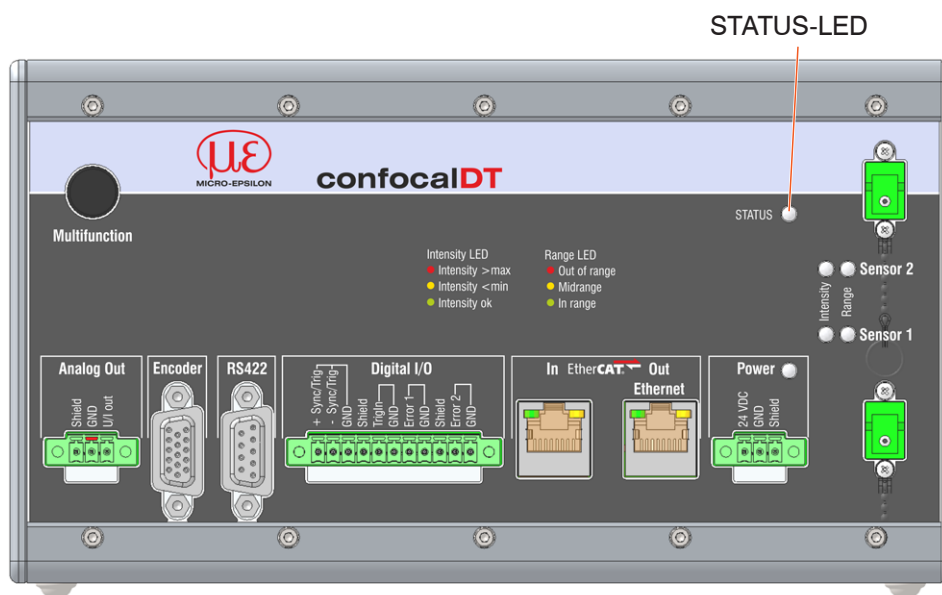

Status LED	Green state:	
	Green off	INIT state
	Green flashing 2.5 Hz	PRE-OP state
	Green single flash, 200 ms ON / 1000 ms OFF	SAFE-OP state
	Green on	OP state
	Red faults (displayed while green LED pauses):	
	Red off	No fault
	Red flashing 2.5 Hz	Invalid configuration
	Red single flash, 200 ms ON / 1000 ms OFF	Unrequested change of state
	Red double flash, 200 ms ON / 200 ms OFF 200 ms ON 400 ms OFF	Watchdog timeout
	Red flashing 10 Hz	Error during initialization

A 6.12 EtherCAT configuration with the Beckhoff TwinCAT® Manager

An example for an EtherCAT master on the PC is the Beckhoff TwinCAT Manager.

- Before you can use EtherCAT for the controller, the controller must be configured for EtherCAT operation, see A 6.2.

The device description file (EtherCAT®-Slave Information) IFC242x.xml resp. IFC246x.xml can be found online at www.micro-epsilon.com/service/download/software/.

- Copy the device description file to the directory C:\TwinCAT\3.1\Config\Io\EtherCAT before the measuring device can be configured via EtherCAT®.
- Delete any existing older files.

EtherCAT® slave information files are XML files that specify the properties of the slave device for the EtherCAT® master. They contain information about the supported communication objects.

- Restart the TwinCAT manager after the copy operation.

Searching for a device:

- Select the I/O Devices tab and then select Scan.
- Confirm with OK.

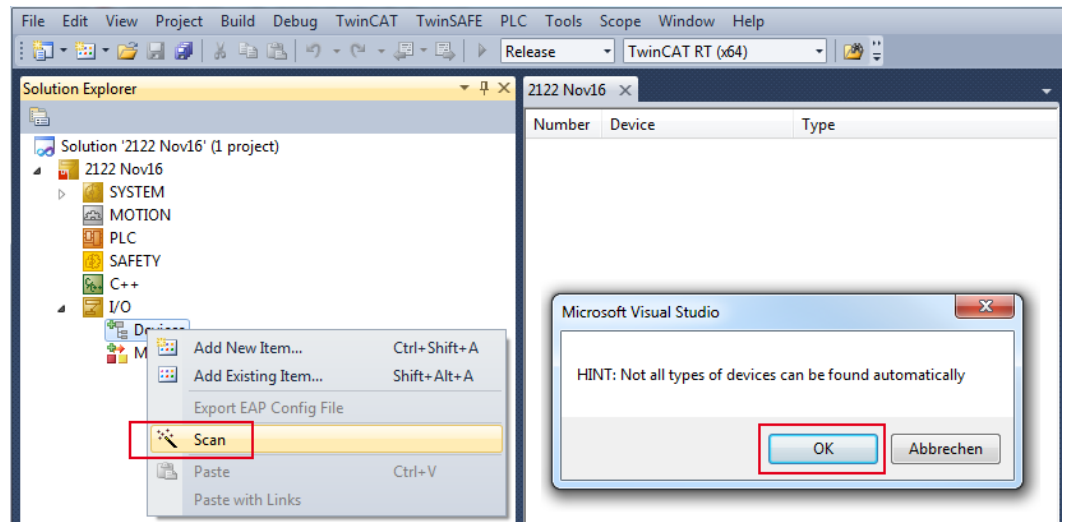

➔ Select a network card which will be searched for EtherCAT® slaves.

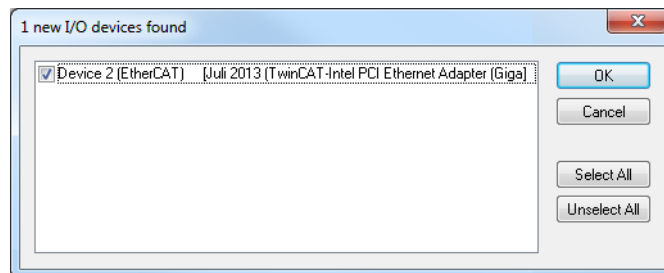

➔ Confirm with OK.

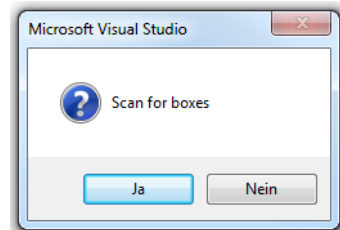

The "Scan for boxes" window appears (EtherCAT® slaves).

➔ Confirm with Yes.

The confocalDT 2421/2422/2465/2466 is now included in a list.

➔ Acknowledge the Activate Free Run window with Yes.

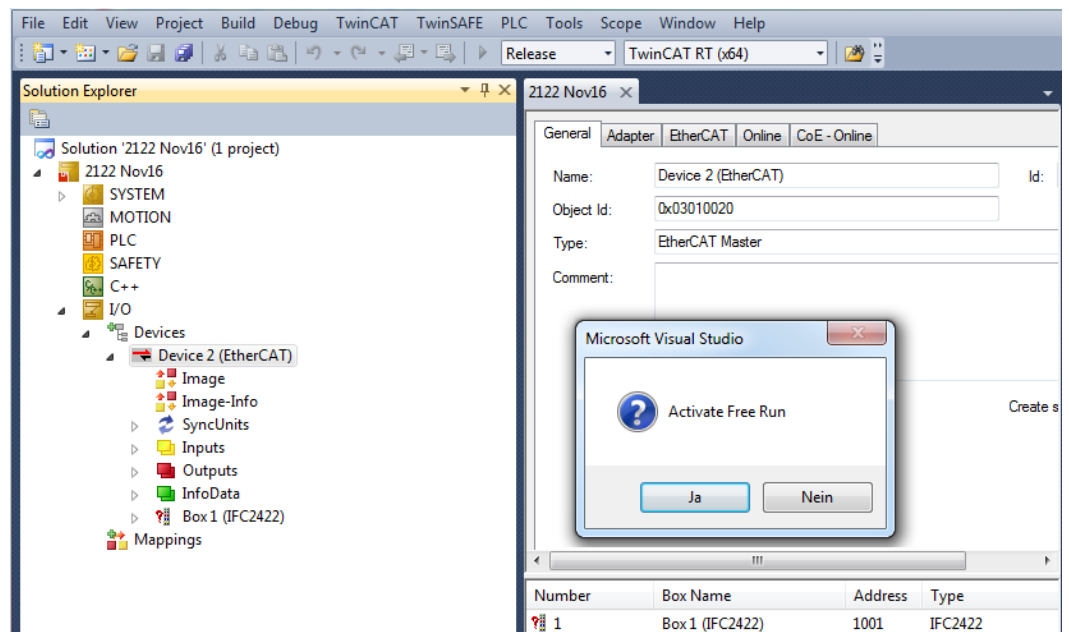

The current status on the online side should at least indicate PREOP, SAFEOP or OP.

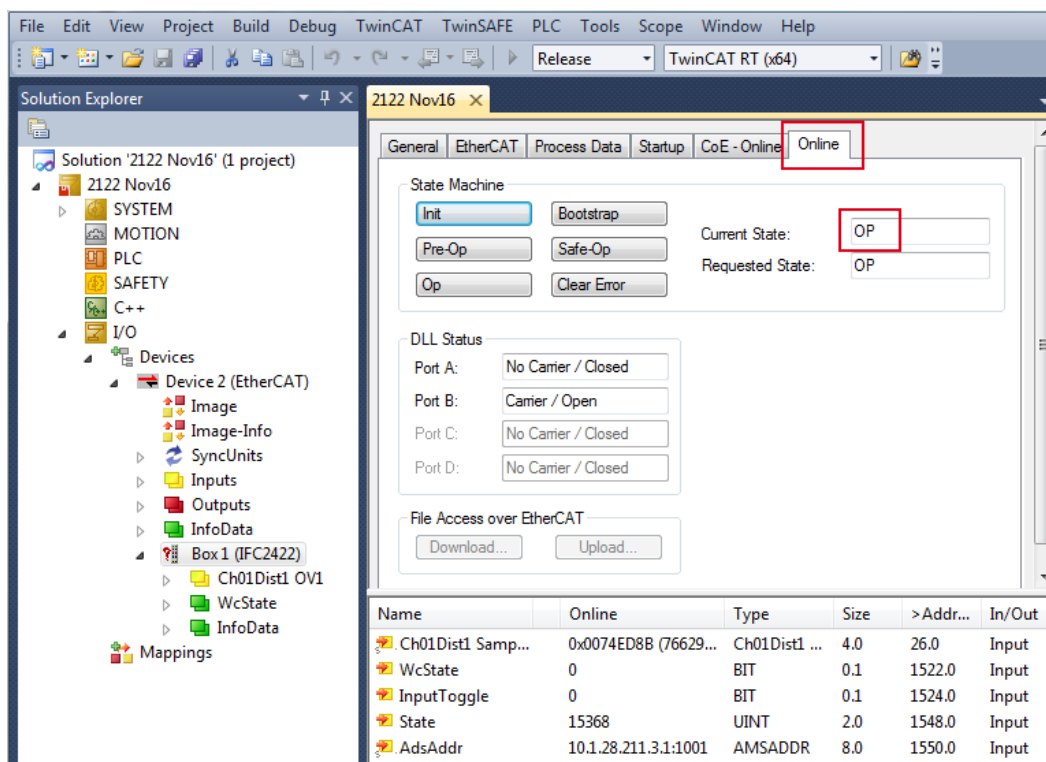

In the event that ERR PREOP appears in Current Status, the cause is reported in the message window. This is the case if the PDO mapping settings in the controller are different from the settings in the ESI file (confocalDT24XX.xml).

The factory settings specify only one measurement (distance 1) as output value (both in the controller and in the ESI file).

You can select additional data on the Process Data tab.

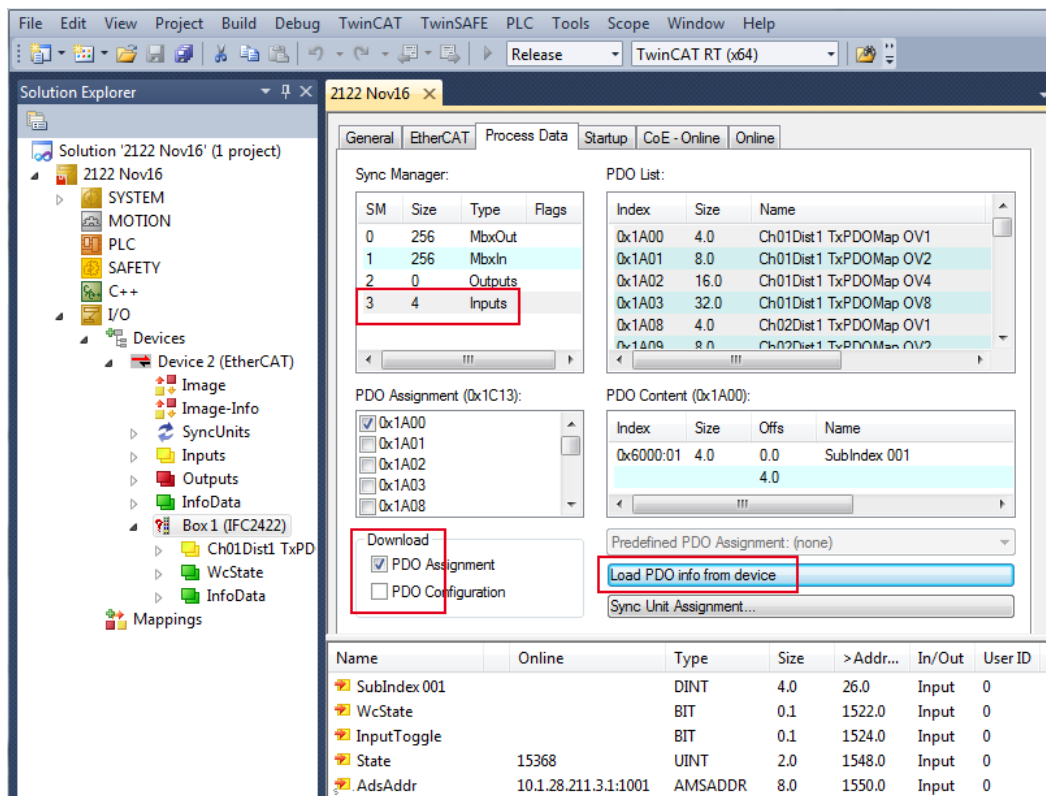

You can now view the scope of available process data and the assignment of sync managers.

➡ From the TwinCAT menu select the Restart TwinCAT (Config Mode) tab.

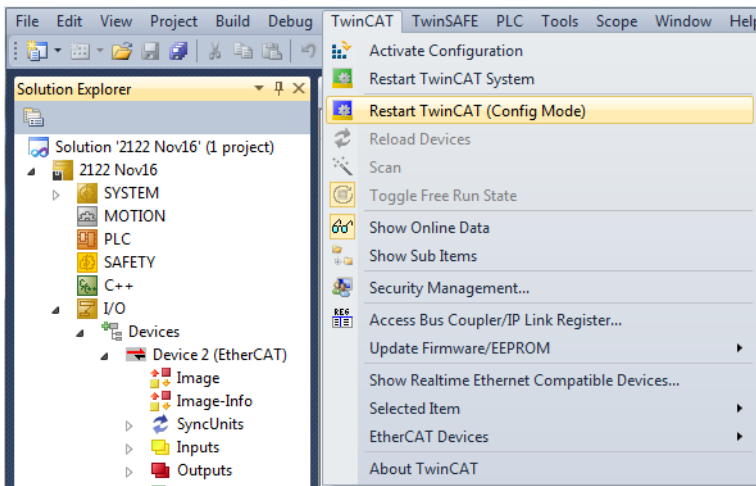

Configuration is now complete.

In the SAFEOP and OP states, the selected measurements are transmitted as process data.

The screenshot shows the TwinCAT software interface with a table of device data. The table has columns for Name, Online, Type, Size, >Addr..., In/Out, and User ID. The 'Online' column for 'SubIndex 001' is highlighted with a red box, showing the value '10345664'. The 'Solution Explorer' on the left shows the project structure, with 'Box 1 (IFC2422)' expanded to show 'Ch01Dist1 TxPD' and 'WcState'.

Name	Online	Type	Size	>Addr...	In/Out	User ID
SubIndex 001	10345664	DINT	4.0	26.0	Input	0



MICRO-EPSILON MESSTECHNIK GmbH & Co. KG
Koenigbacher Str. 15 · 94496 Ortenburg / Germany
Tel. +49 (0) 8542 / 168-0 · Fax +49 (0) 8542 / 168-90
info@micro-epsilon.com · www.micro-epsilon.com
Your local contact: www.micro-epsilon.com/contact/worldwide/

X9751367-B022113MSC
© MICRO-EPSILON MESSTECHNIK