

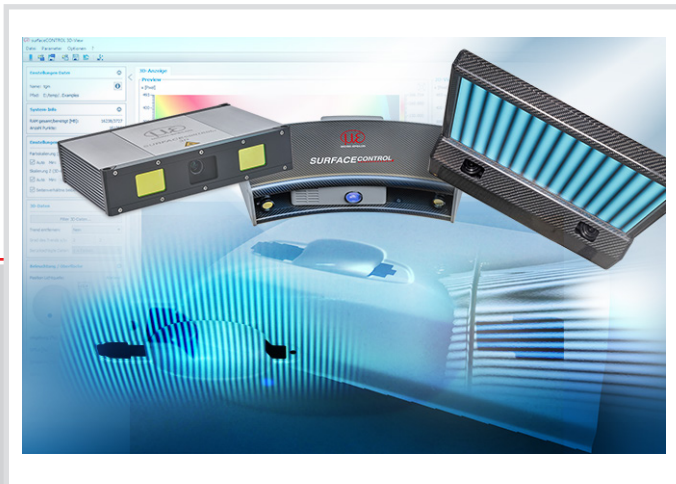

Instruction Manual



3DInspect 1.6

MICRO-EPSILON
MESSTECHNIK
GmbH & Co. KG
Koenigbacher Str. 15

94496 Ortenburg / Germany

Tel. +49 (0) 8542 / 168-0
Fax +49 (0) 8542 / 168-90
e-mail: info@micro-epsilon.com
www.micro-epsilon.com

Inhalt

1.	Introduction	6
1.1	Using this Manual	6
1.2	Overview of the Complete System	7
1.3	Definition of Basic Terms	8
1.4	Operating Modes	8
1.5	Functions of the Measuring Programs	8
2.	Installation and Preparation for Measurement Operation	11
2.1	Installation Requirements	11
2.2	Installation of the Software.....	11
2.3	Connecting the Sensor to the PC	12
3.	Working with 3DInspect	13
3.1	Launching 3DInspect.....	13
3.2	Overview Description	13
3.3	Steps for Setting the Parameters for a Measuring Task	14
3.4	Online Mode	14
3.4.1	Description of the "Sensor Settings" Box (reflectCONTROL)	15
3.4.2	Make Reference Measurements (reflectCONTROL)	17
3.4.3	Description of the "Sensor Settings" Box (surfaceCONTROL)	20
3.4.4	Description of the "Sensor Settings" Box (scanCONTROL 30XX)	21
3.4.5	Description of the "Sensor Settings" Box (ProfileUnit)	23
3.4.6	Description of the "Resolution / Measuring field" Dialog Box	25
3.4.7	Description of the "Advanced Sensor Settings" Dialog Box	26
3.4.8	Measurement wizard.....	26
3.5	Offline Mode.....	27
3.5.1	Description of the "File Settings" Box	27
3.6	Saving Point Clouds	30
3.6.1	Saving Point Clouds / 2D Measurement Data / Camera Images manually.....	30
3.6.2	Saving Point Clouds automatically	31
3.7	Description of the Status Display.....	31
3.8	Description of the "Display Settings" Box	32
3.9	Description of the "3D Data" Box	33
3.10	Description of the "Lighting / Surface" Box	34
3.11	Description of the 3D-View	34
3.12	3D-View Settings.....	37
3.13	Description of the 2D Profile View	40
3.14	Structure of a Measuring Program	42
3.15	Adding/Removing Measuring Programs	43
3.16	Moving/Duplicating a Measuring Program	44
3.17	Adding/Removing Measuring Program Groups	45
3.18	Configuring a Measuring Program	46
3.18.1	Renaming a Measuring Program.....	46
3.18.2	Specifying a Measuring Task.....	46
3.18.3	Selecting Input Data	47
3.18.4	Selecting 3D Points.....	47
3.18.5	Selecting 2D Points.....	50
3.18.6	Resetting the Region of Interest	52
3.18.7	Adding/Removing Region of Interests	52
3.18.8	Setting the Parameters for a Measuring Program	52
3.18.9	Selecting Measured Values to be Used Further	53
3.19	Measuring Program Output Data.....	53
3.19.1	Points	53
3.19.2	Straight Line	54
3.19.3	Plane	54
3.19.4	Circle	54

3.20	Saving and Loading Parameters	56
3.20.1	Saving Parameters to File	56
3.20.2	Loading Parameters from File	56
3.20.3	Resetting Parameters to Factory Default	57
3.21	Undo/Restore	57
3.22	User management	57
3.23	Menu Bar	58
3.24	Functions of the "General" Toolbar	61
3.25	Basic Settings	62
3.26	Adjusting Sensor Network Settings (Ethernet Configurator)	65
3.27	Exiting 3DInspect	66
4.	Description of the "Data Acquisition" View	67
4.1	Description of the "Display Image Data" Tab	68
4.1.1	Description of the "Display Image Data" Tab (surfaceCONTROL/reflectCONTROL)	68
4.1.2	Description of the "Display Image Data" Tab (scanCONTROL 30XX)	70
4.1.3	Description of the "Display Image Data" Tab (ProfileUnit)	72
4.2	Description of the "2D-Images" Tab	74
4.3	Description of the "Sensor Configuration" Tab (ProfileUnit)	76
4.4	Description of the "3D-View" Tab	78
4.4.1	Description of the Preview Window	79
4.4.2	Description of the 2D-View	79
4.5	Description of the "2D-View" Tab (ProfileUnit)	81
5.	Description of the "Data Preprocessing" View	82
5.1	Description of the Measuring Programs in the "Data Preprocessing" Group	84
5.1.1	"Position Correction" Measuring Program	86
5.1.2	"Select Points" Measuring Program	88
5.1.3	"Bounding Box Alignment" Measuring Program	90
5.1.4	"Plane Alignment" Measuring Program	92
5.1.5	"Point Alignment" Measuring Program	94
5.1.6	"Plane Line Point Alignment" Measuring Program	96
5.1.7	"Contour Alignment" Measuring Program	98
5.1.8	"Resample" Measuring Program	101
5.1.9	"Trend Removal" Measuring Program	103
5.1.10	"Average Filter" Measuring Program	105
5.1.11	"Median Filter" Measuring Program	107
5.1.12	"Low Pass Filter" Measuring Program	109
5.1.13	"High Pass Filter" Measuring Program	111
5.1.14	"Closing" Measuring Program	113
5.1.15	"Erosion" Measuring Program	115
5.1.16	"Opening" Measuring Program	117
5.1.17	"Remove points" Measuring Program	119
5.1.18	"Wave Compensation" Measuring Program	121
5.1.19	"Profile Section" Measuring Program	123
5.1.20	"Position Correction 2D" Measuring Program	125
5.1.21	"Select Points 2D" Measuring Program	127
5.1.22	"Line Alignment 2D" Measuring Program	129
5.1.23	"Point Alignment 2D" Measuring Program	131
5.1.24	"Average Filter 2D" Measuring Program	133
5.1.25	"Median Filter 2D" Measuring Program	135
6.	Description of the "Evaluation" View	137
6.1	Description of the Measuring Programs in the "Find Objects" Group	139
6.1.1	"Center of Gravity" Measuring Program	140
6.1.2	"Extreme Point" Measuring Program	142
6.1.3	"Plane Fit" Measuring Program	144
6.1.4	"Sphere Fit" Measuring Program	146
6.1.5	"Cylinder Fit" Measuring Program	148
6.1.6	"Cone Fit" Measuring Program	150
6.1.7	"Circular Hole" Measuring Program	152

6.1.8	"Circular Pad" Measuring Program	155
6.1.9	"Rectangular Hole" Measuring Program	158
6.1.10	"Rectangular Pad" Measuring Program	161
6.1.11	"Edge" Measuring Program	164
6.1.12	"Seam" Measuring Program.....	167
6.1.13	"Groove" Measuring Program	169
6.1.14	"QR Code" Measuring Program	171
6.1.15	"Center of Gravity 2D" Measuring Program	173
6.1.16	"Extreme Point 2D" Measuring Program	175
6.1.17	"Line Fit 2D" Measuring Program.....	177
6.1.18	"Circle Fit 2D" Measuring Program	180
6.1.19	"Corner Radius 2D" Measuring Program	183
6.1.20	"Roundness 2D" Measuring Program	186
6.1.21	"Seam 2D" Measuring Program	188
6.1.22	"Groove 2D" Measuring Program.....	191
6.1.23	"Circle Seam 2D" Measuring Program.....	194
6.1.24	"Circle Groove 2D" Measuring Program	197
6.1.25	"Gap 2D" Measuring Program.....	200
6.2	Description of the Measuring Programs in the "Combine Objects" Group	203
6.2.1	"Distance" Measuring Program	204
6.2.2	"Angle" Measuring Program.....	206
6.2.3	"Object Intersection" Measuring Program	208
6.2.4	"Perpendicular Point" Measuring Program	210
6.2.5	"Midpoint" Measuring Program	212
6.2.6	"Line Creation" Measuring Program.....	214
6.2.7	"Plane Creation" Measuring Program	216
6.2.8	"Distance 2D" Measuring Program	218
6.2.9	"Angle 2D" Measuring Program	220
6.2.10	"Object Intersection 2D" Measuring Program	222
6.2.11	"Midpoint 2D" Measuring Program	224
7.	Description of the "Outputs and Results" View	226
7.1	Configuration of the Filters for Measured Values	228
7.2	Calculating Measured Values	229
7.3	Assessing Measured Values (OK/nOK)	230
7.4	Outputting and Logging Measured Values, Controlling the Measurement.....	231
7.4.1	Load parameters in an Automated Manner	234
8.	Appendix.....	235
8.1	Status and Error Messages	235
8.2	Notes and Tips on Using 3DInspect.....	241
8.3	Key Shortcuts / Mouse Functions.....	242
8.4	Color Palettes.....	243

1. Introduction

This user manual gives an overview of the functions of the "Micro-Epsilon 3DInspect" software, referred to in short as 3DInspect in the following. This provides you with the possibility to configure and parameterize the surfaceCONTROL 3D, reflectCONTROL RCS and scanCONTROL 30XX sensors and the „ProfileUnit“ measurement system for your measurement task in order to examine and solve typical 3D measurement tasks with it. The sensors are designed for applications in the industrial environment.

The surfaceCONTROL 3D sensor is used for non-contact optical measurement of diffusely reflective surfaces.

The reflectCONTROL RCS sensor is used for non-contact optical measurement of reflective surfaces.

The scanCONTROL 30XX measurement system is a laser line sensor which is designed for applications in the industrial environment.

With the „ProfileUnit“ measurement system, the 2D profile data from several scanCONTROL 30XX sensors can be combined into a 2D profile for further evaluation.

This product is characterized by high speed and accuracy of measurement. 3DInspect provides you with ways to solve different applications combined with maximum precision.

Note: In the following the term "sensor" stands for the supported sensors.

Note: 3DInspect supports scanCONTROL 30XX sensors with firmware version 52 and above.

1.1 Using this Manual

The user manual contains general information on the installation and use of 3DInspect and on the use of the supported sensors. As a user of the software it is important that you read Chapter 2 "[Installation and Preparation for Measurement Operation](#)". Chapter 3 "[Working with 3DInspect](#)" and Chapter 4 "[Description of the "Data Acquisition" View](#)" explain how to use the basic functions offered by the software. In Chapter 5 "Description of the "Data Preprocessing" View" and Chapter 6 "[Description of the "Evaluation" View](#)" the functions of the individual measuring programs are described. In Chapter 7 "[Description of the "Outputs and Results" View](#)" you will find a description about combining, evaluating, logging and outputting measured values via Ethernet.

Note: Please refer to the contact address printed on the inside cover for any issues relating to queries and support or any other technical information.

1.2 Overview of the Complete System

3DInspect transmits measurement data from the sensors used via Ethernet in a simple way and provides said data in three-dimensional form. These 3D data are further processed, evaluated and assessed in measuring programs with 3DInspect on the PC and, if necessary, logged and transmitted via Ethernet to a control unit. If required, these 3D data can be saved with the software.

The measuring programs can be selected and configured in the software. The programs are arranged in a list and executed from "top" to "bottom". The measuring programs can access results of previous measuring programs, but not the other way round ("waterfall model").

Once parameterization is complete, measurement operation can be activated in the software. The measured values can be output via Ethernet using various protocols (see table below).

You can run 3DInspect in its standard version or with the "Automation" function extension. If you are using the surfaceCONTROL 3D 3X10-XX sensor, this automatically serves as the license for activating the "Automation" function extension. For other sensor types the "Automation" function extension for a certain sensor can be activated with a license file. Please refer to the contact address printed on the inside cover for further information.

To use a scanCONTROL 30XX sensor, you need a network license for 3DInspect. Please refer to the contact address printed on the inside cover for further information. If no network license is present, the error message (see Chapter 8.1) "No network license" is shown in the status bar. In this case you can use the functions of the software and the sensor for 15 minutes. After that the transmitted sensor data is invalid.

Function	3DInspect	3DInspect Automation
Data transmission sensor (online operation)	X	X
Load a stored point cloud (offline operation)	X	X
Sensor parameterization	X	X
"Data preprocessing" measuring programs	X	X
"Find objects" measuring programs	X	X
"Combine objects" measuring programs	X	X
Visualization of point clouds	X	X
Visualization of measurement results	X	X
Combine measured values	X	X
Evaluate measured values	X	X
Restore factory settings	X	X
Offline logging of measurement results	X	X
Load and save parameters	X	X
Select language	X	X
Select unit (mm, μm)	X	X
Synchronization (Hardware trigger)		X*
Synchronization (measurement control via Modbus TCP, EtherNet/IP, Profinet, EtherCAT)		X**
Online logging of measurement results		X
Output of the measured values via Ethernet (UDP, TCP, Modbus TCP, EtherNet/IP, Profinet, EtherCAT)		X**

* The functionality is only available when using a surfaceCONTROL sensor.

** A special hardware extension is necessary for using the EtherNet/IP, Profinet or EtherCAT protocol. Please refer to the contact address printed on the inside cover.

Fig. 1.1: Functional scope of 3DInspect

1.3 Definition of Basic Terms

- **Point cloud:** A surface measured by the sensor is represented by a number of three-dimensional points. Each of these points is defined by its X, Y and Z coordinate.
- **X coordinate:** The transverse coordinate of a three-dimensional point.
- **Y coordinate:** The longitudinal coordinate of a three-dimensional point.
- **Z coordinate:** The vertical coordinate of a three-dimensional point.
- **2D profile:** A two-dimensional profile, which is extracted from a point cloud. Every point from a profile is defined by its U and V coordinate.
- **2D profile sequence:** A chronologically consecutive series of 2D profiles is called a 2D profile sequence.
- **U coordinate:** The horizontal coordinate of a two-dimensional point.
- **V coordinate:** The vertical coordinate of a two-dimensional point.
- **Measuring operation:** Refers to the operation in which a point cloud is detected by the sensor, transmitted and all measured values are determined in the PC.

1.4 Operating Modes

3DInspect offers two operating modes:

- **Setup mode:** The user can set up the sensor and the software for the measuring task at hand and carry out measuring operations if required.
- **Measurement mode:** In measurement mode, measurements can be controlled automatically.

Note: The measurement mode is only available with an activated "Automation" function extension.

For the transfer and evaluation of measurement data two evaluation modes are available:

- **3D:** The sensor transfers three-dimensional point clouds. For evaluation of measurement data measuring programs for processing three-dimensional point clouds as well as for processing 2D profiles ("Profile section from a 3D point cloud") are available. Discrete measuring operations are triggered for transferring and evaluating measurement data.
- **2D:** The sensor transfers two-dimensional profiles. For evaluation of measurement data measuring programs for processing 2D profiles are available. The profiles are transferred and evaluated continuously.

Note: The "2D" evaluation mode is only available when using a scanCONTROL 30XX sensor (see Chapter 3.4.4, "Data format" parameter).

Note: In offline mode the evaluation mode can be freely selected (see Chapter 3.25, section 4).

1.5 Functions of the Measuring Programs

This list of functions should only be used as a brief overview. The measuring programs are split into three groups. A detail description of all measuring programs can be found in Chapter 5.1, 0 and 6.2.

- **Data preprocessing:** Programs for selection, filtering, position correction and alignment of point clouds can be found in this group.
 - Position Correction: Adjusting the mounting position of the sensor using a static rotation and translation.
 - Select Points: Select 3D points by using regions of interest and discard the remaining points.
 - Bounding Box Alignment: Align a point cloud by means of a bounding box.
 - Plane Alignment: Align a point cloud by means of a plane.
 - Point Alignment: Align a point cloud by means of a point.
 - Plane Line Point Alignment: Align a point cloud by means of a plane, a line and a point.
 - Contour Alignment: Align a point cloud by means of a contour.
 - Resample: Resamples the point cloud and creates a point cloud which has a grid with defined point distances in x and y direction.
 - Trend Removal: Remove a trend of a point cloud.
 - Average Filter: Filter a point cloud by using an average filter.
 - Median Filter: Filter a point cloud by using a median filter.
 - Low Pass Filter: Filter a point cloud by using a low pass filter.

- High Pass Filter: Compute the difference of a point cloud which has been filtered with a low pass filter from the original point cloud.
 - Closing: Fill gaps of a point cloud by using a dilatation and an erosion filter.
 - Erosion: Filter a point cloud by using an erosion filter.
 - Opening: Enlarge gaps of a point cloud by using a dilatation and an erosion filter.
 - Remove Points: Remove isolated points.
 - Wave compensation: Compensate waves in y direction.
 - Profile Section: Generate a 2D profile from a point cloud.
 - Position Correction 2D: Adjusting the mounting position of the sensor using a static rotation and translation in the two dimensional space.
 - Select Points 2D: Select 2D points by using regions of interest and discard the remaining points.
 - Line Alignment 2D: Align a 2D profile by means of a line.
 - Point Alignment 2D: Align a 2D profile by means of a point.
 - Average Filter 2D: Filter a 2D profile by using an average filter.
 - Median Filter 2D: Filter a 2D profile by using a median filter.
- **Find objects:** Programs for fitting geometric objects can be found in this group.
- Center of Gravity: Calculate the center of gravity of 3D points.
 - Extreme Point: Calculate an extreme point of 3D points.
 - Plane Fit: Calculate a fitting plane through 3D points.
 - Sphere Fit: Calculate a fitting sphere through 3D points.
 - Cylinder Fit: Calculate a fitting cylinder through 3D points.
 - Cone Fit: Calculate a fitting cone through 3D points.
 - Circular Hole: Measure a circular hole in a point cloud.
 - Circular Pad: Measure a circular pad in a point cloud.
 - Rectangular Hole: Measure a rectangular hole in a point cloud.
 - Rectangular Pad: Measure a rectangular pad in a point cloud.
 - Edge: Measure a straight edge in a point cloud.
 - Seam: Measure a seam in a point cloud.
 - Groove: Measure a groove in a point cloud.
 - QR Code: Reads a QR Code from a point cloud.
 - Center of Gravity 2D: Calculate the center of gravity of 2D points.
 - Extreme Point 2D: Calculate an extreme point of 2D points.
 - Line Fit 2D: Calculate a fitting line through 2D points.
 - Circle Fit 2D: Calculate a fitting circle through 2D points.
 - Corner Radius 2D: Calculate the radius of a 2D corner.
 - Roundness 2D: calculate the roundness of a 2D object.
 - Seam 2D: Measure a seam in a 2D profile.
 - Groove 2D: Measure a groove in a 2D profile.
 - Circle Seam 2D: Measure a seam in a circular 2D profile.
 - Circle Groove 2D: Measure a groove in a circular 2D profile.
 - Gap 2D: Measure a gap in a 2D profile.
- **Combine Objects:** Programs for combing previously found objects.
- Distance: Calculate the distance between two objects.
 - Angle: Calculate the angle difference between two objects.
 - Object Intersection: Calculate a new geometric object by intersection of two objects.
 - Perpendicular Point: Calculate a point by an orthogonal projection from a point to a plane or a line.
 - Midpoint: Calculate the midpoint from two points.
 - Line Creation: Create a straight line from two points.
 - Plane Creation: Create a plane from three points.
 - Distance 2D: Calculate the distance between two 2D objects.
 - Angle 2D: Calculate the angle difference between two 2D straight lines.
 - Object Intersection 2D: Calculate one or two 2D points by intersection of two 2D objects.
 - Midpoint 2D: Calculate the midpoint from two 2D points.

2. Installation and Preparation for Measurement Operation

2.1 Installation Requirements

The following minimum system specification is necessary for the operation of 3DInspect:

- Windows 8 or 8.1 (64 bit), Windows 10 (64 bit)
- 1 GHz or faster (64 bit) processor
- 4 GB RAM
- Screen resolution: 1280 x 1024
- Graphics card / GPU supporting OpenGL 3.1 or higher

The following system specification is recommended:

- Windows 10 (64 bit)
- 3-GHz or faster (64 bit) processor
- 16 GB RAM
- Screen resolution: 1920x1080
- Dedicated graphics card

To be able to use 3DInspect the following steps must be followed:

- ➡ 1. Install the Ethernet interface hardware, if not already installed.
- ➡ 2. Adopt the following settings of the Ethernet interface:
 Jumbo-Frames: Enabled / Use the maximum value
 Interrupt Moderation: Enabled
 Interrupt Moderation Rate: Adaptive
 Receive Buffers: Use the maximum value
- ➡ 3. Install 3DInspect (see Chapter 2.2).
- ➡ 4. Connect the sensor to the PC via Ethernet.

Note: It is recommended to use the PRO 1000 line of Intel PCI Express (PCIe) NICs. You can find further information on using the Ethernet interface hardware on: https://supportcenter.pleora.com/s/article/Configuring-Your-Computer-and-Network-Adapters-for-Best-Performance-KBase#Selecting_a_NIC_and_Laptop

[CD]:\Documentation	Contains manuals and the installation instructions.
[CD]:\Examples	Contains examples of point clouds
[CD]:\License	Contains license information for 3DInspect
[CD]:\Program\3DInspect 1.6	Contains 3DInspect 1.6
[CD]:\Support\eBus	Contains the driver for integrating sensors via GigE Vision.
[CD]:\Support\VCRedist2017	Contains the "Microsoft Visual C++ 2017" Redistributable Package

Fig. 2.1: Content of the Software CD

2.2 Installation of the Software

After extracting the installation files to a temporary folder, an installation window appears which offers you a number of options. Alternatively you can start the window with the [Temporary folder]:\setup.exe file.

- ➡ Click on the "Install" button to start installing the software.

Now the installation wizard installs the software and necessary components.

Note: You need administrator rights in order to install the software.

Note: Activate the "Configure windows firewall" option in order to enable control of the sensor and the data transfer via Modbus TCP in case of an active windows firewall.

Note: If a third-party firewall is installed on your operating system, you need to include 3DInspect in the firewall exception list to enable control of the sensor and the data transfer via Modbus TCP.

2.3 Connecting the Sensor to the PC

In order to connect the sensor via Ethernet to the PC, proceed as follows:

- ➡ Finish the installation of 3DInspect completely. This procedure is described in Chapter [2.2](#).
- ➡ Connect the sensor via the Ethernet interface to the PC and switch on the power supply.
- ➡ Please wait until the sensor is recognized by the PC. This process may take up to one minute.

The system is now ready to operate the sensor with 3DInspect.

Note: The sensor must be connected directly with the PC. Do not use hubs or switches.

Note: The PC and the sensor must be located in the same subnet in order to operate the sensor with 3D-View. Use the "Ethernet configurator" dialog box (see Chapter [3.26](#)) in order to adjust the network settings of the sensor, if necessary.

Note: Use the recommended settings for the Ethernet interface (See Chapter [2.1](#), section 2).

3. Working with 3DInspect

3.1 Launching 3DInspect

- ➡ Once the software and drivers have been installed, launch the software. To do this, use the program shortcut on your desktop or select "3DInspect" in the Start menu.

After the program has started, the software will automatically connect to the sensor connected to the PC. If multiple sensors are connected to the PC, a dialog for selecting the sensor will appear (see Fig. 3.3).

Note: Never change the settings of the Ethernet interface used when the software is running. This may cause the operating system to shut down unintentionally.

Note:

- Never disconnect the connection between the sensor and the PC while using the software.
- Never disconnect the power supply of the sensor while the software is running.

This may cause the software to shut down unintentionally.

3.2 Overview Description

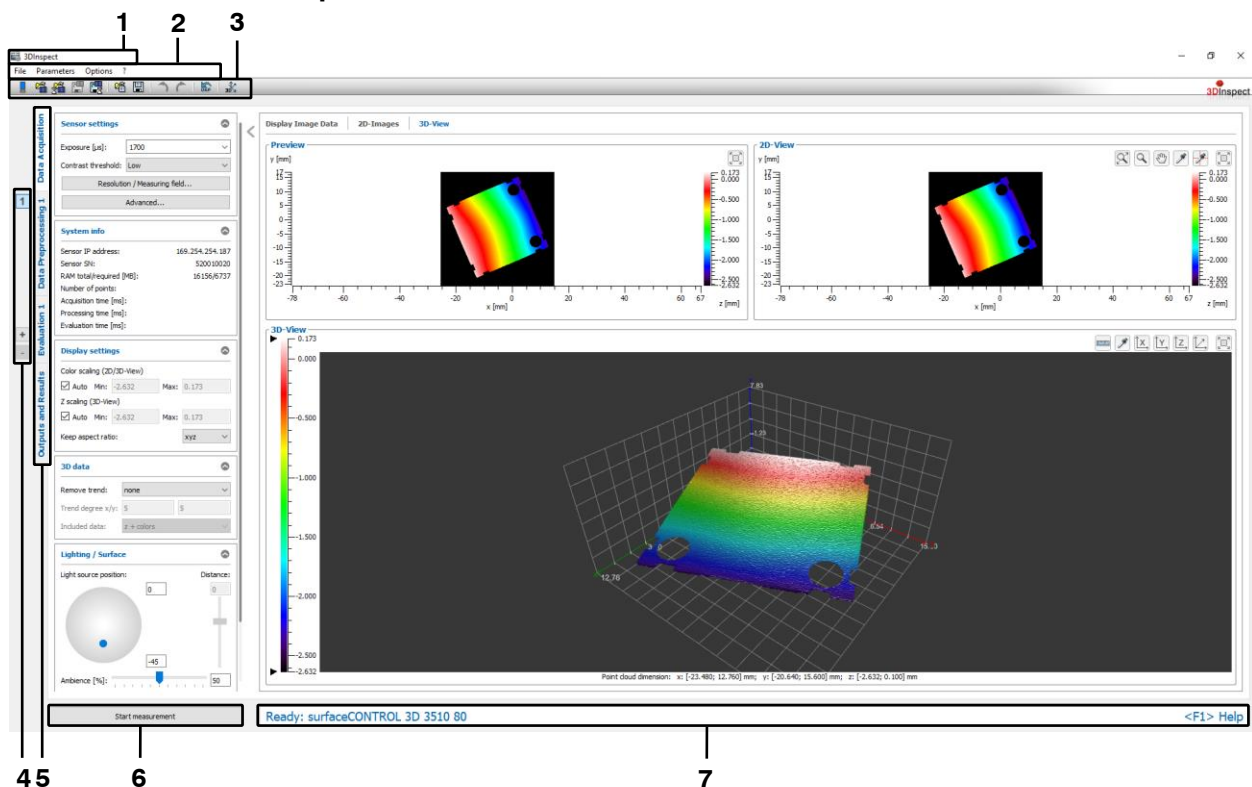

Fig. 3.1: Overview

The figure provides an overview of the software.

1 Title bar: The title bar shows the name of the currently loaded parameter set. If parameters are changed, a * will be added to the name.

2 Menu bar: The menu bar allows you to select the data source, save and export point clouds, save and load parameters, reset selected parameters to the default setting, call up the help screen, set the parameters for the 3D-View and specify basic settings (see Chapter 3.23).

3 "General" toolbar: This toolbar allows you to select the data source, save point clouds, save and load parameters, reset selected parameters to the default setting, undo and restore changes of settings and parameters (see Chapter 3.24) and set the parameters for the 3D-View.

4 Measuring program groups: You may add and remove measuring program groups and select existing program groups in this section (see Chapter 3.17).

5 Tab bar for switching between views: This tab bar allows you to switch between the four main views:

- **Data acquisition:** In this view, you can set the parameters for the sensor for optimal measurement data acquisition (see Chapter 4).
- **Data preprocessing:** In this view, you can select and parameterize programs for preprocessing the measurement data (see Chapter 5).
- **Evaluation:** In this view, you can select and parameterize programs for calculating and combining geometric objects (see Chapter 6).
- **Outputs and results:** In this view, you can filter and calculate measured values, assess them and configure them for output and logging (see Chapter 7). Additionally, you can set the parameters for the software operating mode (see Chapter 1.4).

6 "Start measurement" button: Click on this button to perform a measuring operation, calculate the measured values and display the measured point cloud and the measured values.

7 Status bar: The status bar is shown in the bottom region of the overview. It shows status and error messages. If an error is caused by a measuring program, you can directly access the affected measuring program by clicking on the underlined program name in the status bar. You can find a complete list of all possible messages in Chapter 8.1.

3.3 Steps for Setting the Parameters for a Measuring Task

The following sets out the basic approach for setting the parameters for a measuring task:

- Set the parameters for the sensor in order to ensure optimal measurement data acquisition in the "Data acquisition" view (see Chapter 4).
- In the "Data preprocessing" view, select programs for preprocessing the measurement data (see Chapter 4.5) and set the parameters for the individual programs.
- In the "Evaluation" view, select programs for calculating geometric objects ("Find objects" group, see Chapter 6.1) and set the parameters for the individual programs.
- In the "Evaluation" view, select programs for combining geometric objects (see Chapter 6.2) and set the parameters for the individual programs.
- If applicable, you can configure filters for measured values in the "Outputs and results" view ("Filter" tab, see Chapter 7.1).
- If applicable, you can calculate the results from measuring programs in the "Outputs and results" view ("Calculation" tab, see Chapter 7.2).
- In the "Outputs and results" view, define limit values for selected measured values in order to evaluate the measurement ("OK/nOK" tab, see Chapter 7.3)
- In the "Outputs and results" view, configure the way in which the measurement is controlled and measured values are output ("Input/Output" tab, see Chapter 7.4)
- Once parameterization is complete, save the parameters in a file (see Chapter 3.20.1). You can reload the saved file at a later time.
- In the "Outputs and results" view, select the "Measurement mode" operating mode (see Chapter 7). The software and sensor are now ready to automatically carry out measurements and output measurement results.

3.4 Online Mode

After starting the software 3DInspect is in online mode. In online mode data from the sensor is transferred directly to the PC and visualized by the software.

- ➡ If you are in offline mode, you can activate the online mode either by selecting the "File → Connect to sensor" menu item or by pressing the corresponding button in the toolbar (see Fig. 3.2).



Fig. 3.2: "Connect to sensor" button

If exactly one sensor is connected to the PC, 3DInspect connects to the connected sensor.

If several sensors are connected, a dialog for selecting the sensor appears (see Fig. 3.3). Select a sensor and confirm the dialog with the "OK" button to establish a connection to the selected sensor.

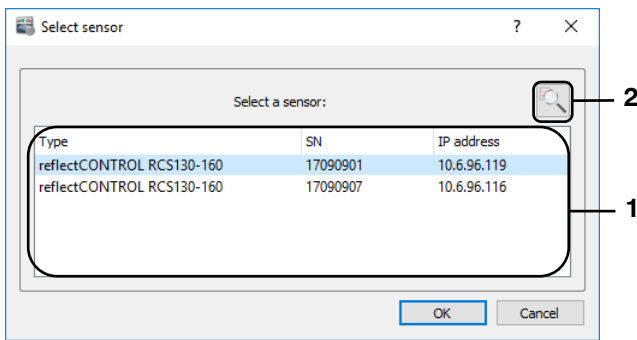

Fig. 3.3: "Select sensor" dialog box

Parameters in the "Select sensor" dialog box:

1 Sensor list: This list contains all Micro-Epsilon 3D sensors which are connected to the PC via Ethernet.

2 Scan for sensors: Press this button in order to identify all sensors which are connected to the PC.

➡ Select a sensor and confirm the dialog with "OK".

3DInspect now uses the connected sensor as data source. You can make settings for the sensor in the "Sensor settings" input field (see Chapter 3.4.1 and 3.4.3).

3.4.1 Description of the "Sensor Settings" Box (reflectCONTROL)

Use the parameters in this box in order to configure the sensor when using the "reflectCONTROL" sensor type.

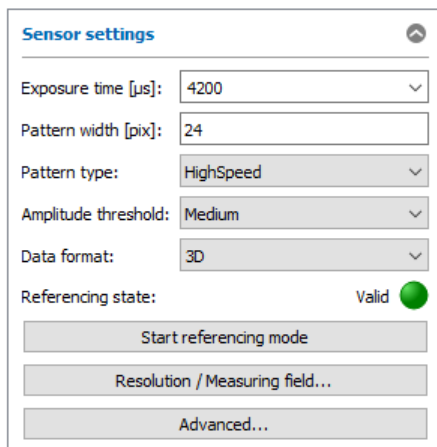

Fig. 3.4: "Sensor settings" box (reflectCONTROL)

You enter the following settings:

- **Exposure time [µs]:** With this parameter you select the exposure time for the scanner.
- **Auto:** In the "Display Image Data" View (see Chapter 4.1.1), an "Auto" button is available. Press this button in order to optimize the exposure time. In doing so, the software evaluates the image regions which are used for computing the histogram (see Chapter 4.1.1). Depending on the initial value it may be necessary to use the button multiple times in order to determine an optimum exposure time.
- **Pattern width [pix]:** This parameter defines the stripe width of the sine pattern on the monitor.
- **Pattern type:** This parameter provides predefined settings options for the number of sine patterns and of the images to be acquired for processing a measurement operation:
 - **HighSpeed:** 4
 - **Balanced:** 6
 - **HighPrecision:** 12
 - **Custom:** Select a custom value for the number of sine patterns (see Chapter 3.4.7, "PatternCount" parameter).
- **Amplitude threshold:** This parameter provides predefined settings options for the amplitude threshold. For the calculation of the results, only pixels with an amplitude value larger than this value are used. Thus, undesirable pixels with low reflectivity (e.g. outside of the measuring object, or on the border) can be excluded.

- **Very low:** 1
- **Low:** 5
- **Medium:** 15
- **High:** 30
- **Custom:** Select a custom value (see Chapter 3.4.7, "AmplitudeThreshold" parameter).
- **Data format:** Select the format of the data to be transferred:
 - **3D:** reflectCONTROL transfers 3D point clouds.
 - **3D + 2D-Images:** In addition to the 3D point clouds reflectCONTROL transfers 2D-Images (see Chapter 4.1.3)
- **Referencing state:** Shows the referencing state, see Chapter 3.4.2
- **Start referencing mode:** Starts the referencing mode, see Chapter 3.4.2
- **Resolution / Measuring field...:** Opens a dialog for parameterization of the resolution and the measuring field in x-/y- direction, see Chapter 3.4.5
- **Advanced...:** With this button you access the "Advanced Sensor settings" dialog box (see Chapter 3.4.7).

Note: The "Sensor settings" dialog box is available only in online mode!

Note: The "Sensor settings" dialog box is available only in the "Data acquisition" view!

Note: For further information on the configuration of the sensor, please refer to the operating instructions of the sensor used (Menu "? → Documentation", refer to Fig. 3.85).

3.4.2 Make Reference Measurements (reflectCONTROL)

In order to perform high precision measurements with the reflectCONTROL sensor, it is possible to initially make reference measurements using special target objects. By means of the reference measurements it is possible to compensate systematic measurement variations for subsequent measurements as far as possible. Proceed as follows in order to setup the sensor for performing high precision measurements:

- Start the referencing mode
- Position the target object
- Make a reference measurement
- Stop the referencing mode

The individual steps are described in detail below:

- Start the referencing mode:

Use the "Start referencing mode" button (see Fig. 3.4). The "Referencing settings" dialog appears (see Fig. 3.5).

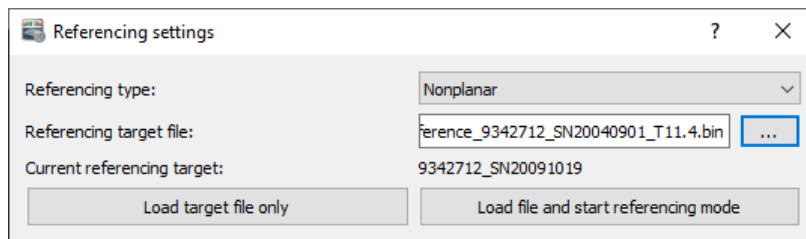

Fig. 3.5: Dialog "Einstellungen Referenzierung"

You enter the following settings:

- **Referencing type:** Two modes are available for referencing. The mode depends on the target object which is used for the reference measurement:
 - **Planar:** An optically flat mirror with negligible flatness deviations is used as target object
 - **Nonplanar:** A mirror with well-known deviations in the μm range is used as target object. When using a nonplanar object, it is necessary to specify a description file of the object (see below).
- **Referencing target file:** When using a nonplanar object, use this field in order to specify the corresponding description file. If you have already specified the file earlier and if you didn't change the referencing object, this step is not necessary. The last loaded file is displayed below ("Current referencing target").

If you only want to load the referencing target file without starting the referencing mode, you may use the "Load target file only" button in order to load the file and close the dialog.

- ➡ Press the "Start referencing mode" or, respectively, the "Load file and start referencing mode" button in order to close the dialog.

The referencing mode is active now. The state "Referencing mode active" is displayed in the "Sensor settings". The "Start referencing mode" button is replaced by the "Stop referencing mode" button. The "Start measurement" button is replaced by the "Start reference measurement" button.

- Position the target object:

- ➡ Open the "Display image data" view (see Chapter 4.1.1).

In case of using a planar referencing target you have to position the target so that it is completely inside the camera images.

The nonplanar target has to be positioned correctly with respect to the sensor. For this, you activate the "Show measuring field" option. With this, a contour is displayed in the camera images. You have to position the target so that it is aligned properly to the desired contour (see Fig. 3.7).



Fig. 3.6: Positioning the reference target – position has to be corrected

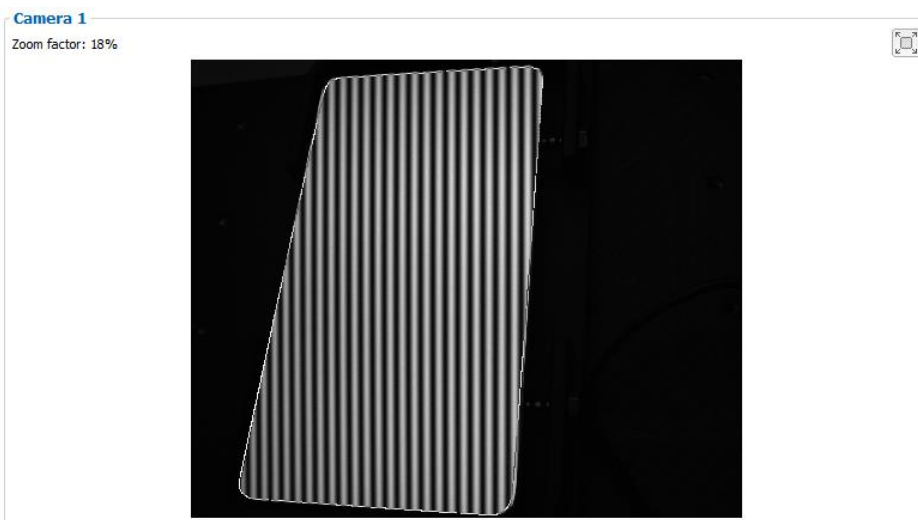

Fig. 3.7: Positioning the reference target – position is OK

- Make a reference measurement:

You may make reference measurements after you have correctly positioned the reference target. To do so, you have to open the 3D-View and to press the "Start reference measurement" button. The sensor executes a reference measurement. Use the preview in order to check the correct distance from the sensor to the reference target:

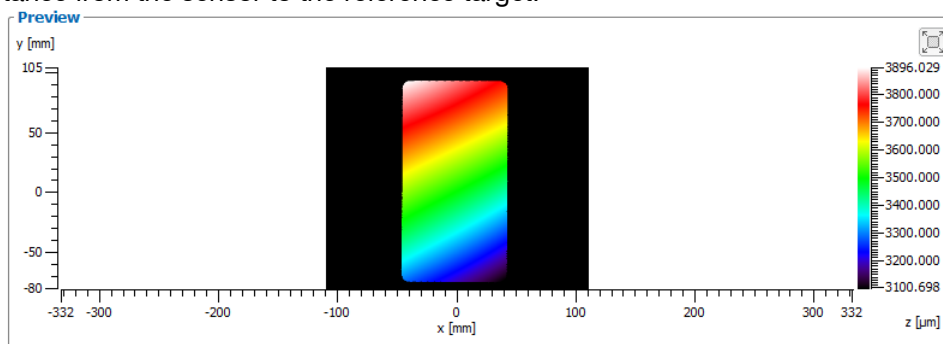

Fig. 3.8: Positioning the reference object – Distance too small

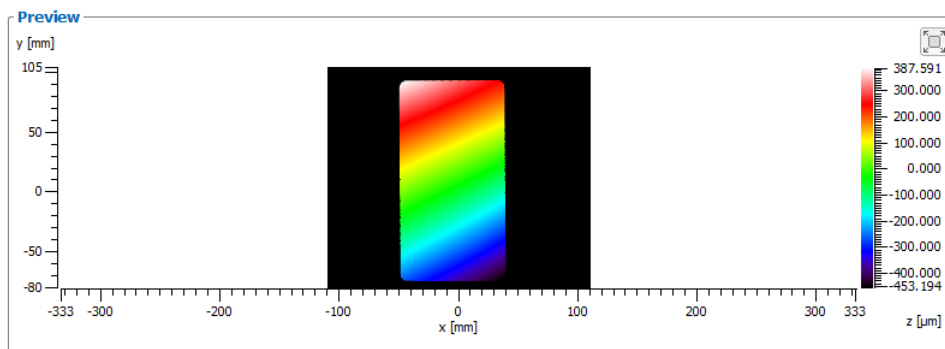

Fig. 3.9: Positioning the reference object – Distance is OK

The scale shows the distance of the reference target surface to the sensors zero level. Please check that the minimum/maximum values don't exceed ± 1 mm. Adopt the distance between reference target and sensor if necessary and repeat the reference measurement. When you have finished you have to check if the latest reference measurement has been executed successfully. For doing this, use the status display in the "Sensor settings" box. When the reference measurement was successful, the status "Referencing mode active: Valid" is displayed and you may leave the referencing mode. In case of an unsuccessful reference measurement the status "Referencing active: Not valid" is displayed. In this case, check the position of the target object and the sensor parameters (Exposure time, etc.), adopt them and repeat the reference measurement.

- Stop the referencing mode:

You may leave the referencing mode after you have successfully executed a reference measurement. Use the "Stop referencing mode" button in order to leave the referencing mode. The following dialog will be displayed:

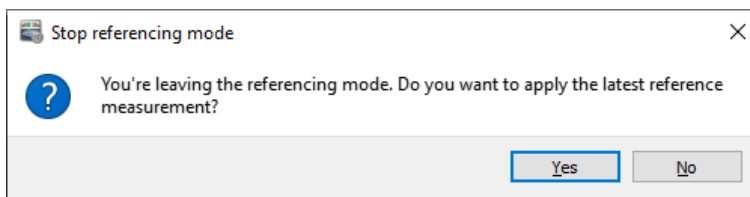

Fig. 3.10: "Stop referencing mode dialog box"

- ➡ Close the dialog using the "Yes" button in order to apply the latest reference measurement and in order to use the referencing.

The sensor is now prepared for performing high precision measurements.

If you close the dialog with "No", you will leave the referencing mode but the referencing won't be activated. The sensor will perform subsequent measurements with standard precision.

- Referencing state display: In the "Sensor settings" box (see Chapter 3.4.1) a state display for the referencing state can be found. The following information may be displayed:
 - Valid (green): The referencing is active and a valid reference measurement is available. The sensor performs high precision measurements.
 - Valid (yellow-green): The referencing mode is active and a valid reference measurement is available. You may leave the referencing mode.
 - Not active (gray): The referencing is not active. The sensor performs measurements with standard precision.
 - Not active (yellow): The referencing is not active, but a valid reference measurement is available. The sensor performs measurements with standard precision.
 - Not valid (yellow): The referencing mode is active but no reference measurement has been made yet or the data of the reference measurement is invalid. Use the "Start reference measurement" button in order to make a reference measurement.
 - Not valid (red): The referencing is active but the data of the reference measurement is invalid. Start the reference mode and make a reference measurement.

- **Binning mismatch (red):** The current value of the binning parameter ("Binning horizontal/vertical") doesn't match with the value used during the reference measurement which is applied. Adopt the binning value or start the reference mode and make a reference measurement.

3.4.3 Description of the "Sensor Settings" Box (surfaceCONTROL)

Use the parameters in this box in order to configure the sensor when using the "surfaceCONTROL" sensor type.

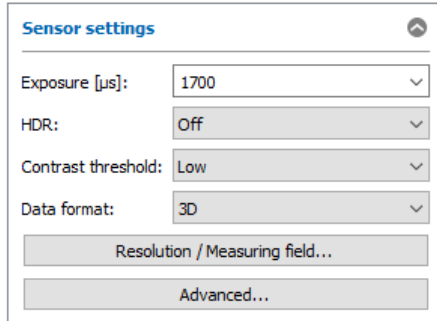

Fig. 3.11: "Sensor settings" box (surfaceCONTROL)

You enter the following settings:

- **Exposure [µs]:** This parameter controls the exposure time of the sensor's cameras per pattern and the brightness of the projection of the fringe patterns. The value is the product of exposure time and brightness. The brightness is 100 % by default and will be only reduced if the minimum exposure time is reached. You may select the "Custom" option in order to set both parameters separately (see Chapter 3.4.7, "ExposureTime" and "LightBrightness" parameters).
- **Auto:** In the "Display Image Data" View (see Chapter 4.1.1), an "Auto" button is available. Press this button in order to optimize the exposure time. In doing so, the software evaluates the image regions which are used for computing the histogram (see Chapter 4.1.1). Depending on the initial value it may be necessary to use the button multiple times in order to determine an optimum exposure time.
- **HDR:** With this parameter you may increase the dynamic range of the raw data which is acquired by the sensor. If this parameter is active, the sensor acquires three images for each fringe pattern whereat different exposure times are used for each image. In the following, the exposure times are referred to B1, B2 and B3. The exposure time which is specified with the "Exposure" parameter corresponds to the medium exposure time B2. The following options are available:
 - **Off:** HDR is not used.
 - **Moderate:** $B1 = B2 / 1.5$; $B3 = B2 * 1.5$;
 - **Normal:** $B1 = B2 / 2$; $B3 = B2 * 2$;
 - **Strong:** $B1 = B2 / 4$; $B3 = B2 * 4$;
 - **Custom:** Use this option in order to specify the factors for the exposure times manually (see Chapter 3.4.7, "MultiSlopeKneePointCount", "MultiSlopeKneePointSelector" and "MultiSlopeExposureLimit" parameters).
- **Current Exposure:** This selection is available in the "Display Image Data" View (see Chapter 4.1.1) and when the HDR parameter is activated. Select the exposure time of the low, medium or high image of the HDR. Use this parameter to check whether the bright areas are not over-illuminated with the low exposure time and the dark areas are sufficiently illuminated with the high exposure time.
- **Contrast threshold:** This parameter provides predefined settings options for the "Graycode threshold" and the "Amplitude threshold" parameters. For the calculation of the results only pixels are used whose gray value difference from bright and dark image is greater than the "Graycode threshold" and whose amplitude value for the received sequence of sine patterns is greater than the "Amplitude threshold". In this way, unwanted pixels with too low gray value difference and with too low reflectance respectively (e.g. outside the measuring object or in the margin range) can be excluded.
 - **Very low:** $AmplitudeThreshold = GraycodeThreshold = 1$
 - **Low:** $AmplitudeThreshold = GraycodeThreshold = 2$
 - **Medium:** $AmplitudeThreshold = GraycodeThreshold = 5$
 - **High:** $AmplitudeThreshold = GraycodeThreshold = 8$

- **Custom:** You may select this option in order to set both parameters separately (see Chapter 3.4.7, "GraycodeThreshold" and "AmplitudeThreshold" parameters).
- **Data format:** Select the format of the data to be transferred:
 - **3D:** surfaceCONTROL transfers 3D point clouds.
 - **3D + 2D-Images:** In addition to the 3D point clouds surfaceCONTROL transfers 2D-Images (see Chapter 4.1.3)
- **Resolution / Measuring field...:** Opens a dialog for parameterization of the resolution and the measuring field in x-/y- direction, see Chapter 3.4.5
- **Pattern projection:** In the "Display Image Data" View (see Chapter 4.1.1) the button "Measuring Field/Resolution" is replaced by the parameter "Pattern projection".
 - **Bright:** With this setting the projector is switched to bright. The maximum measurement field size can be recognized on the part.
 - **Pattern:** By selecting the "pattern" setting a sine pattern is projected onto the part. This setting is used to adjust the optimal exposure time/brightness via the camera images.
 - **Positioning:** This setting is used to adjust the sensor position to the part. A pattern consisting of a cross and several guide lines is projected onto the part. The same pattern is displayed in the camera images. If the component is positioned in the middle of the measuring field (in Z direction) and so at the right distance from the sensor, the crosses in the middle should be exactly on above of the other. The outer guide lines border the measuring field. The other guide lines and circles can be used for the exact alignment of the parts.
- **Advanced...:** With this button you access the "Advanced Sensor settings" dialog box (see Chapter 3.4.7).

Note: The "Sensor settings" dialog box is available only in online mode!

Note: The "Sensor settings" dialog box is available only in the "Data acquisition" view!

Note: For further information on the configuration of the sensor, please refer to the operating instructions of the sensor used (Menu "? → Documentation", refer to Fig. 3.85: "?" menu).

3.4.4 Description of the "Sensor Settings" Box (scanCONTROL 30XX)

Use the parameters in this box in order to configure the sensor when using the "scanCONTROL 30XX" sensor type.

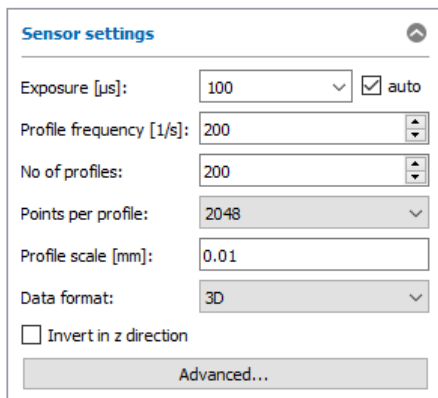

Fig. 3.12: "Sensor settings" box (scanCONTROL 30XX)

You enter the following settings:

- **Exposure [µs]:** With this parameter you select the exposure time for scanCONTROL. This value has priority over the "Profile frequency" parameter.
 - **Minimum value:** 1 µs
 - **Maximum value:** 40959 µs
- **Exposure auto:** Select this option to activate the automatic exposure time control of the scanCONTROL sensor. This setting is recommended for scanning single-colored, alternating surfaces.
- **Profile frequency [1/s]:** This parameter controls the number of profiles which are acquired per second and transferred to the PC.
 - **Minimum value:** 25
 - **Maximum value:** Depends on the type of sensor:

- **scanCONTROL 3000/3010:** 10000
- **scanCONTROL 3002/3012:** 5000
- **No. of profiles:** This parameter defines the number of profiles that make up a point cloud.
- **Points per profile:** This parameter defines the number of points that make up a profile. With this parameter you specify the resolution in the direction of the X axis. The number of points is also influenced by the settings in the "Measuring field" section (see Chapter 4.1.2). Depending on the type of sensor you can choose between the following values:
 - scanCONTROL 30X0:
 - 256
 - 512
 - 1024
 - 2048
 - scanCONTROL 30X2:
 - 256
 - 512
 - 1024
- **Profile scale [mm]:** With this parameter you specify the distance between two consecutive profiles in y direction. If the encoder is deactivated (see Chapter 3.4.7, "EncoderOutputMode" parameter), the profile scale arises from the profile frequency and the feed speed. If the encoder is active, the software uses the profile scale and the encoder resolution in order to compute the encoder divider.
- **Video image resolution:** In the "Display Image Data" tab (see Chapter 4.1.2), you may change the resolution of the sensor matrix image:
 - **full:** The image of the sensor matrix is transmitted in full resolution.
 - **reduced:** The image of the sensor matrix is transmitted in reduced resolution. This setting can be used if the bandwidth of the Ethernet connection is insufficient for the full resolution.

Note: In order to use the full image resolution of scanCONTROL 30X0 a gigabit Ethernet connection is required and the "Jumbo frames" option of the Ethernet interface has to be active.

- **Data format:** Select the format of the data to be transferred and the associated evaluation mode of 3DInspect (see Chapter 1.4):
 - **2D:** surfaceCONTROL transfers 2D profiles.
 - **3D:** surfaceCONTROL transfers 3D point clouds.
- **Invert in z direction:** The data is inverted in z direction.
- **Advanced...:** With this button you access the "Advanced Sensor settings" dialog box (see Chapter 3.4.7).

Note: The "Sensor settings" dialog box is available only in online mode!

Note: The "Sensor settings" dialog box is available only in the "Data acquisition" view!

Note: For further information on the configuration of the sensor, please refer to the operating instructions of the sensor used (Menu "?" → Documentation", refer to Fig. 3.61: "?" menu).

3.4.5 Description of the "Sensor Settings" Box (ProfileUnit)

Use the parameters in this box in order to configure the sensor when using the „ProfileUnit“ measurement system.

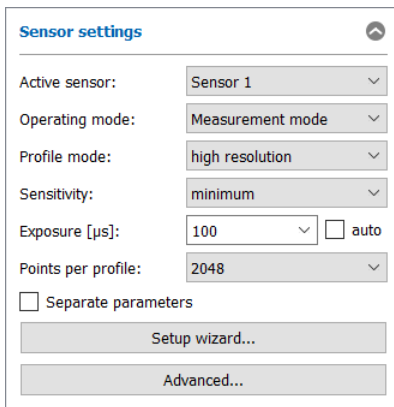

Fig. 3.13: "Sensor settings" box (ProfileUnit)

Note: When setting up the ProfileUnit for the first time, use the setup wizard to ensure basic system functionality.

Note: The elements of the input field vary depending on the selected view.

You enter the following settings:

- **Active sensor:** This selection field can be used to select one of the scanCONTROL sensors which are connected to the „ProfileUnit“ measurement system. The selected sensor can be parameterized with the parameters listed below.
- **Operating mode:** You can use this selection field to set the „ProfileUnit“ measurement system operating mode:
 - **Measurement mode:** The sensors connected to the „ProfileUnit“ measurement system provide the measurement data according to the respective settings, especially triggering. The frequency of the measurement data is controlled by the "Profile frequency" parameter (see below).
 - **Simulation:** The sensors connected to the „ProfileUnit“ measurement system are triggered internally. The frequency of the measurement data is controlled with the "Profile frequency" parameter (see below).
 - **Simulation 25 Hz:** The sensors connected to the „ProfileUnit“ measurement system are triggered internally. The frequency of the measurement data is 25 Hz.
- **Profile mode:** With this parameter you select the operating mode of the selected sensor.
 - **High resolution:** The sensor is operated with the maximum resolution in Z direction.
 - **High speed:** The sensor is operated with the maximum profile frequency. The resolution in Z direction is halved. The resolution in the X direction remains unchanged.
 - **High dynamic range (HDR):** The sensor is operated in the High Dynamic Range (HDR) mode. The resulting profile is composed of two profiles with different exposure times.
- **Sensitivity:** Use this value to define the sensitivity of the selected sensor.
 - **minimum:** The selected sensitivity corresponds to the minimum value.
 - **low:** The selected sensitivity corresponds to the low value.
 - **medium:** The selected sensitivity corresponds to the medium value.
 - **high:** The selected sensitivity corresponds to the high value.
 - **maximum:** The selected sensitivity corresponds to the maximum value.
- **Exposure [µs]:** With this parameter you select the exposure time for the selected sensor.
- **auto:** Select this option to activate the automatic exposure time control of the selected sensor.
- **Points per profile:** This parameter defines the number of points that make up a profile of the selected sensor.
- **Profile frequency [1/s]:** This parameter controls the number of profiles which are acquired per second and transferred. If the sensors connected to the „ProfileUnit“ measurement system are triggered internally by a master, the parameter decisively determines the profile frequency. If the connected sensors are triggered externally (via a digital input), the parameter determines the upper limit of the profile frequency.

- **Separate parameters:** Use this option to determine whether the parameters should apply to the currently selected sensor (option enabled) or to all sensors connected to the „ProfileUnit“ measurement system (option disabled).
- **Setup wizard...:** 3DInspect provides you with a setup wizard to help you get started. The assistant guides you in a few steps to the optimal triggering and synchronization of the sensors.
- **Advanced...:** With this button you access the "Advanced Sensor settings" dialog box (see Chapter [3.4.7](#)).

3.4.6 Description of the "Resolution / Measuring field" Dialog Box

This dialog box allows adjustments to the resolution and measuring field.

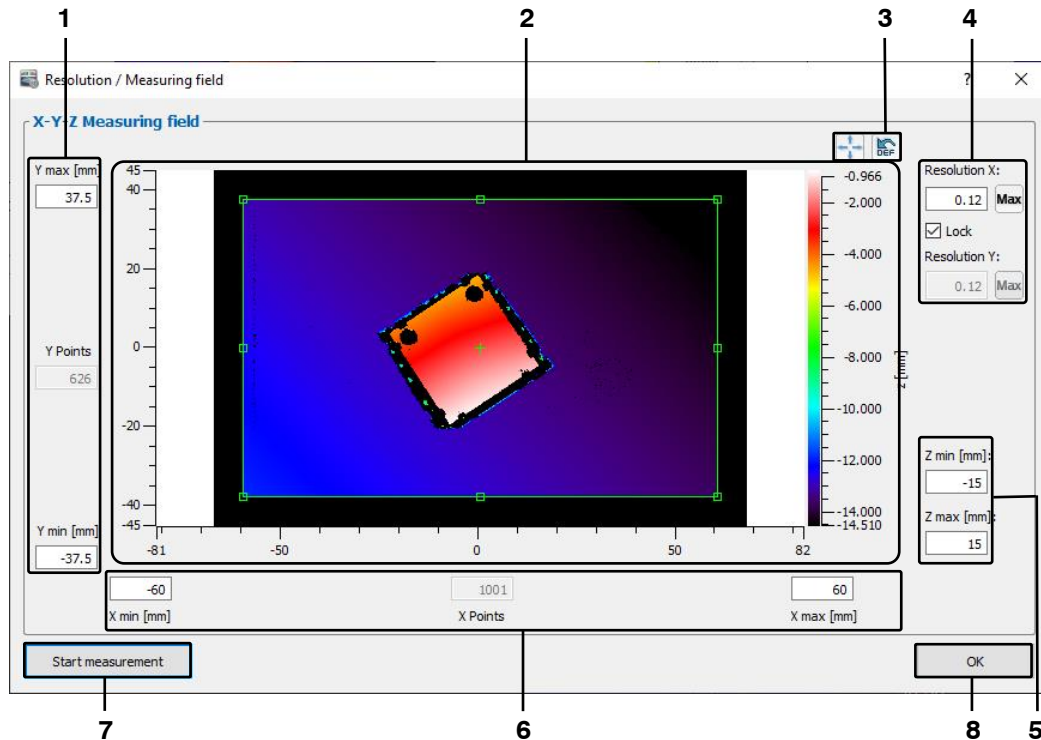

Fig. 3.14: "Resolution / Measuring field" dialog box

The image ② in the center of the dialog box displays the measuring field of the sensor. To change the size of the measuring field you can either enter numerical values in the input fields ①, ⑥ or modify the green rectangle with the mouse pointer. The number of data points is calculated and adjusted automatically. You can use the buttons on the right above the image ③ to maximize the measuring field or to reset all parameters of this dialog to factory default.

To change the resolution ④, enter the desired values for the resolution in X and Y direction in the upper right corner. Use the "Lock" option to enforce an equal resolution in X and Y direction. Click the "Max" buttons to set the highest resolution in the correspondent direction.

Use the input fields in range ⑤ to parameterize the limits for the measuring field in z direction. If the entered values exceed the standard measuring range, a note is displayed that the accuracy of the sensor now is optimized to the entire range in the Z direction, which leads to a reduced accuracy in the standard measuring range.

If limits are violated due to changes, the measuring field is reset to the last valid setting. To check the measuring field, use the "Start measurement" button ⑦. Use the OK button ⑧ to leave the dialog and the entered values will be saved.

Note: The parameters for setting the measuring field in Z direction are only available when using a surfaceCONTROL sensor.

Note: For surfaceCONTROL and reflectCONTROL, negative values are used for scaling in the Y direction as of firmware version 2.

3.4.7 Description of the "Advanced Sensor Settings" Dialog Box

This dialog box offers you extended settings for the sensor used. The parameters which are provided by the sensor via GenICam are available.

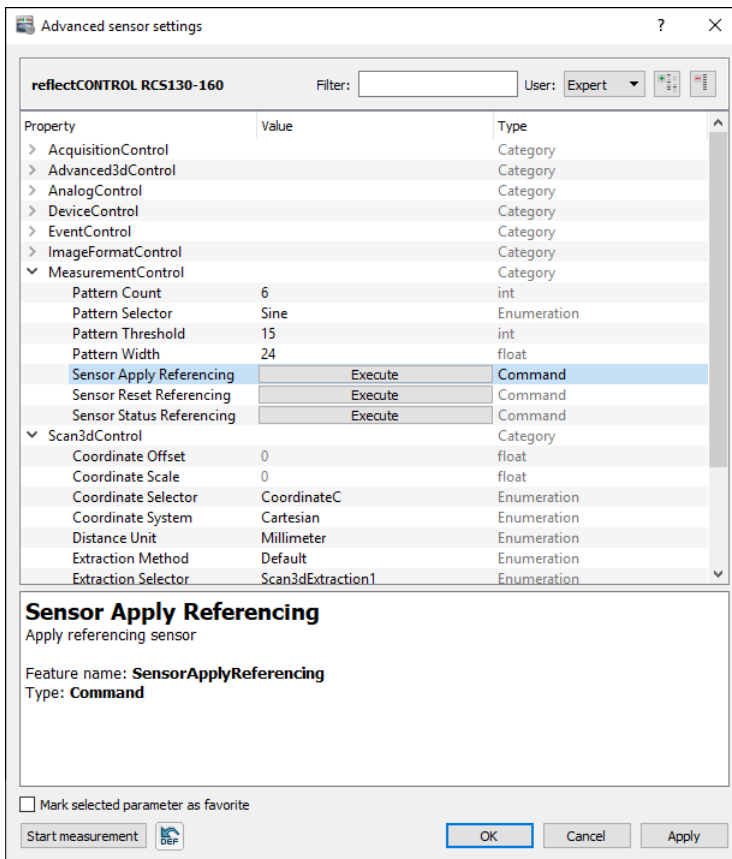

Fig. 3.15: "Advanced Sensor settings" dialog box

You enter the following settings:

- **Filter:** Use this input field in order to seek for specific parameters in the parameter tree. All parameter which do not contain the entered pattern will be hidden.
- **User:** Define the user level. All parameters which have a higher user level will be hidden. To select favorite parameters use the "Mark selected parameter as favorite" check box. The marked parameters are visible in the user level "Favorite". The following user levels are available:
 - **Beginner**
 - **Expert**
 - **Guru**
 - **Favorite**
- **Expand elements:** Use this button in order to expand the complete parameter tree.
- **Collapse elements:** Use this button in order to collapse the complete parameter tree.
- **Parameter tree:** The parameter tree contains all parameters which are provided by the sensor.

Use the "**Start measurement**" button in the lower left corner to start a measurement or press the "**Load sensor default settings**" button to load and apply the default settings of the sensor.

3.4.8 Measurement wizard

3DInspect provides you with a measurement wizard to help you get started. In just a few steps, the wizard guides you to the optimal distance and positioning of the measurement object, helps you make optimal sensor settings, and performs a measurement. The wizard will be started by default when you connect to a sensor (see Chapter 3.25, section 1) and you may start the wizard manually by using the "File → Start measurement wizard" menu entry.

Note: The measurement wizard is only available when using a surfaceCONTROL or a reflectCONTROL sensor.

3.5 Offline Mode

3DInspect enables you to load previously saved point clouds, to compute the corresponding measured values and to visualize the point cloud and the measured values. In offline mode the "Sensor settings" box is replaced by the "File settings" box. Depending on the selected data format (see Chapter 1.4, 3.4.4 and 3.25, section 4) either a 3D point cloud or a 2D profile sequence will be loaded.

- ➡ In order to load and display a point cloud from a file offline, either select the "File → Open 3D file" / "Load profile sequence" menu item or press the corresponding button (see Fig. 3.16) in the toolbar.



Fig. 3.16: "Open 3D file" / "Load profile sequence" button

A standard Windows dialog is displayed where you select the path and file name. The point cloud is loaded after confirmation of the dialog. The loaded point cloud is shown in the preview window, the 2D-View and the 3D-View.

Note: Use the "Recent 3D files" menu item to load and display previously saved or loaded point clouds (see Fig. 3.82).

If the "3D" data format is used (see Chapter 1.4, 3.4.4 and 3.25, section 4), 3DInspect also offers the possibility to load multiple point clouds. Then you may select a certain point cloud in the list of loaded point clouds in order to display it and its corresponding measured values.

- ➡ In order to load multiple point clouds offline, either select the "File → Open 3D files" menu item.

A standard Windows dialog is displayed where you select the desired files. The selected files are displayed in a list (see Fig. 3.19) after confirmation of the dialog and the first point cloud is shown in the preview window, the 2D-View and the 3D-View.

3.5.1 Description of the "File Settings" Box

The available elements of the "File Settings box" vary depending on the data format (see Chapter 3.25, section 4), the number of loaded files and the current view.

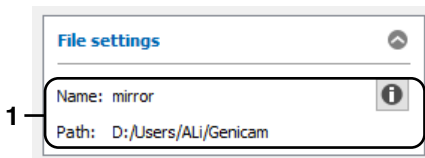

Fig. 3.17: Settings in offline mode – single file ("3D" data format)

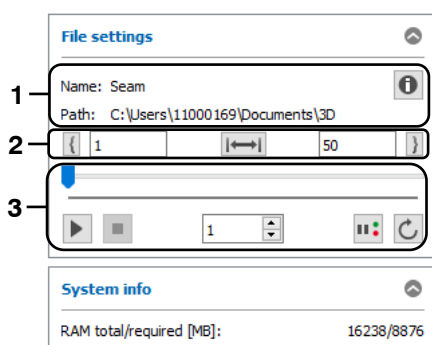







Fig. 3.18: Settings in offline mode – single file ("2D" data format)

Display Elements and Parameters in the "File settings" Box – single file:

- 1
 - **Name:** Name of the loaded file.
 - **Path:** The folder which contains the loaded file.
 - **File info:** Press this button in order to display extended information about the loaded point cloud. From 3DInspect version 1.4 onward the sensor settings will be saved as well. If the selected point cloud is saved with an older version, the sensor settings won't be available.

- 2
 - **Mark profile sequence:** You may mark a partial range of the loaded 2D profile sequence using these input fields. When starting the playback only the marked range is played back.
 -  22: Use this button in order to use the 2D profile currently displayed as lower limit of the marked range. Use the edit field in order to change the lower limit manually.
 - : Resets the marked range. When starting the playback the complete 2D profile sequence is played back.
 - 822 : Use this button in order to use the 2D profile currently displayed as upper limit of the marked range. Use the edit field in order to change the upper limit manually.
- 3
 - **Play/Pause:** This starts/pauses the playback of the selected 2D profile sequence.
 - **Stop:** This stops the playback of the selected 2D profile sequence.
 - **Slider control:** Shows the progress of the playback of the 2D profile sequence. When the playback is stopped you can activate individual profiles by dragging the slider.
 - **Current profile** 374 : While a 2D profile sequence is being played you will see a run-through of the profile numbers in this box. If you stop the playback you can activate any individual profile directly by entering the profile number.
 - **Pause if nOK** : If you activate this option, the playback of the 2D profile sequence is paused if at least one digital output is evaluated as nOK (see Chapter 7.3) in the displayed profile.
 - **Endless mode:** Use this button in order to activate the endless playback mode. After reaching the upper limit of the partial range for playback, the playback restarts automatically at the lower limit of the range.

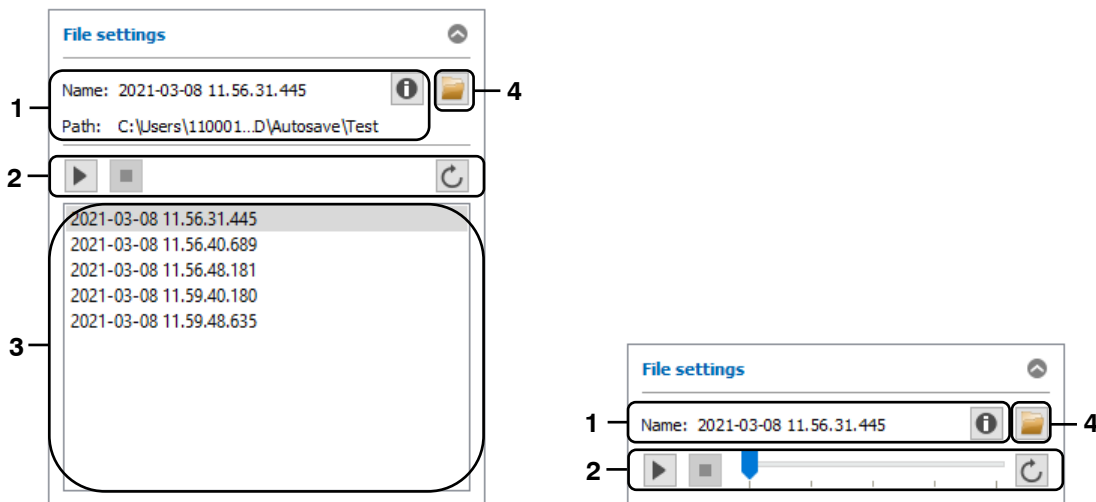

Fig. 3.19: Settings in offline mode – multiple files ("3D" data format)

Display Elements and Parameters in the "File settings" Box – multiple files:

- 1
 - **Name:** Name of the loaded file.
 - **Path:** The folder which contains the loaded file.
 - **File info:** Press this button in order to display extended information about the loaded point cloud. From 3DInspect version 1.4 onward the sensor settings will be saved as well. If the selected point cloud is saved with an older version, the sensor settings won't be available.
- 2
 - **Play/Pause:** This starts/pauses the playback of the loaded point clouds. When the playback is active, the point clouds are processed top down. The currently processed point cloud is visualized and its measured values are displayed.
 - **Stop:** This stops the playback of the point clouds.
 - **Endless mode:** Use this button in order to activate the endless playback mode. After reaching the last point cloud in the list for playback, the playback restarts automatically at the first point cloud.
 - **Slider control:** Shows the progress of the playback. When the playback is stopped you can activate individual point clouds by dragging the slider.
- 3
 - **List of point clouds:** Shows the loaded point clouds. When the playback is stopped you can activate individual point clouds in order to visualize them and display their measured values.

- 4 - **Open explorer:** Opens the Windows Explorer and shows the folder which contains the loaded files.

Note: The "File settings" box is only available in offline mode!

3.6 Saving Point Clouds

3DInspect enables you to save the point cloud transferred from a sensor, the associated 2D measurement data or the camera images to a file. The point cloud file can later be loaded for offline analysis (see Chapter 3.5).

3.6.1 Saving Point Clouds / 2D Measurement Data / Camera Images manually

You may save point clouds, 2D measurement data or camera images manually if required. Depending on the evaluation mode (2D/3D, see Chapter 1.4) it is possible to save the following data:

- "Display Image Data" Tab:
 - Camera images
- "2D-Images" / "2D-View" / "3D-View" Tab:
 - 3D point clouds or 2D profile sequences
 - 2D measurement data
 - 2D-View

➡ In order to save the point cloud or profile sequence transferred from a sensor ("2D-Images" / "2D-View" / "3D-View" Tab), select the "File → Save 3D file" or "File → Save profiles" menu item or press the corresponding button in the toolbar (see Fig. 3.20).



Fig. 3.20: "Save 3D file" (3D data format) / "Save profiles" (2D data format) button

➡ In order to save the camera images transferred from a sensor ("Display Image Data" Tab), select the "File → Save camera images" menu item or press the corresponding button in the toolbar (see Fig. 3.20).



Fig. 3.21: "Save camera images" button

If you are saving a 3D point cloud or a 2D profile sequence, a standard Windows dialog is displayed where you select the path and file name for saving the point cloud / profile sequence. The data transferred from a connected sensor or loaded from a file is saved in the selected file after confirmation of the dialog.

If you are saving camera images, the following dialog is displayed:

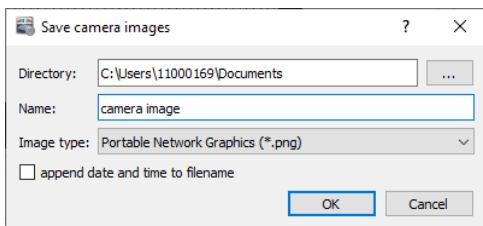

Fig. 3.22: "Save camera images" dialog

You enter the following settings:

- **Directory:** Select the directory in which the images will be stored.
- **Name:** Specify the name (without file extension) which will be used for the files.
- **Image type:** select the image type for the files.
- **Append date and time to filename:** Select whether to append date and time to the filename.

Confirm with OK in order to save the camera images which have been transferred from the sensor at last.

➡ In order to save the point cloud transferred from a sensor and/or the associated 2D measurement data, select the "Save measurement data" menu item.

The following dialog is displayed where you select the path, file and the data to be saved:

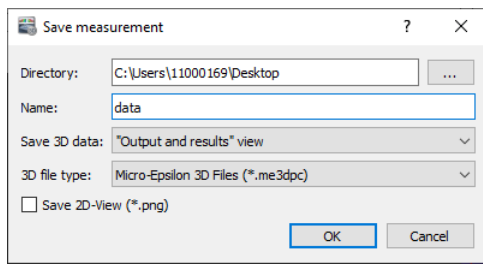

Fig. 3.23: "Save measurement" dialog box

You enter the following settings:

- **Directory:** Select the directory in which the data will be stored.
- **Name:** Specify the name (without file extension) which will be used for the files.
- **Save 3D data:** Select which 3D data should be saved:
 - **None:** No 3D data will be saved:
 - **Sensor:** Select this option in order to save the point cloud which has been transferred from the sensor.
 - **"Outputs and results" view:** Select this option in order to save the point cloud which has been selected in the "Outputs and results" view.
- **3D file type:** Select the type of the file to which the selected point cloud is saved.
- **Save 2D data:** Select this option in order to save the 2D measurement data (amplitude, curvature and base intensity images).
- **Save 2D-View:** Select this option in order to save the 2D-View as color image.

Confirm with OK in order to save the selected data.

3.6.2 Saving Point Clouds automatically

3DInspect offers the possibility to save point clouds after each measuring operation automatically.

- ➡ In order to activate or deactivate the automatic saving of point clouds, select the "File → Auto save 3D files" menu item or press the corresponding button in the toolbar (see Fig. 3.24).



Fig. 3.24: "Auto save 3D files" button

A more detailed description of the available settings for the automatic saving can be found in Chapter 3.25, Section 4.

Note: 3DInspect checks the free space on the target medium when saving point clouds. If the free space is smaller than 500MB, a warning is displayed. If the free space is smaller than 100MB, 3DInspect deactivates the automatic saving.

3.7 Description of the Status Display

The status is displayed in the "Data acquisition" and "Evaluation" views. Depending on the current sub-view (see Chapter 4), the following information is displayed:

System info		System info	
Sensor IP address:	192.168.1.3	Sensor IP address:	192.168.1.2
Sensor SN:	520010020	Sensor SN:	520010004
RAM total/required [MB]:	16238/10867	RAM total/required [MB]:	16238/7329
Number of points:	592.515	Frame rate [1/s]:	10.0
Acquisition time [ms]:	2324		
Processing time [ms]:	1377		
Transmission time [ms]:	57		
Evaluation time [ms]:	69		

Fig. 3.25: "Status display" box (3D-View / Display Image Data)

- **Sensor IP address:** The IP address of the connected sensor.
- **Sensor SN:** The serial number of the connected sensor.
- **RAM total/required [MB]:** Two values are displayed. The first value indicates the size of the physical RAM of your system. The second value indicates the size of the memory currently used. If the value of the memory used exceeds that of the available memory, the system may accept user inputs only very slowly and error-free behavior is no longer guaranteed. In this case the indicated "RAM total/required" is shown in red.
- **Number of points:** The number of points in the point cloud.
- **Acquisition time [ms]:** The required time for the pattern projection and the image acquisition of the last executed measurement.
- **Processing time [ms]:** The required time for the calculation of the 3D data in the sensor of the last executed measurement.
- **Transmission time [ms]:** The required time for the transmission of the data from the sensor to the PC.
- **Evaluation time [ms]:** The required time for the calculation of the measured results of the active measuring programs and for the evaluation and the output of the selected measured values.
- **Frame rate [1/s]:** The frame rate of the camera images in the "Display Image Data" view.

Note: The size of the memory used should always be smaller than the size of the available memory. Otherwise the software may accept user inputs only very slowly and may lead to undesired behavior.

3.8 Description of the "Display Settings" Box

The "Display settings" box is available in the "Data acquisition" and "Outputs and Results" views. The parameters in this box have an effect on the representation in the 2D- and 3D-Views.

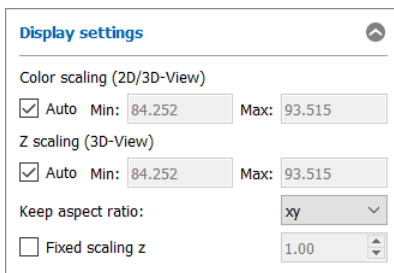

Fig. 3.26: "Display settings" box

You can make the following settings:

- **Color scaling (2D/3D-View):** With these parameters you configure the color scaling in the 2D- and 3D-Views. Your entries in the fields "Min:" and "Max:" are specifications in mm or μm (see Chapter 3.12, "Unit X/Y/Z coordinates" parameter).
 - **Auto:** The scaling adapts to the smallest and largest Z value of the point cloud automatically.
 - **Min/Max:** Use this parameter for manual color scaling.
- **Z scaling (3D-View):** With these parameters you configure the scaling of the Z axis in the 3D-View. Your entries in the fields "Min:" and "Max:" are specifications in mm or μm (see Chapter 3.12, "Unit X/Y/Z coordinates" parameter).
 - **Auto:** The scaling adapts to the smallest and largest Z value of the point cloud automatically.
 - **Min/Max:** You use these parameters for manual scaling of the Z axis.
- **Keep aspect ratio:** With this parameter you determine the type of scaling for the preview, 2D-View and 3D-View.
 - **None:** The scaling adapts itself separately for each axis to the smallest and largest value on the axis.
 - **xyz:** The display is scaled so that the real aspect ratio of the displayed object is retained.
 - **xy:** The display is scaled so that the real aspect ratio of the displayed object is retained in X and Y direction. In Z direction the scaling is influenced by the parameter "Fixed scaling z" (see below).
- **Fixed scaling z:** This option is only available with the "xy" aspect ratio. If this option is not active, the value range in Z direction adapts to the smallest and largest Z value of the point cloud. If this option is active, you use this parameter to determine the factor for scaling the 3D display in the Z direction based on the scaling in X/Y direction.

Note: The color scaling may be adopted additionally by using the sliders which are located next to the color scale in the 3D-View (see Fig. 3.29).

Note: The "Display settings" box is available in both online mode and offline mode!

3.9 Description of the "3D Data" Box

3DInspect allows you to remove a trend of 3D data. The parameters in this box have an effect on the representation in the 2D- and 3D-Views.



Abb. 3.27: "3D data" box

To determine a trend, a polynomial is fitted to the surface which is selected in the 2D-View (see Chapter 4.4.2) using an approximation method. Subsequently, the fitted polynomial is subtracted from the surface. You can make the following settings:

- **Remove trend:** Use this parameter to configure the shape of the trend.
 - **none:** No trend is fitted.
 - **plane:** A trend is fitted in the form of a plane.
 - **custom...:** Specify the degree of the trend polynomial:
 - **Trend degree x:** The degree of the trend polynomial in X direction.
 - **Trend degree y:** The degree of the trend polynomial in Y direction.
- **Included data:** Define which data should be considered for removing the trend:
 - **z + colors:** The fitted trend is subtracted from the 3D coordinates and the color values.
 - **colors:** The fitted trend is only subtracted from the color values.

Note: The "3D data" box is available in both online mode and offline mode!

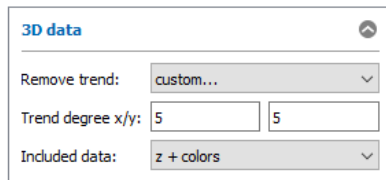
Note: The settings in the "3D data" box have only impact on the displayed point cloud in the "Data acquisition" view. The measuring programs and their corresponding views are not affected by these settings.

3.10 Description of the "Lighting / Surface" Box

The "Lighting/Surface" box is available in the "Data acquisition" and "Outputs and Results" views. Parameterize the properties of the lighting and the surface of the 3D data in this input field. You can optimize the appearance of the 3D data with these settings in order to view details of the surface better, such as small defects. The lighting effects are most effective when selecting the drawing method "triangles" (Parameter "Profiles") and when using a single surface color in the "3D-View settings" dialog (see Chapter 3.12).

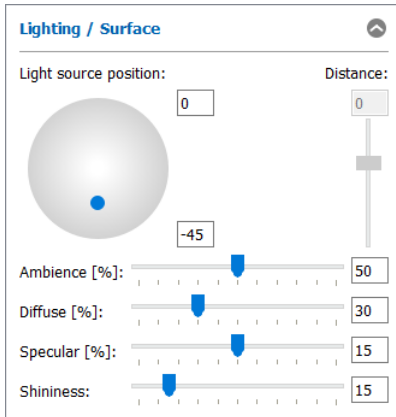

Fig. 3.28: "Lighting/Surface" box

You can make the following settings:

- **Light source position:** Use the blue knob to adjust the position of the light source directly with the mouse. Alternatively, you can use the input fields to set the position in degrees (+ -90°). Use the input field on the right to set the distance of the light source.
- **Ambience [%]** (0 - 100): Change the intensity of the ambient light in the 3D-View.
- **Diffuse [%]** (0 - 100): With this parameter you can change the proportion of the diffuse reflected light from the surface.
- **Specular [%]** (0 - 30): With this parameter you can change the proportion of the direct reflected light from the surface.
- **Shininess** (0 - 100): Change the shininess of the surface in the 3D-View.

Note: The "Lighting/Surface" box is available in both online mode and offline mode!

3.11 Description of the 3D-View

The 3D-View visualizes the last measured point cloud of the sensor and the input point cloud of the current selected measuring program respectively. The colored texture of the display represents the height values of the individual points. On the left side the current color scaling for the 3D-View is displayed. In the lower section the currently visible range is displayed for each axis. The 3D display offers the following interaction options:

- **Rotating the point cloud:** Press the left mouse button and keep the button pressed. Move the mouse to the left or right to rotate the point cloud horizontally. Move the mouse up or down to rotate the point cloud vertically. Press the <Alt> key and the left mouse button in order to activate the alternative rotate algorithm (alternative rotation axes).
- **Zooming in/out the point cloud:** Press the <Ctrl> key and the left mouse button and keep both key and button pressed. Move the mouse upwards to zoom in the point cloud. Move the mouse downwards to zoom out the point cloud. Alternatively, you can use the mouse wheel to zoom in and out.
- **Moving the range:** Press the <Shift> key and the left mouse button and keep both key and button pressed. Move the mouse in the direction in which you like to move the point cloud.

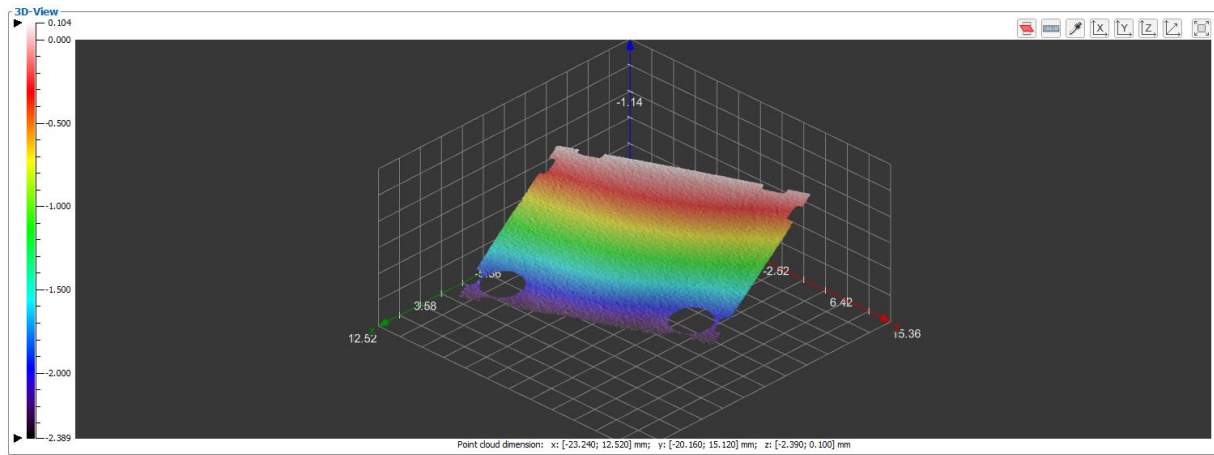

Fig. 3.29: 3D-View

3DInspect offers the possibility to adjust the orientation of the 3D-View for the view from the X, Y and Z direction. Press the button "View from x direction", "View from y direction" or "View from z direction" (see Fig. 3.30). Double click the buttons in order to reverse the view direction:



Fig. 3.30: "View from x/y/z direction" button

With the button "Reset view" (see Fig. 3.31) you can reset the orientation and the offset of the displayed point cloud (see Chapter 3.11).



Fig. 3.31: "Reset view" button

In the "Data acquisition" view (see Chapter 4) you may adjust the size of the 3D-View using the "Maximize 3D-View" and the "Restore 3D-View" button respectively (see Fig. 3.32).



Fig. 3.32: "Maximize/Restore 3D-View" button

If the "Show 3D point information" button (see Fig. 3.33) is selected, you may use the left mouse button in order to select single points in the 3D-View and to display the 3D coordinates of the selected point in a tooltip next to the mouse pointer.



Fig. 3.33: "Show 3D point information" button

With the "Distance between two points" button (see Fig. 3.34) you may interactively measure the distance between two 3D points of the point cloud. To do so, mark the start and the end point using the left mouse button. The distance is displayed as a magenta arrow in the 3D-View. The euclidian distance and the distances in X, Y and Z direction are displayed above the 3D-View in the same color. Left to the button a help text about the functions of the left and right mouse button in the current mode is displayed.



Fig. 3.34: "Distance between two points" button

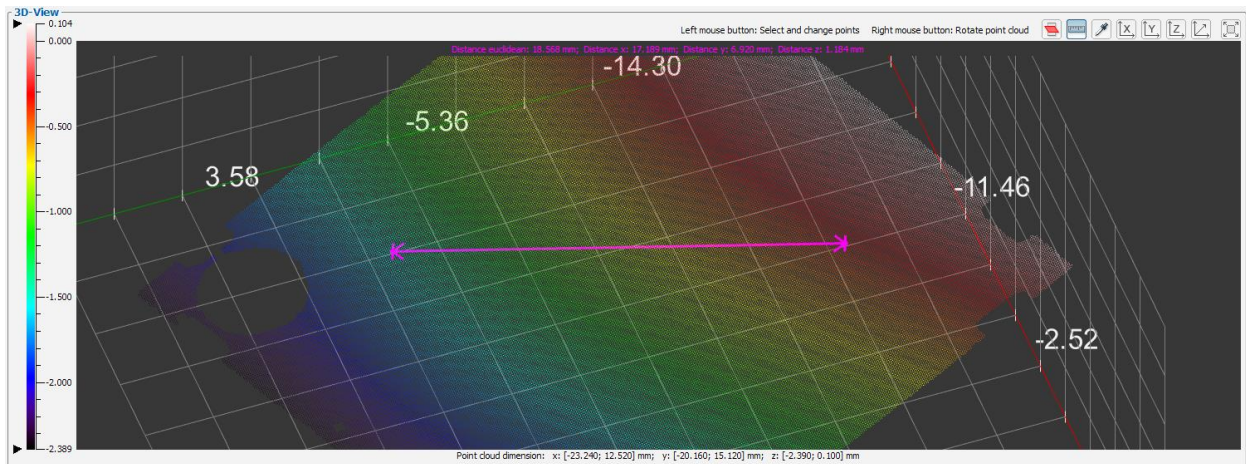

Fig. 3.35: Distance measurement

If the "Show reference plane" button (see Fig. 3.36) is selected, a reference plane is shown. This reference plane is a xy plane with $z=0$. If the reference plane is outside the coordinate system, the reference plane isn't shown.



Fig. 3.36: "Show reference plane" button

3.12 3D-View Settings

The "3D-View settings" dialog box offers you the possibility of configuring the settings for the 2D- and 3D-Views.

- Either select the "Options → 3D-View settings" menu item or press the corresponding button (see Fig. 3.37) in the toolbar in order to access the "3D-View settings" dialog box.



Fig. 3.37: "3D-View settings" button

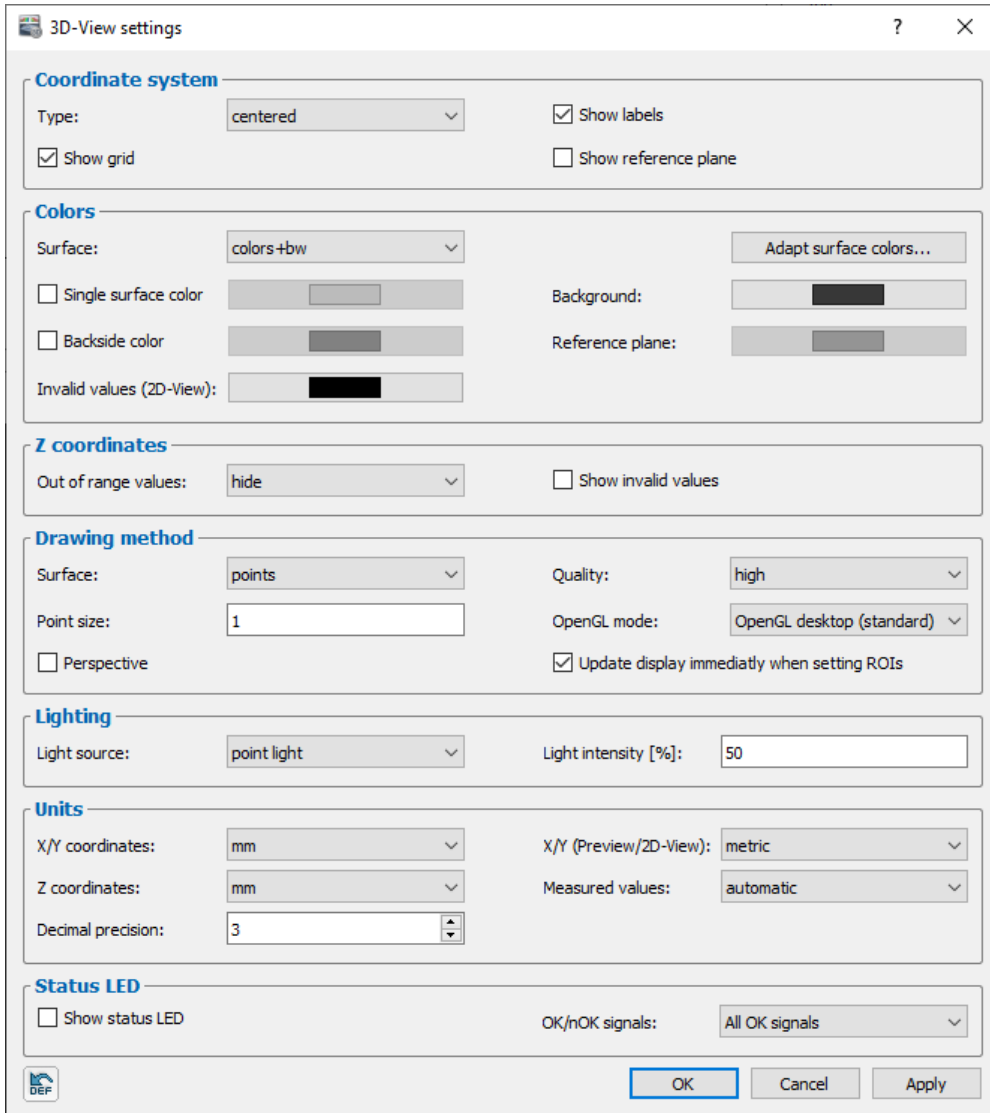

Fig. 3.38: "3D-View settings" dialog box

The following input options are available:

- **Type:** Select the type of the coordinate system displayed in the 3D-View.
 - **none:** No coordinate system is displayed.
 - **normal:** The coordinate system is represented so that the axes intersect at the origin (0/0/0) of the coordinate system.
 - **centered:** The coordinate system is displayed centered.
 - **boxed:** The coordinate system is displayed around the displayed data.
- **Show labels:** Chooses whether the axis legend is to be displayed.
- **Show grid:** Select whether the grid lines are to be displayed (only with type "boxed").
- **Show reference plane:** Select whether the reference plane is displayed.
- **Surface:** Selects a predefined color palette for the texture in the 2D/3D-View (refer also to 8.4).
 - **colors+bw**
 - **grayscale** (grayscale value display)

- **HSV**
 - **alt. colors**
 - **iron 1**
 - **iron 2**
 - **colors**
- **Adapt surface colors...:** You can vary the selected color palette and adapt it to your needs (see Fig. 3.39). The target color value will be stretched between the upper and lower limit. The color values outside the upper and lower limit will be shrunk.
- **Active:** Activate the stretching of the color palette. The automatic color scaling must be deactivated (see below).
 - **Auto color scaling:** Use this parameter in order to deactivate the automatic color scaling. This parameter is identical to the correspondent parameter in the main view (see Chapter 3.8, Color scaling (2D/3D-View))
 - **Max:** The upper limit of the stretched target color value.
 - **Target:** The target color value is stretched between the upper and lower limit.
 - **Min:** The lower limit of the stretched target color value.

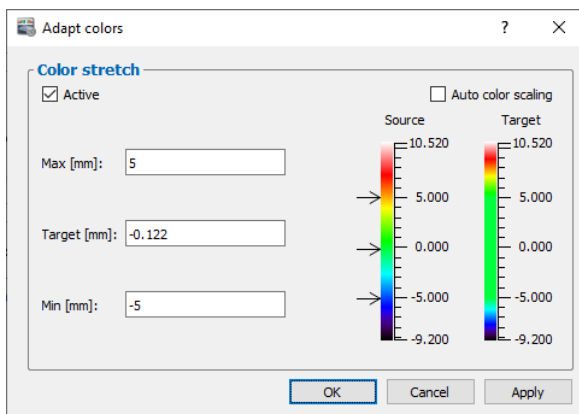

Fig. 3.39: "Adapt colors" dialog box

- **Single surface color:** Instead of a predefined color palette, you may use a single surface color for the texture in the 3D-View.
- **Background:** Select the background color of the 3D-View.
- **Backside color:** You may use a separate surface color for the backside of the point cloud.
- **Invalid values (2D-View):** Select the color of invalid values in the 2D-View.
- **Reference plane:** Select the color of the reference plane in the 3D-View.
- **Out of range values:** Select how the values, whose Z coordinates are outside the scaling selected in the input field "z scaling (3D-View)", should be displayed.
 - **hide:** Values are not displayed.
 - **show saturated:** Values are displayed saturated.
 - **show:** Values are displayed unchanged.
- **Show invalid values:** This parameter is used to display invalid values in the 3D-View.
- **Surface:** With this parameter you select the display method for the 3D-View.
 - **points:** Individual points in the point cloud are displayed.
 - **lines:** Lines are shown.
 - **triangles:** Surface parts are shown which are formed by triangles. The corner points of the triangles are calculated using the points in the point cloud which are located directly adjacent to one another.

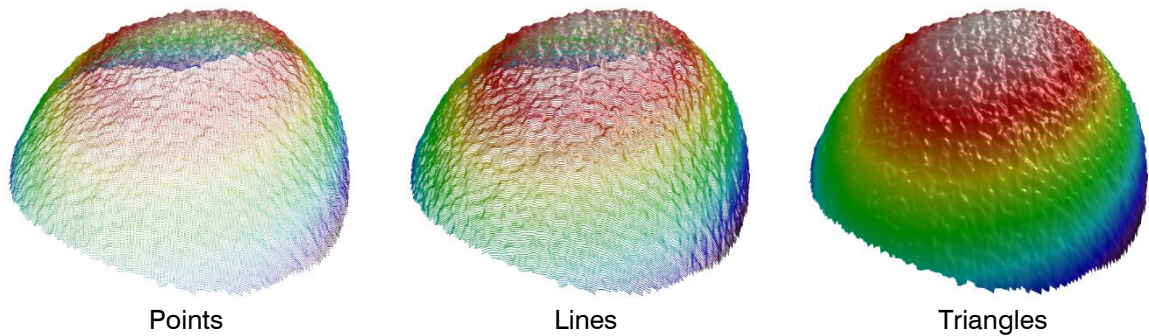

Fig. 3.40: Display methods for the 3D-View

- **Quality:** With this parameter you determine the resolution of the 3D-View.
 - **low:** A maximum of 64 x 64 points are displayed in the 3D-View. If the number of points in the X and/or Y/T direction is larger, the number of points is reduced by average value computation.
 - **normal:** A maximum of 256 x 256 points are displayed in the 3D-View. If the number of points in the X and/or Y/T direction is larger, the number of points is reduced by average value computation.
 - **high:** All points are displayed in the 3D-View. Where many points are involved, this display method needs a high level of system resources.

Note: If the amount of used memory exceeds that of the available memory (see Chapter 3.7), the software may accept user inputs only very slowly and error-free behavior is no longer guaranteed.

- **Point size:** With this parameter you specify the size of the points which are displayed in the 3D-View. This parameter is only active in case of using the "points" option for the "Profiles" parameter.
- **OpenGL mode:** Select the OpenGL implementation that is used for displaying the 3D data.
 - **OpenGL ES:** The display of the 3D data is based on DirectX technology.
 - **OpenGL desktop (standard):** The 3D data are displayed using the vendor-specific driver of the graphics card.

Note: Depending on your PC configuration, it is possible that the 3D data won't be displayed. In this case change the option of the "OpenGL mode" parameter.

Note: When using the "OpenGL ES" mode, the labels of the axes are not available.

- **Perspective:** With this parameter you enable or disable the perspective of the 3D-View.
- **Update display immediately when setting ROIs:** With this parameter you activate or deactivate the immediate updating of the 3D-View and the measurement values when the ROI is changed with the mouse or in the edit fields (see Chapter 3.18.4).
- **Light source:** With this parameter you define the light source:
 - **no light:** Virtual light is deactivated.
 - **point light:** When using a point light source, the light gets emitted from a single point in all directions.
 - **directional light:** When using a directional light source, the light propagates with parallel rays of light in one direction.
- **Light intensity [%]:** Adjust the light intensity of the virtual illumination of the 3D-View.
- **X/Y Coordinates:** Specify the units for the x/y coordinates in the 2D- and 3D-View:
 - **mm:** Millimeter
 - **μm:** Micrometer
- **Z Coordinates:** Specify the units for the z coordinates in the 2D- and 3D-View:
 - **automatic:** Depending on the used sensor type, the unit is assigned automatically (reflectCONTROL: μm, surfaceCONTROL: mm).
 - **mm:** Millimeter
 - **μm:** Micrometer
- **X/Y (Preview/2D-View):** Specify the unit for the x and y axes in the preview and 2D-View:

- **metric:** Millimeter or micrometer, depending on the "X/Y Coordinates setting" (see above)
- pixel
- **Measured values:** Specify the units for the measured values in the individual measuring programs and result views:
 - **automatic:** Depending on the used sensor type, the unit is assigned automatically (reflectCONTROL: μm , surfaceCONTROL: mm).
 - **mm:** Millimeter
 - **μm :** Micrometer
- **Decimal precision:** Specify the number of decimal places displayed for the measured values.
- **Show status LED:** Activate the display of a status LED that appears in the upper right corner of the 3D-View in the "Data Acquisition" and "Results" views.
- **OK/nOK signals:** Select a control signal for the status LED that is derived from the evaluated measured values (see Chapter 7.3). The status LED is OK (green) if:
 - **All OK signals:** All assessed measured values are deemed OK.
 - **Any OK signal:** At least one assessed measured value is deemed OK.
 - **OK x:** Assessed measured value x is deemed OK.

In the lower left corner you will find the "**Reset to factory default**" button: Use this button to reset all settings to factory default.



Fig. 3.41: Button "Reset to factory default"

Confirm your settings with OK.

3.13 Description of the 2D Profile View

The 2D Profile View visualizes the selected 2D profile of a 2D-Measuring Program.

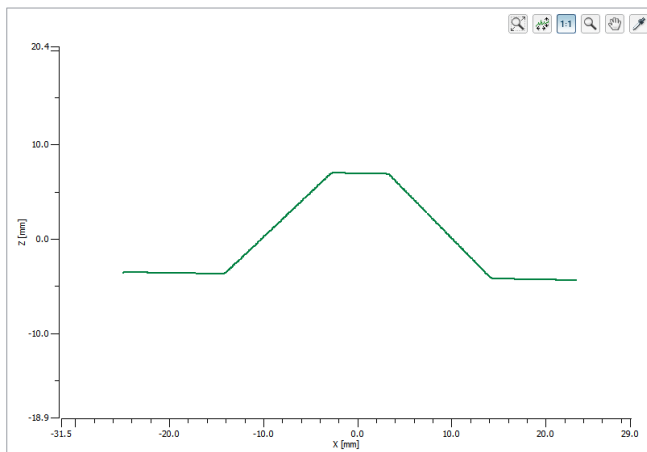

Fig. 3.42: 2D Profile View

- **Zooming in/out the range:** Enable the "Zoom" mode by pressing the "Zoom" button (see Fig. 3.43: "Zoom" button). Press the left mouse button and keep it pressed to draw out a range. The 2D Profile View then completely visualizes the marked range when you release the mouse button. You can mark a range as often as required and zoom in the marked range. You use this function to display certain ranges with particular detail. Alternatively, you can use the mouse wheel to zoom in and out.



Fig. 3.43: "Zoom" button

- **Fit to window:** In order to display the data completely in the 2D Profile View, press the "Fit to window" button (see Fig. 3.44)



Fig. 3.44: "Fit to window" button

- **Moving of the range:** Enable the "Move" mode by pressing the "Move" button (see Fig. 3.45: "Move" button). Press the left mouse button and move the range. Release the mouse button.



Fig. 3.45: "Move" button

- **Display extended information of a point:** Press the correspondent button (see Fig. 3.46: "Pipette" button) to activate or deactivate the "Pipette" mode. Press the left mouse button on the desired point. The information for the point will now be displayed in a tooltip next to the mouse pointer.



Fig. 3.46: "Pipette" button

- **Automatic scaling:** You activate or deactivate the automatic scaling of the 2D-display by pressing this button (see Fig. 3.47). If automatic scaling is activated, the 2D Profile View will be automatically adapted to the minimum and maximum coordinates of the displayed profile.



Fig. 3.47: Button "Automatic scaling"

- **Keep aspect ratio:** Activating this option the 2D Profile View is scaled so that the real aspect ratio of the displayed profile is retained. Deactivating this option the scaling is adapted separately to the actual values for the X and Y axes.



Fig. 3.48: Button "Keep aspect ratio"

3.14 Structure of a Measuring Program

The following describes the basic structure of a measuring program:

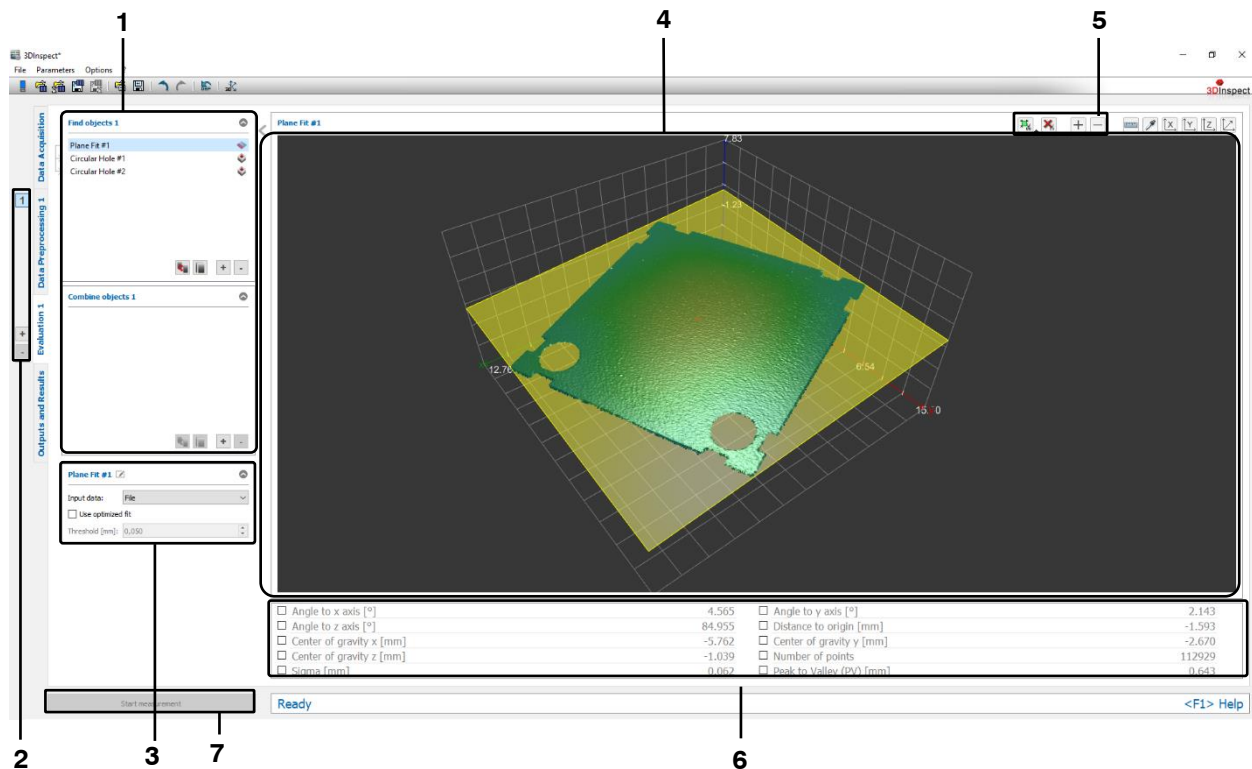

Fig. 3.49: Structure of a measuring program

1 List of active measuring programs: The active measuring programs are listed in this section. You can add and remove measuring programs (see Chapter 3.15). When you mark a program in the list, the relevant settings of the measuring program, the associated point cloud with the 3D results and the scalar result values of the program will be displayed.

2 Measuring program groups: You may add and remove measuring program groups and select existing program groups in this section (see Chapter 3.17).

3 Measuring program settings: This section contains the settings for the currently selected measuring program. Here, you can rename the measuring program (see Chapter 3.18.1), select the input data for the measuring program (see Chapter 3.18.3), specify the measuring task of the selected program (see Chapter 3.18.2) and configure further parameters for the measuring program (see Chapter 3.18.8).

4 2D Profile View/3D-View: This section displays the input data and selection ranges for the measurement. Depending on the measuring program, the output data or the calculated results are also displayed. If the measuring program is a 2D-Measuring program the 2D Profile View is shown (see Chapter 3.13), else the 3D-View is visible (see Chapter 3.11).

5 "Measurement" toolbar: In this section you can define or adjust a selection range in the 3D-View or 2D Profile View in which the measurement is to be carried out (see Chapter 3.18.4 and Chapter 3.18.5). You can also add selection ranges (see Chapter 3.18.7) in order to define up to four selection ranges per measuring program and/or to remove existing ranges.

6 Measurement results: This section displays the scalar measurement results of the selected program. In this section you can select which measurement results are to be made available later for calculation, assessment, output and logging.

7 "Start measurement" button: Click on this button to perform a measuring operation, calculate the measurement results and display the measured point cloud and the measured values.

3.15 Adding/Removing Measuring Programs

In the "Data preprocessing" and "Evaluation" views, you have the option to add and/or remove measuring programs for the 3D measurement. First, the measuring programs in the "Data preprocessing" view and then the programs listed in the "Evaluation" view are listed. In the individual views, the measuring programs are listed in "top" to "bottom" order. The measuring programs can access results of previous measuring programs, but not the other way round ("waterfall model"). The dependencies of the currently selected measuring program on other measuring programs are represented graphically as arrows.

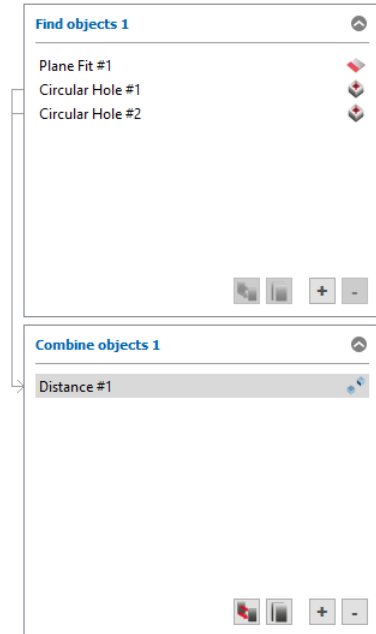

Fig. 3.50: List of active measuring programs ("Evaluation" view)

- Adding a measuring program:

➤ Click on the "+" button (see Fig. 3.50).

A drop-list of available measuring programs appears in the relevant region:

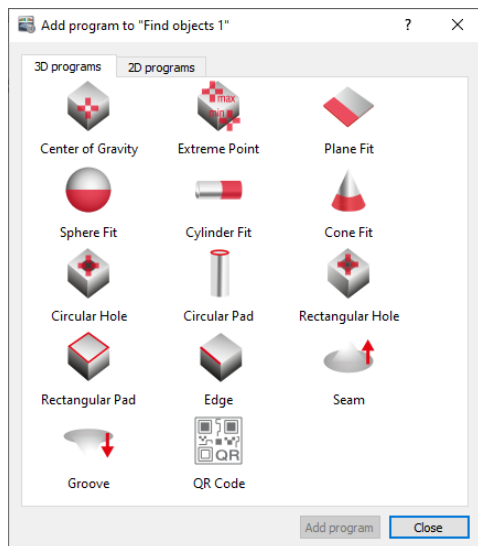

Fig. 3.51: List of measuring programs

- Choose whether a 2D or 3D measuring program is needed.
- Click on the desired measuring program and then on "Add program", or double-click on the desired program in order to add it to the list of active measuring programs.
- You can add other measuring programs if desired.
- Confirm the dialog with OK.

The selected programs have now been added to the end of the list of measuring programs and the measuring program added last is selected.

- Removing a measuring program:

- Select the measuring program you want to remove from the list.
- Click on the "-" button (see Fig. 3.50).

The selected measuring program is removed from the list of active measuring programs.

Note: If the results of the measuring program to be deleted are used in subsequent programs, a dialog for confirming the deletion will appear.

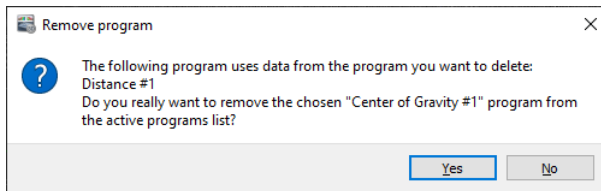

Fig. 3.52: "Remove program" dialog

3.16 Moving/Duplicating a Measuring Program

You have the option of moving measuring programs in the program list after they have been added:

- Click on the desired program in the program list, hold the mouse button down, move the program to the desired position and then let go of the mouse button.

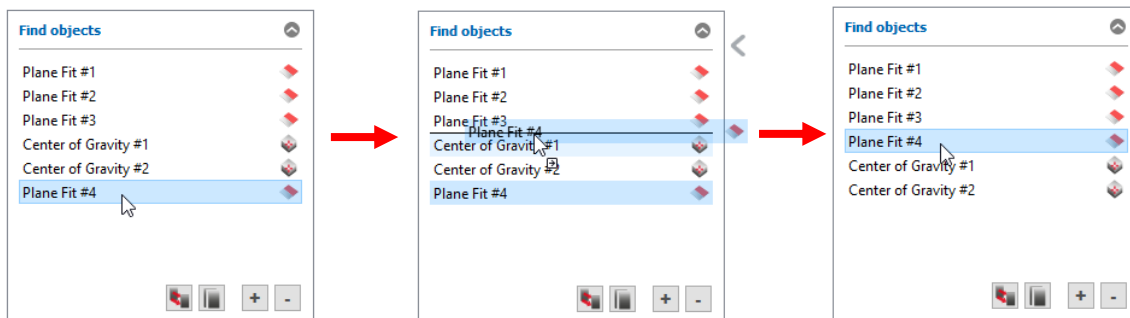

Fig. 3.53: Moving a measuring program

If you are using multiple measuring program groups, you have the option of moving measuring programs to another program group subsequently. Additionally, you may duplicate existing measuring programs. To do so, use the correspondent buttons.

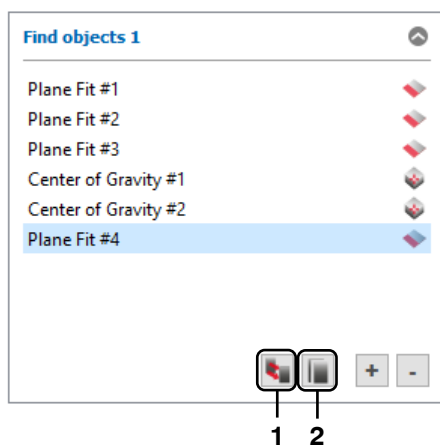

Fig. 3.54: Duplicate measuring program / Move measuring program to another program group

- 1: Move Measuring program to another program group
- 2: Duplicate measuring program

3.17 Adding/Removing Measuring Program Groups

If a large number of measuring programs are required for a measuring task, it is advantageous to split the measuring programs into measuring program groups. Each measuring program group consists of the "Data preprocessing", "Find objects" and "Combine objects" sub groups. The program groups are processed one after another, and inside a program group the sub groups are processed in the following order: "Data preprocessing" → "Find objects" → "Combine objects". 3DInspect gives you the option of adding, removing and selecting measuring program groups. The list of active measuring programs of the currently selected measuring program group is displayed. Up to eight measuring program groups can be created.

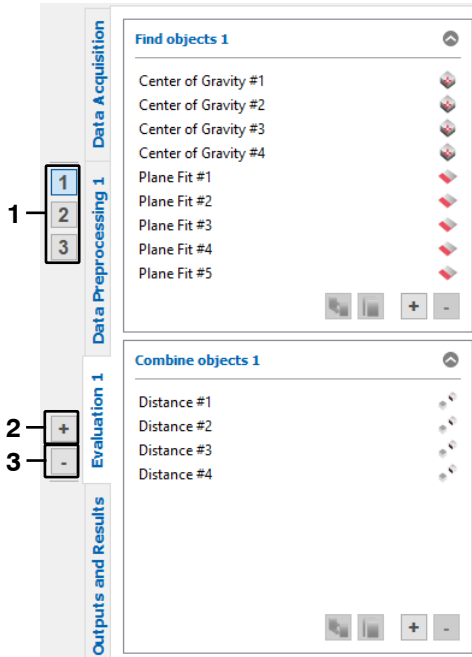

Fig. 3.55: Measuring program groups

- 1: Select current measuring program group
- 2: Add a measuring program group
- 3: Remove the current measuring program group

3.18 Configuring a Measuring Program

In order for the desired measurements to be carried out in the individual measuring programs, you must first set the input data, selection ranges and parameters. The setting options vary depending on the individual measuring program. In principle, the measurement configuration process can be split into six steps:

- Rename measuring program (optional, see Chapter 3.18.1).
- Specify measuring task (optional, depending on measuring program, see Chapter 3.18.2).
- Select input data (see Chapter 3.18.3).
- Select 2D/3D points (optional): Selection of up to four ranges within which the measurement is to be carried out (see Chapter 3.18.4 and 3.18.5).
- Set the parameters for the measuring program (optional, depending on measuring program, see Chapter 3.18.8)
- Select the measured values to be used further (see Chapter 3.18.9).

3.18.1 Renaming a Measuring Program

When using multiple measuring programs, it is often helpful to rename them in order to get a clear assignment later when selecting measured values. In order to rename a measuring program, proceed as follows:

- In the configuration section of the measuring program, click on the edit symbol, which is located to the right of the current name of the program. An input field for editing the name then appears.
- Enter the desired name and confirm with Enter.

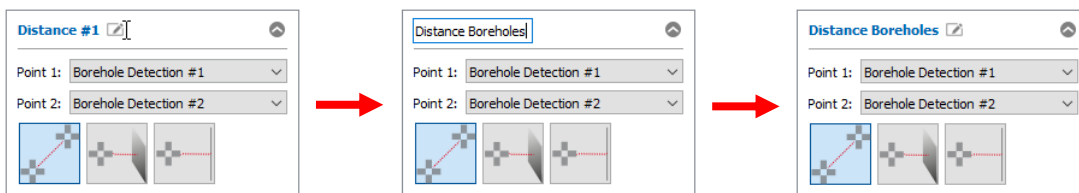

Fig. 3.56: Renaming a measuring program

Hinweis: If you enter an empty name, the standard name for the measuring program will be used automatically.

3.18.2 Specifying a Measuring Task

Some measuring programs require a more precise specification of the measuring task. You can do this in the sections of the individual measurement packages provided for this purpose (see Fig. 3.57). The procedure for specifying the measuring task will be explained in the following using the example of the "Angle difference" program.

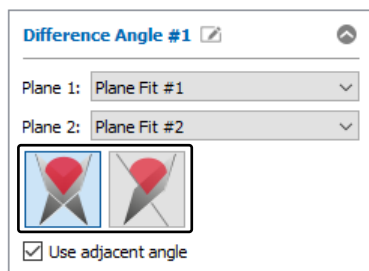

Fig. 3.57: Measuring task for the "Angle" program

The "Angle" measuring program is used to determine the angle between two geometric objects. You can choose whether the angle between two planes or between a plane and a straight line should be determined.

Note: The available input data (see Chapter 3.18.3) may differ for the individual measuring tasks depending on the measuring program.

3.18.3 Selecting Input Data

The measuring programs require input data to run the relevant algorithm. Depending on the type of measuring program, this may be a point cloud, a 2D profile or geometric objects of previous measuring programs. When a new measuring program is added, the most recent available point cloud or the most recent available geometric objects are automatically selected. However, if required, you can select input data from other measuring programs.

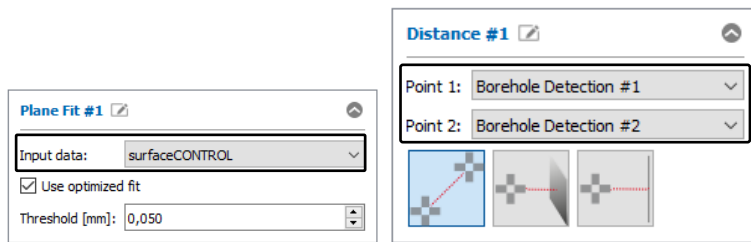

Fig. 3.58: "Plane Fit" and "Distance" input data

Note: Only results of previous measuring programs can be used as input data. Results of subsequent measuring programs cannot be used.

Note: The order of measuring programs can be changed at a later time (see Chapter 3.16).

3.18.4 Selecting 3D Points

Some 3D measuring programs provide the option of specifying up to four region of interests (ROIs) within which the measurement shall take place and thus hide the remaining 3D points. Points outside these ROIs are not taken into account during the measurement and are shown in gray. You can choose from two types of ROIs:

- **Cuboid**
- **Cylinder**

For both types there are two modes available:

- **Use points within a ROI:** Define a ROI in the 3D-View. Points inside this ROI are taken into account during the measurement. Points outside this ROI are not taken into account during the measurement.
- **Use points outside a ROI:** define a ROI in the 3D-View. Points outside this ROI are taken into account during the measurement. Points inside this ROI are not taken into account during the measurement.

If you want to use all 3D points of the current point cloud for the measurement, you can skip this step.

In order to select the type (Cuboid/Cylinder) and the mode (Use points inside/outside the ROI), proceed as follows:

- Open the "Region of interest options" context menu. Click on the corresponding icon to the right of the "Set region of interest" button (see Fig. 3.59).
- Select the desired type and mode from the context menu (see Fig. 3.59).

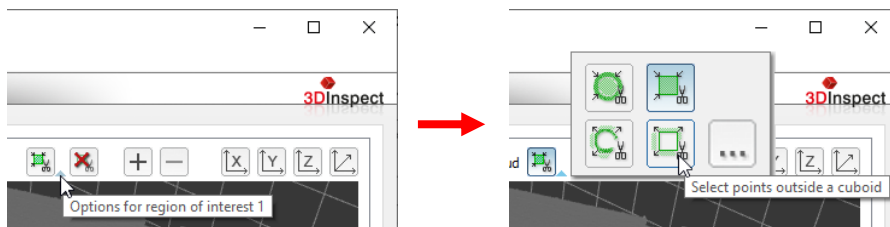

Fig. 3.59: "Region of interest options" context menu (Cuboid/Cylinder, Use points inside/outside the ROI)

Note: By default, the "Cuboid" type and the "Use points inside the selection range" mode are active.

After you have selected the type and mode, you can specify the ROI for the measurement:

If you haven't already, click on the "Set region of interest" button (see Fig. 3.60) in the "Measurement" toolbar. You are now in "Set region of interest for 3D points" mode. The button remains pressed down and the ROI is shown semi-transparently in the 3D-View if it is within the range displayed.



Fig. 3.60: "Set region of interest" button (Cuboid/Cylinder, Use points inside/outside the ROI)

Note: By default, the entire point cloud is used for the measurement. The cuboid/cylinder in the 3D-View is therefore not visible immediately after activation of the "Set region of interest" mode.

You can now set the ROI in the 3D-View using your mouse. There are two options for this:

- Setting a new ROI:

- First, set the range in the x/y direction. To do this, rotate the view so that you are viewing the point cloud from the z direction. Use the corresponding button for this purpose.

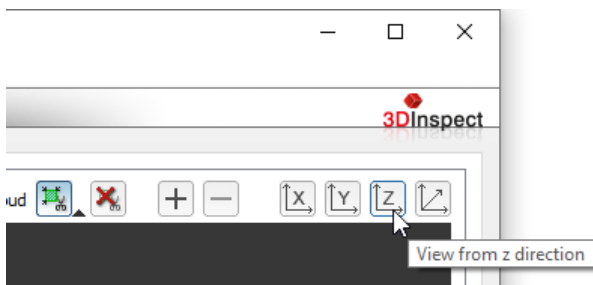

Fig. 3.61: Viewing the point cloud from the z direction

- Move the cursor to any corner of the ROI you want to set.
- Now mark out the ROI to be set. To do this, press and hold down the left mouse button. Move the cursor to the opposite corner of the ROI you want to set.
- Release the mouse button. The marked ROI will then be adopted.

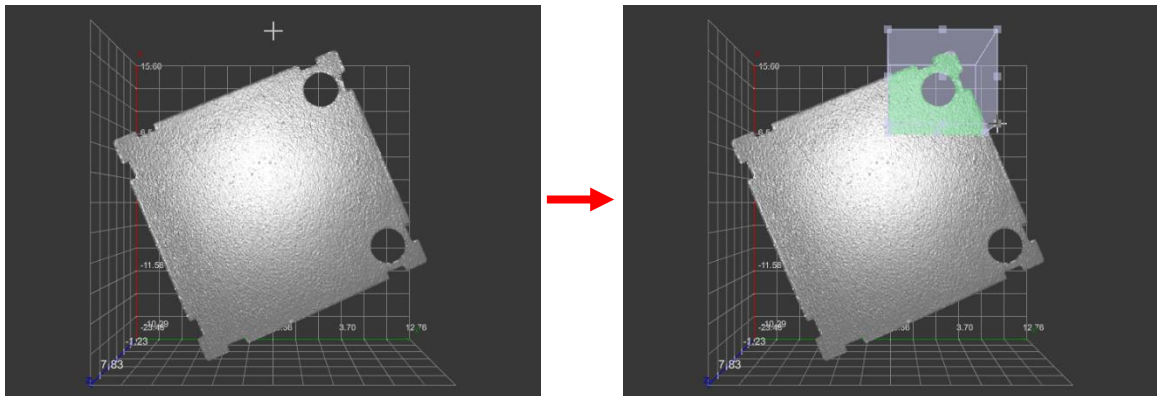

Fig. 3.62: Setting the complete ROI (x/y range)

- If required, you can also define the ROI in the z direction. To do this, first rotate the view so that you are viewing the point cloud from the x or alternatively the y direction. Use the corresponding button for this purpose.
- You can then either modify the current box by dragging the upper and/or lower edges thereof (see below, "Modifying an existing ROI") or define the ROI again from scratch. Move the cursor to any corner of the ROI you want to set.
- Now mark out the ROI to be set. To do this, press and hold down the left mouse button. Move the cursor to the opposite corner of the ROI you want to set.
- Release the mouse button. The marked ROI will then be adopted.

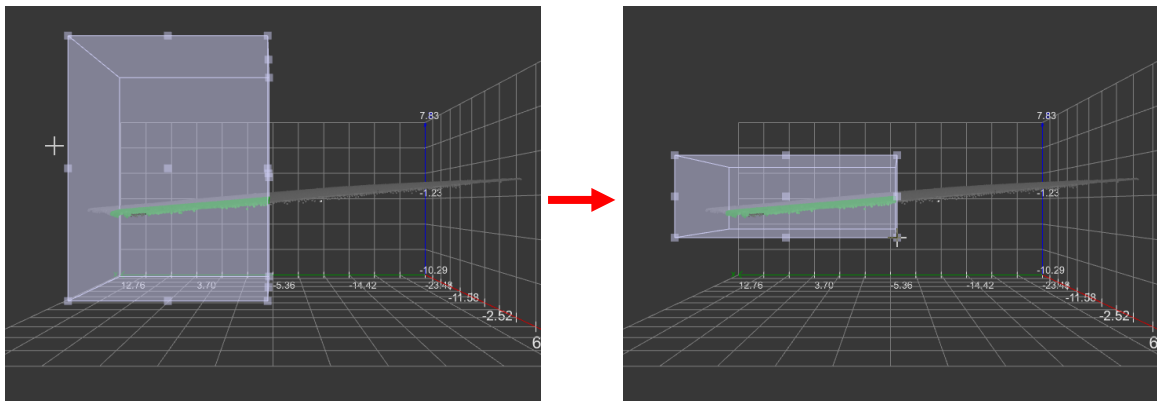

Fig. 3.63: Setting the complete ROI (z range)

Note: When setting the ROIs, it is often helpful to deactivate the perspective 3D-View (see Chapter 3.12, "Perspective" parameter).

Note: If you accidentally start a new ROI while defining another, you can undo this by using the Escape key or by simultaneously pressing the left and right mouse button.

Note: If "Setting region of interest" mode is active, you can rotate and move the 3D-View using the right mouse button (see Chapter 3.11).

- Modifying an existing ROI (drag and drop)::

- Rotate the display so that you can clearly see the ROI you want to change.
- Move the cursor to any corner or side of the ROI displayed so that the cursor appears as a double arrow.
- Now press and hold down the left mouse button. Then move the cursor to the desired position. The side or corner of the ROI changes with the position of the cursor.
- Release the mouse button.

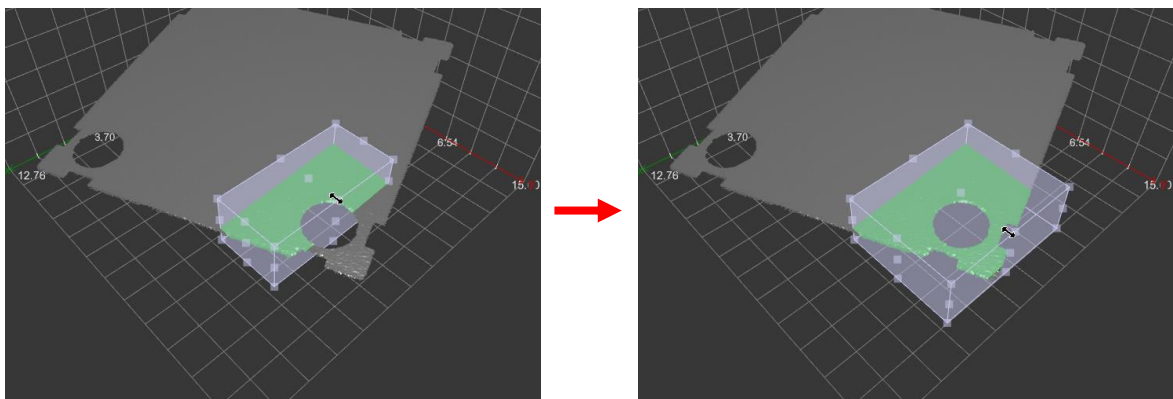

Fig. 3.64: Modifying the ROI

Note: If you accidentally modify an existing ROI before completing the mouse action, you can undo this using the Escape key.

As well as using the mouse, you also have the option to manually edit the values for the ROI in which the measurement is to take place.

- Open the context menu for the desired ROI (see above, Fig. 3.59).
- Click on the "..." button.

The "Edit region of interest" dialog appears.

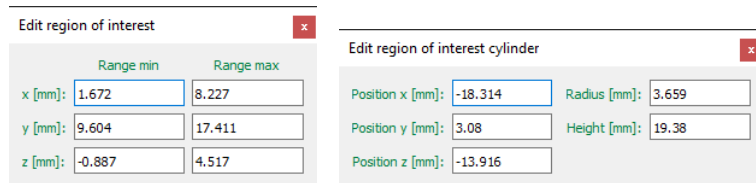

Fig. 3.65: "Edit region of interest" dialog

Use the input fields to manually edit the values for the ROI.

3.18.5 Selecting 2D Points

Some 2D-measuring programs provide the option of specifying up to four region of interests (ROIs) within which the measurement shall take place and thus hide the remaining 2D points. Points outside these ROIs are not taken into account during the measurement and are shown in gray. You can choose from two modes:

- **Use points within a ROI:** Define a ROI in the 2D Profile View. Points inside this ROI are taken into account during the measurement. Points outside this ROI are not taken into account during the measurement.
- **Use points outside a ROI:** define a ROI in the 2D Profile View. Points outside this ROI are taken into account during the measurement. Points inside this ROI are not taken into account during the measurement.

If you want to use all 2D points of the current profile for the measurement, you can skip this step.

In order to select the mode (Use points inside/outside the ROI), proceed as follows:

- Open the "Region of interest options" context menu. Click on the corresponding icon to the right of the "Set region of interest" button (see Fig. 3.66).
- Select the desired mode from the context menu (see Fig. 3.66).

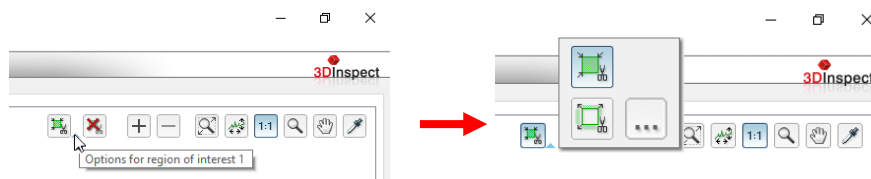

Fig. 3.66: "Region of interest options" context menu (Use points inside/outside the ROI)

Note: By default, the "Use points inside the selection range" mode is active.

After you have selected the mode, you can specify the ROI for the measurement:

If you haven't already, click on the "Set region of interest" button (see Fig. 3.67) in the "Measurement" toolbar. You are now in "Set region of interest" mode. The button remains pressed down and the ROI is shown in the 2D Profile View if it is within the range displayed.



Fig. 3.67: "Set region of interest" button (Use points inside/outside the ROI)

Note: By default, the entire profile is used for the measurement. The rectangle in the 2D Profile View is therefore not visible immediately after activation of the "Set region of interest" mode.

You can now set the ROI in the 2D Profile View using your mouse. There are two options for this:

- Setting a new ROI:
 - Move the cursor to any corner of the ROI you want to set.
 - Now mark out the ROI to be set. To do this, press and hold down the left mouse button. Move the cursor to the opposite corner of the ROI you want to set.
 - Release the mouse button. The marked ROI will then be adopted.

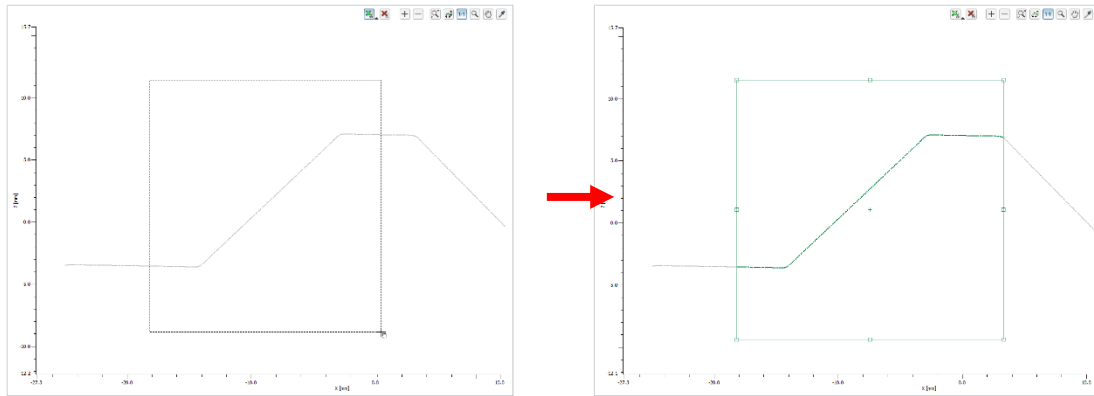

Fig. 3.68: Setting the complete ROI

- Modifying an existing ROI (drag and drop):
 - Move the cursor to any corner or side of the ROI displayed so that the cursor appears as a double arrow.
 - Now press and hold down the left mouse button. Then move the cursor to the desired position. The side or corner of the ROI changes with the position of the cursor.
 - Release the mouse button.

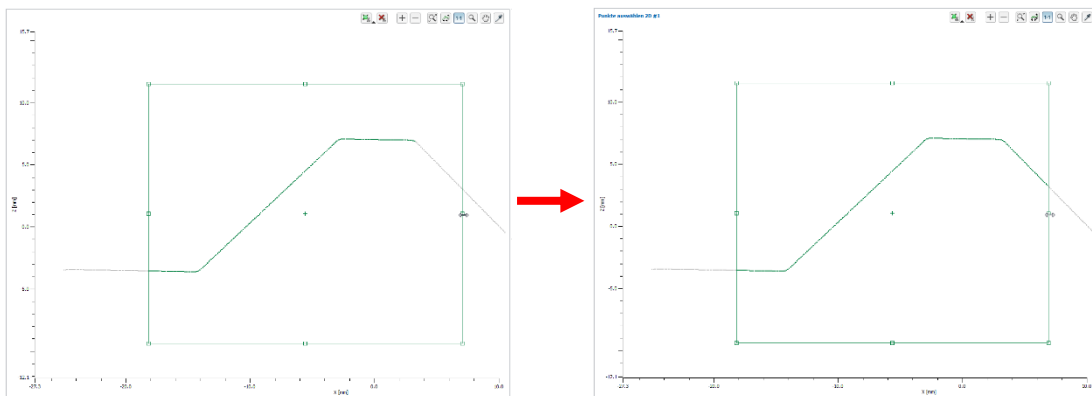

Fig. 3.69: Modifying the ROI

As well as using the mouse, you also have the option to manually edit the values for the ROI in which the measurement is to take place.

Open the context menu for the desired ROI and click on the "..." button (see above, Fig. 3.66) or press the right mouse button in the profile view.

The "Edit region of interest" dialog appears.

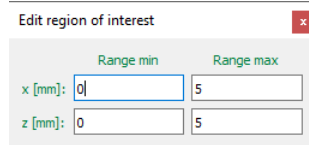

Fig. 3.70: "Edit region of interest" dialog

Use the input fields to manually edit the values for the ROI.

3.18.6 Resetting the Region of Interest

Using the "Reset region of interest" button (see Fig. 3.71), you can reset the ROI for the measurement (see Chapter 3.18.4) and thus use the entire measuring range for the measurement.



Fig. 3.71: "Reset region of interest" button

3.18.7 Adding/Removing Region of Interests

Depending on the measuring task and type of object, it is often helpful to use multiple ROIs for a measurement. 3DInspect supports up to four ROIs per measuring program.

Adding a ROI:

- ➡ Click on the "+" button in the "Measurement" toolbar (see below).

A new ROI will now be available. The ROI is activated and can be set in the 2D- or 3D-View.

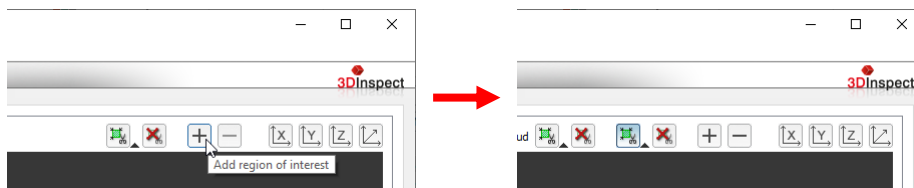

Fig. 3.72: Adding a ROI

Removing a ROI:

- ➡ Activate the ROI you want to remove in the "Measurement" toolbar.
- ➡ Click on the "-" button in the toolbar.

The ROI will then be removed.

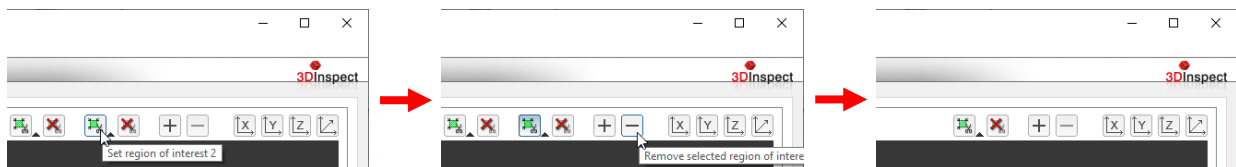

Fig. 3.73: Removing a ROI

3.18.8 Setting the Parameters for a Measuring Program

Some measuring programs offer other parameters in addition to the choice of type of input data (see Chapter 3.18.3) and the specification of the measuring task (see Chapter 3.18.2). These parameters can be configured in the input field of the parameters for the relevant measuring program.

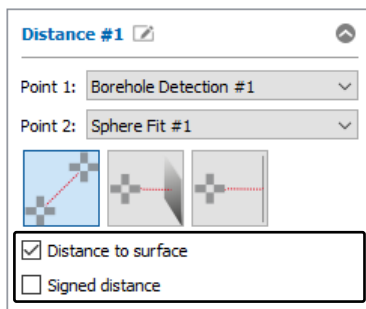

Fig. 3.74: Parameters for the "Distance" measuring program

3.18.9 Selecting Measured Values to be Used Further

The individual measuring programs show the current measured values below the 3D-View:

<input type="checkbox"/> Center x [mm]	-20.017	<input type="checkbox"/> Center y [mm]	18.918
<input type="checkbox"/> Center z [mm]	-17.839	<input checked="" type="checkbox"/> Radius [mm]	7.702
<input type="checkbox"/> Number of points	7343	<input type="checkbox"/> Sigma [mm]	0.175
<input type="checkbox"/> Peak to Valley (PV) [mm]	6.720		

Fig. 3.75: Measured values for the "Sphere fit" program

In this section, you can select which measured values are to be used again later. The measured values selected here can be used later for calculation, OK/nOK assessment, logging and output.

3.19 Measuring Program Output Data

For the parameterization of some measuring programs additional two and three dimensional geometrical objects are required, which are created by previous measuring programs. The selectable objects are points and lines in the two and three dimensional space as well as planes in the three dimensional space. These simple objects may also be extracted from more "complex" objects. The following chapters describe the possible source objects and measuring programs that provide them for each object type.

3.19.1 Points

The output points of measuring programs may be used to parametrize subsequent measuring programs.

Note: Two dimensional points can also be used as input for three-dimensional measuring programs.

Following measuring programs provide points:

- **Point 3D:**
 - **Point:**
 - "Center of Gravity" measuring program (see Chapter 6.1.1)
 - "Extreme Point" measuring program (see Chapter 6.1.2)
 - "Seam" measuring program (see Chapter 6.1.12)
 - "Groove" measuring program (see Chapter 6.1.13)
 - "Object Intersection" measuring program (see Chapter 6.2.3)
 - "Perpendicular Point" measuring program (see Chapter 6.2.4)
 - "Midpoint" measuring program (see Chapter 6.2.5)
 - **Straight Line (Center of gravity):**
 - "Edge" measuring program (see Chapter 6.1.11)
 - **Plane (Center of gravity):**
 - "Plane Fit" measuring program (see Chapter 6.1.3)
 - "Plane Creation" measuring program (see Chapter 6.2.7)
 - **Rectangle (Mid point):**
 - "Rectangular Hole" measuring program (see Chapter 6.1.9)
 - "Rectangular Pad" measuring program (see Chapter 6.1.10)
 - **Cone (Tip of cone):**
 - "Cone Fit" measuring program (see Chapter 6.1.6)
 - **Sphere (Center point):**
 - "Sphere Fit" measuring program (see Chapter 6.1.4)
 - **Circle (Center point):**

- "Circular Hole" measuring program (see Chapter 6.1.7)
 - "Circular Pad" measuring program (see Chapter 6.1.8)
- Point 2D:
 - Point:
 - "Center of Gravity 2D" measuring program (see Chapter 6.1.15)
 - "Extreme Point 2D" measuring program (see Chapter 6.1.16)
 - "Seam 2D" measuring program (see Chapter 6.1.21)
 - "Groove 2D" measuring program (see Chapter 6.1.22)
 - "Circle Seam 2D" measuring program (see Chapter 6.1.23)
 - "Circle Groove 2D" measuring program (see Chapter 6.1.24)
 - "Gap 2D" measuring program (see Chapter 6.1.25)
 - "Object Intersection 2D" measuring program (see Chapter 6.2.10)
 - "Midpoint 2D" measuring program (see Chapter 6.2.11)
 - Straight Line (Center of gravity):
 - "Line Fit 2D" measuring program (see Chapter 6.1.17)
 - Circle (Center point):
 - "Circle Fit 2D" measuring program (see Chapter 6.1.18)
 - "Corner Radius 2D" measuring program (see Chapter 6.1.19)
 - "Roundness 2D" measuring program (see Chapter 6.1.20)

3.19.2 Straight Line

The output lines of measuring programs may be used to parametrize subsequent measuring programs.

Note: Two dimensional lines can also be used as input for three-dimensional measuring programs.

Following measuring programs provide straight lines:

- Straight line 3D:
 - Line:
 - "Edge" measuring program (see Chapter 6.1.11)
 - "Line Creation" measuring program (see Chapter 6.2.6)
 - "Object Intersection" measuring program (see Chapter 6.2.3)
 - Cylinder (Longitudinal axis):
 - "Cylinder Fit" measuring program (see Chapter 6.1.5)
 - Cone (Longitudinal axis):
 - "Cone Fit" measuring program (see Chapter 6.1.6)
- Straight line 2D:
 - "Line Fit 2D" measuring program (see Chapter 6.1.17)

3.19.3 Plane

The output planes of measuring programs may be used to parametrize subsequent measuring programs.

Following measuring programs provide planes:

- Plane:
 - "Plane Fit" measuring program (see Chapter 6.1.3)
 - "Plane Creation" measuring program (see Chapter 6.2.7)

3.19.4 Circle

The output circles of measuring programs may be used to parametrize subsequent measuring programs.

Following measuring programs provide circles:

- Circle 2D:
 - "Circle Fit 2D" measuring program (see Chapter 6.1.18)
 - "Corner Radius 2D" measuring program (see Chapter 6.1.19)
 - "Roundness 2D" measuring program (see Chapter 6.1.20)

3.20 Saving and Loading Parameters

3DInspect allows you to save and load parameters. For example, you can save parameters for different measuring settings and therefore configure the measurement system for different measuring tasks. In addition, you can also specify different tolerances for a single measuring task. You can simplify the configuration of a new measuring task by making stepwise refinements.

Once you have saved all the parameters for measurement settings you can load them again later on. You can save the parameters for as many measuring tasks as you like.

3.20.1 Saving Parameters to File

In order to save the parameters of the active measuring programs, either select the menu item "Parameters → Save parameters" or press the corresponding button (see Fig. 3.76) in the "General" toolbar.



Fig. 3.76: "Save parameters to file" button

If a parameter file is already open (the name of the current file is displayed in the title bar), the parameters are saved in this file. Select the "Save parameters as" menu item to save the parameters in a new file. A standard Windows dialog is displayed for selection of the path and file name for saving the parameters. The file name has the extension ".me3dparam". The parameters are saved in the selected file after confirmation of the dialog.

3.20.2 Loading Parameters from File

In order to load previously saved parameters of measuring programs, either select the menu item "Parameters → Load parameters" or press the corresponding button (see Fig. 3.77) in the "General" toolbar.



Fig. 3.77: "Load parameters from file" button

A standard Windows dialog is displayed for selection of the path and file name from which the parameters should be loaded. The file name has the extension ".me3dparam". The parameters are loaded after confirmation of the dialog. The filename of the loaded file will be displayed in the title bar.

Note: Use the "Recent parameters" menu item to load and apply previously saved or loaded parameters. (see Fig. 3.83).

3.20.3 Resetting Parameters to Factory Default

In order to reset the parameters to factory default, either select the menu item "Parameters → Reset parameters to factory default" or press the corresponding button (see Fig. 3.78) in the "General" toolbar.



Fig. 3.78: "Reset" button

A dialog is displayed (see Fig. 3.79) where you can select which parameters should be reset.

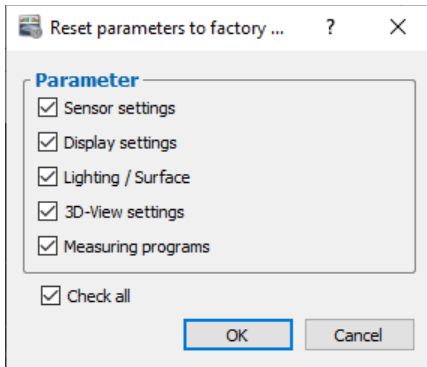

Fig. 3.79: "Reset parameters" dialog box

The following parameters can be reset:

- **Sensor settings:** The parameters of the used sensor (see Chapter 3.4.1, 3.4.3, 3.4.4, 3.4.7).
- **Display settings:** The settings for the scaling of the 2D/3D-View (see Chapter 3.8).
- **Lighting/Surface:** The settings for the lighting and surface (see Chapter 3.10).
- **3D-View settings:** The 3D-View settings (see Chapter 3.12).
- **Measuring programs:** All measuring programs will be removed from the active program list. (see Chapter 3.13)

- ➡ Press the "Check all" button in order to select all parameter types. Press the "Check all" button in order to deselect all parameter types again.
- ➡ Press "OK" in order to reset the selected parameters.

3.21 Undo/Restore

3DInspect provides the possibility to undo and restore changes of settings and parameters. The tooltip of the corresponding button in the toolbar (see Fig. 3.80) shows the change which is undone or restored. When loading new parameters or connecting to a new sensor, the history will be deleted.



Fig. 3.80: Undo/Restore

3.22 User management

3D Inspect offers the possibility to work with two different user levels. The usage of the user levels can be activated in the main settings (see Chapter 3.25). Use the "User → Log on" or "User → Log off" menu item to log on or of a user. You may use the "User → User management" menu item in order set up new users. The following users and user levels are defined by default:

Level	Name	Password	Description
Administrators	Administrator	***	Is not used.
Managers	Manager	Manager	Has access to all functions of 3DInspect
Users / logged off	User	User	Has access to the following function: <ul style="list-style-type: none"> - Activate all views - Change between Online and Offline mode - Load / Reset parameters - Save point cloud manually - Activate / Deactivate automatic saving of point clouds - Configure 3D-View - Configure some main settings

3.23 Menu Bar

A summary of the menu bar functions (see Fig. 3.81) can be seen in the following.

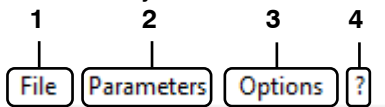

Fig. 3.81: Menu bar

1 - File:

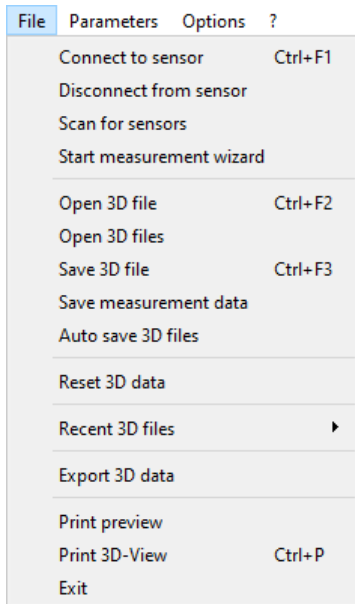

Fig. 3.82: "File" menu

- **Connect to sensor:** Selects a sensor which is connected to the PC as data source (see Chapter 3.4).
- **Disconnect from sensor:** Disconnects the connected sensor.
- **Scan for sensors:** Identifies all sensors which are located in the same subnet as the PC. This function is performed automatically when you start the software.
- **Start measurement wizard:** Starts the measurement wizard for surfaceCONTROL/reflectCONTROL (see Chapter 3.4.8)
- **Open 3D file:** Selects a file in which a point cloud have been saved previously as data source (see Chapter 3.5).
- **Open 3D files:** Loads multiple files in which point clouds have been saved (see Chapter 3.5).
- **Save 3D file:** Saves the point cloud which has been lastly transferred by the connected sensor (see Chapter 3.6.1).
- **Save camera images:** Saves the camera images which have been lastly transferred by the connecte sensor (see Chapter 3.6.1).
- **Save measurement data:** Saves the point cloud which has been lastly transferred by the connected sensor and the correspondent 2D measurement data (see Chapter 3.6.1).
- **Auto save 3D files:** Activates or deactivates the automatic saving of point clouds after each measuring operation (see Chapter 3.6.2 and 3.25, section 4).
- **Reset 3D data:** Clears existing 3d data.
- **Recent 3D files:** Loads previously saved or loaded point clouds.
- **Export 3D data:** Exports the currently visualized point cloud.
- **Print preview:** Shows a print preview of the 3D-View.
- **Print 3D-View:** Prints the 3D-View.
- **Exit:** Closes 3DInspect.

2 - Parameters:

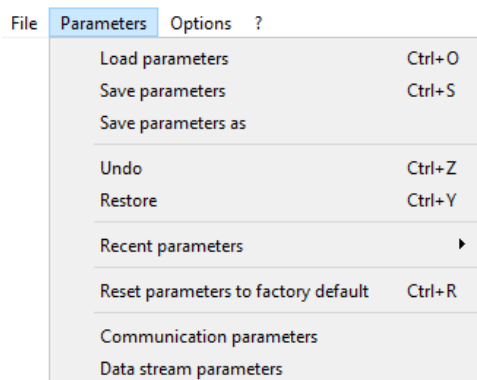

Fig. 3.83: "Parameters" menu

- **Load parameters:** Loads parameters of measuring programs from a file (see Chapter 3.20.2).
- **Save parameters:** Saves the parameters of the active measuring programs to the currently open parameter file (see Chapter 3.20.1).
- **Save parameters as:** Select the folder and name of the file to save the parameter file.
- **Undo:** Undoes the last change (see Chapter 3.21).
- **Restore:** Restores the last change (see Chapter 3.21).
- **Recent parameters:** Loads previously saved or loaded parameters.
- **Reset parameters to factory default:** Resets the parameters to factory default (see Chapter 3.20.3).
- **Communication parameters:** Opens a dialog where you can make advanced settings for the link connection via GigEVision.
- **Data stream parameters:** Opens a dialog where you can make advanced settings for the data transfer via GigEVision.

3 - Options:

Fig. 3.84: "Options" menu

- **Main settings:** Activates a dialog where you can make basic settings (see Chapter 3.25).
- **3D-View Settings:** Activates a dialog where you can configure the settings for the 2D- and 3D-Views (see Chapter 3.12).
- **Ethernet Configurator:** Activates a dialog where you can modify the network settings (IP address, etc.) of the sensors (see Chapter 3.26).
- **Language:** Select the display language:
 - **english [EN]:** English.
 - **deutsch [DE]:** German.

4 - ?:

Fig. 3.85: "?" menu

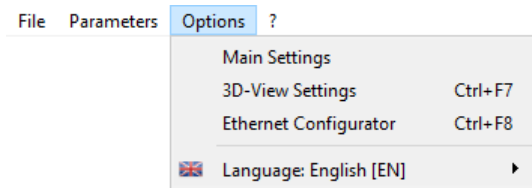
- **About 3DInspect:** Displays an information window about 3DInspect.
- **Online help:** Opens the documentation for the current view.
- **Manual 3DInspect:** Opens the instruction manual of 3DInspect.
- **Shortcuts:** Opens an overview of the available key shortcuts (see Chapter 8.3).
- **Documentation:** Opens an overview where you can call up various help and documentation.
- **Licenses:**
 - **Import license file:** A standard Windows dialog is displayed where you can select a file from which the "Automation" function extension or the network license (necessary for scanCONTROL 30XX) is imported (see also Chapter 1.2). The file name has the extension ".lic" and can contain the licenses for multiple sensors.
 - **Available licenses:** Opens a dialog in which all valid licenses for the "Automation" function extension are displayed.
 - **Ethernet interfaces:** Opens a dialog, which shows the MAC and IP addresses and the names of all available ethernet interfaces and whether a sensor is connected to these interfaces. This information is required to acquire a network license.

Note: Using the function key <F1> or the "?" button in the title bar of each option dialog, you can open the documentation for the current view.

Note: The available elements of the menu bar vary depending on the current evaluation mode (2D/3D, see Chapter 1.4).

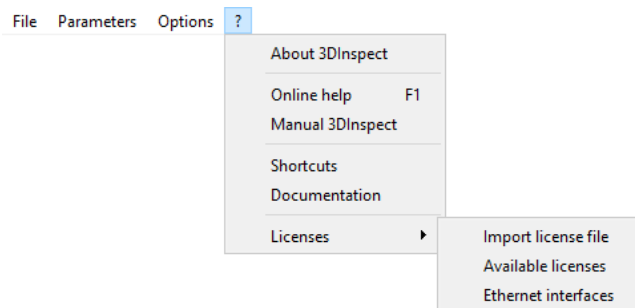
3.24 Functions of the "General" Toolbar











A summary of the functions of the "General" toolbar (see Fig. 3.86 and Fig. 3.87) can be seen in the following.



Fig. 3.86: "General" toolbar (3D Evaluation mode)



Fig. 3.87: "General" toolbar (2D Evaluation mode)

-  Selects a sensor which is connected to the PC as data source (see Chapter 3.4).
-  Selects a file in which a 3D point cloud or a 2D profile sequence has been saved previously as data source (see Chapter 3.5).
-  Saves the 3D point cloud or the 2D profile sequence or the camera images which have been lastly transferred by the connected sensor (see Chapter 3.6.1).
-  Saves the 3D point cloud or the 2D profile sequence or the camera images which have been lastly transferred by the connected sensor (see Chapter 3.6.1).
-  Activates or deactivates the automatic saving of point clouds after each measuring operation (see Chapter 3.6.2 and 3.25, section 4).
-  Loads parameters of measuring programs from a file (see Chapter 3.20.2).
-  Saves the parameters of the active measuring programs to the currently open parameter file (see Chapter 3.20.1).
-  Undoes the last change (see Chapter 3.21).
-  Restores the last change (see Chapter 3.21).
-  Resets the parameters to factory default (see Chapter 3.20.3).
-  Activates a dialog where you can configure the settings for the 2D- and 3D-Views (see Chapter 3.12).

Note: The available elements of the "General" toolbar vary depending on the current evaluation mode (2D/3D, see Chapter 1.4).

3.25 Basic Settings

Select the menu item "Options → Settings" to make basic settings for the software. The "Settings" dialog is displayed (see Fig. 3.88).

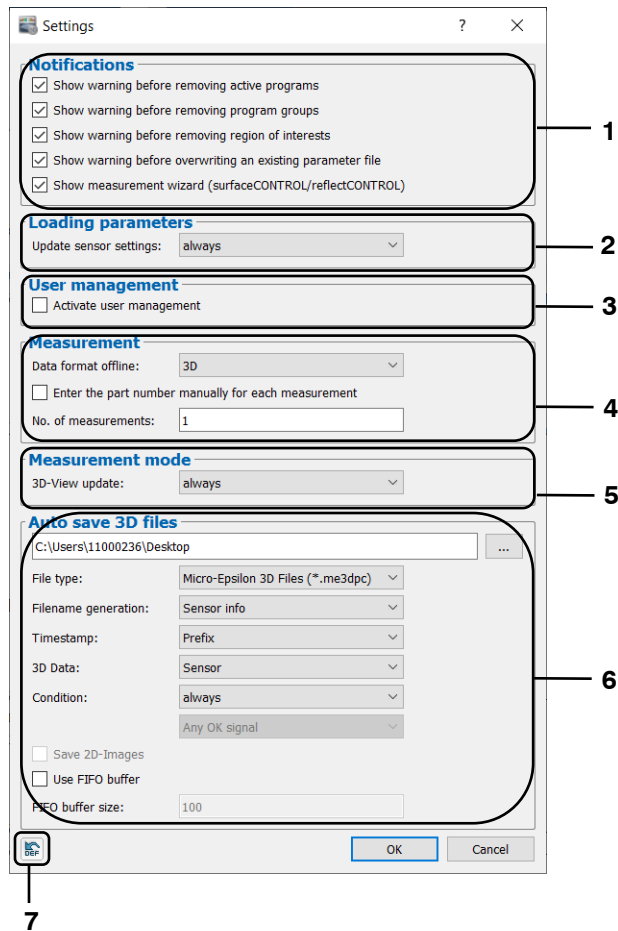

Fig. 3.88: "Settings" dialog box

Parameters in the "Settings" dialog:

- 1
 - **Show warning before removing active programs:** Shows a warning before removing a program from the active program list (see Chapter 3.15).
 - **Show warning before removing program groups:** Shows a warning before removing program groups (see Chapter 3.17).
 - **Show warning before removing region of interests:** Shows a warning before removing region of interests (see Chapter 3.18.7).
 - **Show warning before overwriting an existing parameter file:** Shows a warning before overwriting an existing parameter file (see Chapter 3.20.1).
 - **Show measurement wizard (surfaceCONTROL/reflectCONTROL):** Starts a measurement wizard when connecting to a surfaceCONTROL/reflectCONTROL sensor (see Chapter 3.4.8).
- 2
 - **Update sensor settings:** You configure the behavior of the sensor parameters when loading parameter files.
 - **always:** The sensor parameters stored in the parameter file will be adopted and written to the connected sensor.
 - **never:** The sensor parameters stored in the parameter file will be ignored and not adopted.
 - **ask:** When loading a parameter file, you can select whether the sensor parameters stored in the parameter file will be adopted.
- 3
 - **Activate user management:** You may activate or deactivate the user management in 3DInspect. If you activate the user management and close this dialog, an info window is shown with the factory default login information for the manager (see Chapter 3.22).

- 4
- **Data format offline:** Use this parameter for selecting the data format and the corresponding evaluation mode which will be used of 3DInspect in offline mode (see Chapter 1.4 and 3.5):
 - **2D:** 3DInspect processes 2D data.
 - **3D:** 3DInspect processes 2D data.
 - **Enter the part number manually for each measurement:** When you activate this parameter, a dialog for entering the part number will be shown for each measuring operation. The part number may be logged in the protocol file (see Chapter 7.4) or may be used for the automatic saving of point clouds (see below, Section 4 and Chapter 3.6.2), for example. When this parameter is not active, the part number may be passed using the automation interface (see Chapter 7.4)
 - **No. of measurements:** Defines the number of measuring operations which are processed when pressing the "Start measurement button" (see Chapter 3.2, Section 5) in setup mode.
- 5
- **3D-View update:** Set the behavior of the 3D-View in measurement mode here:
 - **Always:** The measured point cloud is always shown after each measurement.
 - **nOK:** The measured point cloud is shown when at least one assessed measured value is deemed nOK.
 - **Never:** The measured point cloud is never shown.
- 6
- **Directory selection:** Select a folder where point clouds will be saved automatically if the corresponding option is active (see Chapter 3.6.2).
 - **File type:** Selection of the file type for the automatically saved point cloud (see Chapter 3.6.2).
 - **Filename generation:** This parameter defines how the filename will be generated for automatic saved point clouds:
 - **Sensor info:** [Model name]-[Serial number].
 - **Part number:** [Part number] (see above, Section 3 and Chapter 7.4).
 - **Output signal:** [Measurement value] (Select with the signal index, which measurement value will be used for generating the file name. The signal index references the selected signals in the "Measurement control / Measured values output" dialog, Section 3 and Chapter 7.4).
 - **Timestamp:** Use this parameter to select if and where the timestamp [Date] [Time] is added to the file name (see above):
 - **Prefix:** The timestamp is prepended to the filename.
 - **Append:** The timestamp is appended to the filename.
 - **None:** No timestamp is used in the file name.
 - **3D Data:** Select which data will be saved when automatic saving is active:
 - **Sensor:** Saves the point cloud which has been transferred by the connected sensor.
 - **"Outputs and results" view:** The point cloud which has been selected in the "Outputs and results" view (see Chapter 7, Section 1) will be saved
 - **Condition:** Use this parameter to define the condition for the automatic saving of point clouds, which is derived from the assessed measured values (see Chapter 7.3):
 - **Always:** All measured point clouds are saved.
 - **nOK:**
 - **All nOK signals:** The point cloud is saved when all assessed measured values are deemed nOK.
 - **Any nOK signal:** The measured point cloud is saved when at least one assessed measured value is deemed nOK.
 - **nOK x:** The measured point cloud is saved when the assessed measured value x is deemed nOK.
 - **OK:**
 - **All OK signals:** The measured point cloud is saved when all assessed measured values are deemed OK.
 - **Any OK signal:** The measured point cloud is saved, when at least one assessed measured value is deemed OK.
 - **OK x:** The measured point cloud is saved, when the assessed measured value x is deemed OK.
 - **Save 2D-Images:** If this parameter is active and the "3D + 2D-Images" data format is used (see Chapter 3.4.1 and 3.4.3), 2D-Images will be saved (surfaceCONTROL/reflectCONTROL).
 - **Use FIFO buffer:** If this parameter is active, a maximum number for saving point clouds automatically can be defined. The oldest files in the given folder (see above) will be deleted when the maximum number is exceeded.
 - **FIFO buffer size:** Defines the maximum number for saving point clouds automatically.

- 7 Reset to factory default:** Use this button in order to reset all parameters of this dialog to factory default.

Note: The settings in this dialog are effective globally and are not included when loading or saving parameters.

3.26 Adjusting Sensor Network Settings (Ethernet Configurator)

When using a Micro-Epsilon 3D sensor with an Ethernet interface you may adjust the system network settings (IP address, etc.) by selecting the "Options → Ethernet Configurator" menu item. The "Ethernet Configurator" dialog will be opened.

Note: To be able to operate a sensor via Ethernet with 3DInspect, the sensor and your PC must be located in the same subnet. Adjust any relevant network settings for the sensor in the "Ethernet Configurator" dialog.

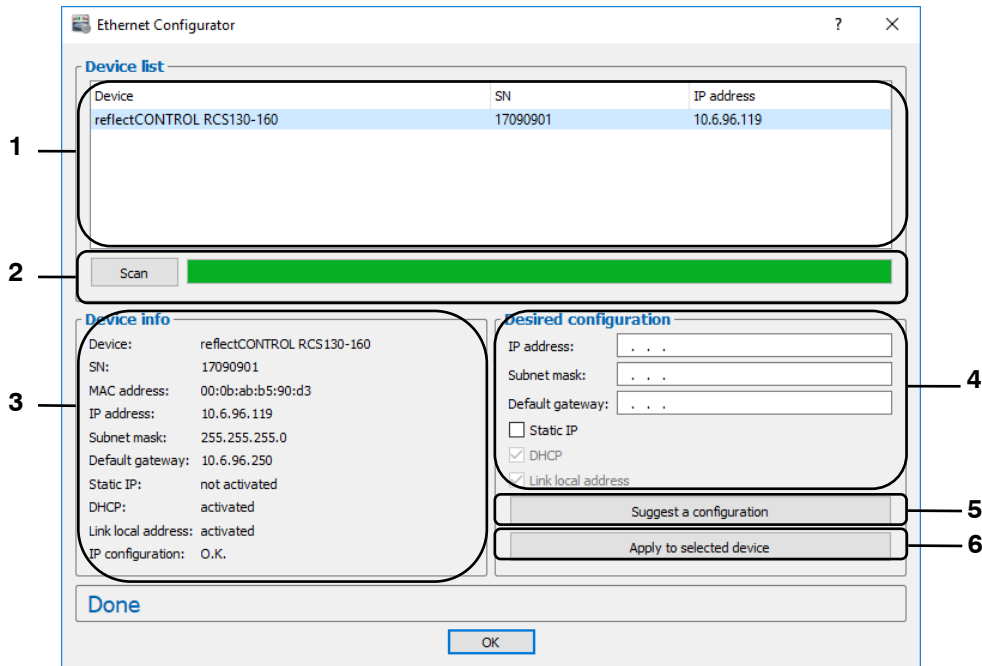

Fig. 3.89: "Ethernet Configurator" dialog box

Display elements and parameters in the "Ethernet Configurator" dialog:

- 1 **Device list:** This section lists all available sensors. Click "Scan" to refresh the list. Select the desired sensor.
- 2 **Scan:** Click this button to search for sensors in all subnets connected to the PC. The scan progress is displayed. When the scanning is complete, any found sensors are displayed in the list.
- 3 **Device info:** Displays the current settings for the selected sensor:
 - **Device:** Device name
 - **SN:** Serial number
 - **MAC address:** Physical address
 - **IP address:** IP address
 - **Subnet mask:** Subnet mask
 - **Default gateway:** Default gateway
 - **Static IP:** "Static IP" address option enabled
 - **DHCP:** "DHCP" option enabled
 - **Link local address:** "Link local address" option enabled
 - **IP configuration:** Indicates whether the network configuration is valid. If the network configuration is not valid, the sensor cannot be used with 3DInspect.

- 4 **Desired configuration:** Use the following input fields to enter the network configuration for the selected sensor:
 - **IP address:** IP address
 - **Subnet mask:** Subnet mask
 - **Default gateway:** Default gateway
 - **Static IP:** "Static IP" option – if this option is enabled, dynamic address allocation is disabled. The IP address entered is used as IP address. This parameter takes precedence over the "DHCP" and "Link local address" options.
 - **DHCP:** "DHCP" option – if this option is enabled, the IP address is allocated dynamically through a DHCP server. This parameter takes precedence over "Link local address". This option is always enabled.
 - **Link local address:** "Link local address" option – if this option is enabled, the IP address is allocated dynamically in the local subnet 169.254.x.x. This option is always enabled.
- 5 **Suggest a configuration:** Click this button to have a suitable configuration for the selected sensor determined automatically. After the process is complete, the system automatically completes the input fields in the "Desired configuration" section.
- 6 **Apply to selected device:** Click this button to apply the network configuration specified in the "Desired configuration" section to the selected sensor.

Proceed as follows to manually enter the network configuration parameters for a sensor:

- ➡ When the "Ethernet Configurator" dialog is opened, the system automatically searches for available sensors. If the sensor is not connected to your subnet yet, establish a connection, and click the "Scan" button. When scanning is complete, the sensor is displayed in the device list.
- ➡ Select the required sensor from the device list.
- ➡ Specify the required network settings in the input fields in the "Desired configuration" section.
- ➡ Click "Apply to selected device" to apply the settings to the selected sensor.
- ➡ Click OK to confirm the selections in the "Ethernet Configurator" dialog.

Proceed as follows to automatically specify network configuration parameters for a sensor:

- ➡ When the "Ethernet Configurator" dialog is opened, the system automatically searches for available sensors. If the sensor is not connected to your subnet yet, establish a connection, and click the "Scan" button. When scanning is complete, the sensor is displayed in the device list.
- ➡ Select the required sensor from the device list.
- ➡ Click the "Suggest a configuration" button to have a suitable network configuration for the selected sensor determined automatically. After the process is complete, the system automatically completes the input fields in the "Desired configuration" section.
- ➡ Click "Apply to selected device" to apply the settings to the selected sensor.
- ➡ Click OK to confirm the selections in the "Ethernet Configurator" dialog.

3.27 Exiting 3DInspect

Select the "File → Exit" menu item or press the standard Windows button  in the title bar of the program window in order to exit 3DInspect.

4. Description of the "Data Acquisition" View

In the "Data acquisition" view, you can set the parameters for the sensor in order to ensure optimal measurement data acquisition. In this view, you can switch between two or three subviews depending on the type of sensor:

- **"Display Image Data" Tab:**
 - **reflectCONTROL/surfaceCONTROL:** The "Display Image Data" view shows the original images of both cameras in the sensor as well as their frequency distribution (histogram) (see Chapter 4.1.1).
 - **scanCONTROL 30XX:** The "Display Image Data" view shows the original signal recorded on the sensor matrix of scanCONTROL (see Chapter 4.1.2).
 - **ProfileUnit:** The "Display Image Data" view shows the original signals recorded on the sensor matrix of the sensors connected to the „ProfileUnit“ measurement system (see Chapter 4.1.3).
- **"2D-Images" Tab:** The "2D-Images" view shows result images of the 2D measurement (see Chapter 4.2).
- **"Sensor Configuration" Tab (ProfileUnit):** In the "Sensor configuration" view, the individual scanCONTROL sensors connected to the „ProfileUnit“ measurement system can be parameterized. In addition, the registration of the sensors to each other can be carried out in this view (see Chapter 4.3).
- **"3D-View" Tab:** The "3D-View" view visualizes the last measured point cloud of the sensor (see Chapter 4.4).
- **"2D-View" Tab (ProfileUnit):** The "2D-View" view visualizes the last measured profile of the ProfileUnit system (see Chapter 4.5).

4.1 Description of the "Display Image Data" Tab

4.1.1 Description of the "Display Image Data" Tab (surfaceCONTROL/reflectCONTROL)

The "Display Image Data" view shows the raw image of each camera in the sensor and the corresponding histogram. The images are transferred continuously from the sensor. This view is useful for detecting and eliminating sources of errors and interference, such as overexposure.

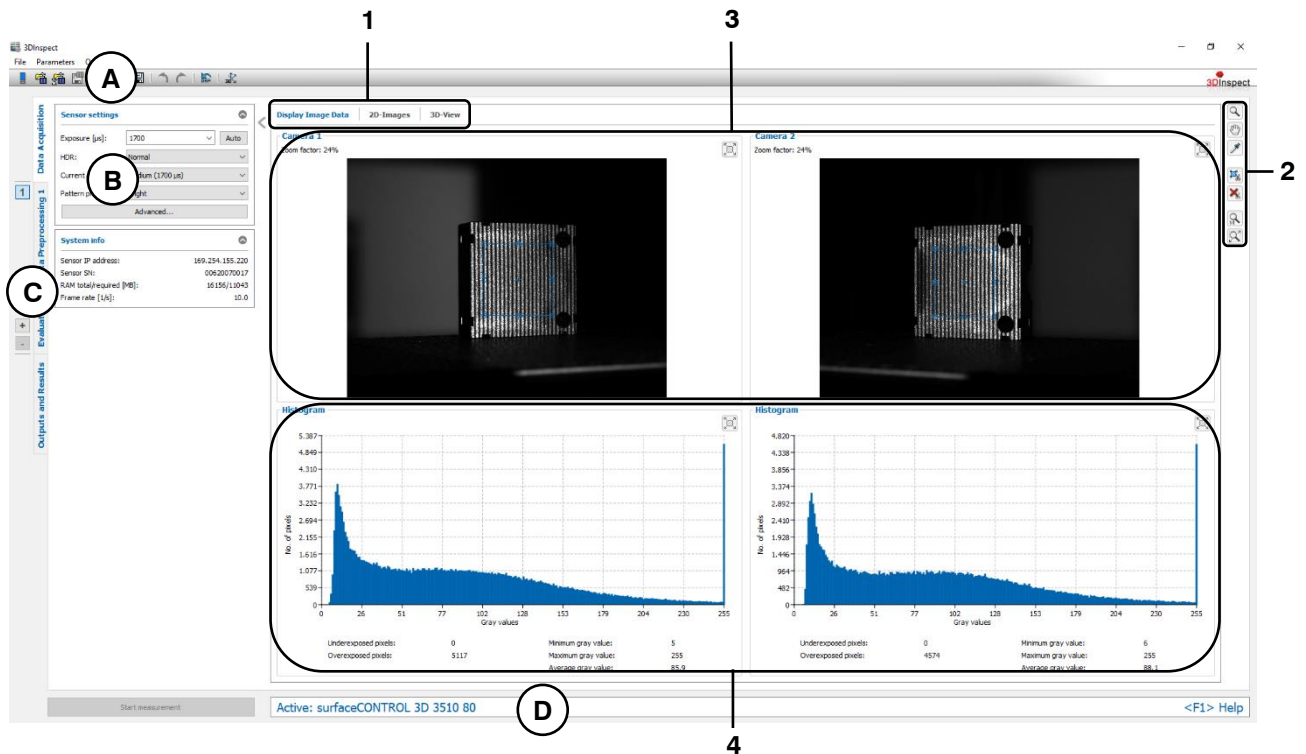









Fig. 4.1: "Display Image Data" view (surfaceCONTROL/reflectCONTROL)

Display elements and parameters in the "Display Image Data" view:



- A** **"General" toolbar:** Using this toolbar, you can select the data source (see Chapter 3.4 and 3.5), save and load parameters (see Chapter 3.20), reset selected parameters to default settings (see Chapter 3.20.3) and undo and restore changes of settings and parameters (see Chapter 3.21).
- B** **Sensor settings:** Change the settings of the sensor with these values. Detail information about each parameter can be found in Chapters 3.4.1 and 3.4.3.
- C** **Tab bar for switching between views:** This tab bar allows you to switch between the four main views (see Chapter 3.2).
- D** **Status line:** Status and error messages are displayed on the status line (see Chapter 8.1).
- 1** **Tab bar for switching between subviews:** This tab bar allows you to switch between the subviews of the "Data acquisition" view (see Chapter 4).
- 2** **"Display" / "Measurement" toolbar:** Using this toolbar, you scale the 2D-display and activate various options for mouse interaction:
 -  Activates or deactivates the "Zoom" mode. In this mode you can zoom in parts of the camera image and so directly set the scaling of the image with your mouse.
 -  Activates or deactivates the "Move image" mode. In this mode you can move the image.
 -  Activates the "Show pixel information" mode. In this mode the gray values of an individual pixel is shown. To do so, move the mouse pointer to the desired pixel and press the left mouse button.

-  Activates the "Set region of interest" mode. In this mode you may define a rectangular range for each camera. Pixels which are inside the range will be used for computing the 3D point cloud. Pixels which are outside the range will be discarded. In order to set a range, move the mouse pointer to the desired position, press the left mouse button and keep it pressed to draw out a range.
-  Activates the "Set region of interest for histogram" mode. In this mode you may define a rectangular range for each camera. Pixels which are inside the range will be used for histogram analysis. In order to set a range, move the mouse pointer to the desired position, press the left mouse button and keep it pressed to draw out a range. This setting has no influence on the computation of the measurement results.
-  Resets the region of interests respectively the region of interests for histogram. All pixels of the raw images will be used for computing the 3D point cloud respectively all pixels are used for histogram analysis.
-  Scales the displays so that the complete camera images will be shown.
-  Scales the displays to the original image size.

Note: The "Set region of interest" mode is only available when using a reflectCONTROL sensor.

Note: Changes of the region of interests and of the region of interests for histogram will be applied automatically to the "2D-Images" view (see Chapter 4.1.3).

- 3 Raw images:** The currently captured camera images are shown. The displays are updated continuously.
- 4 Histograms:** The frequency distribution of the gray values from 0 to 255 in the region of interest  of the corresponding camera image is shown. The displays are updated continuously. Below, the following information is shown:
- **Underexposed pixels:** The number of pixels whose gray value is smaller than three.
 - **Overexposed pixels:** The number of pixels whose gray value is 255.
 - **Min. gray value:** The minimum gray value of the corresponding raw image.
 - **Max. gray value:** The maximum gray value of the corresponding raw image.
 - **Average gray value:** The average gray value of the corresponding raw image.

Note: Use the Buttons  and  respectively in order to maximize and minimize respectively the corresponding display (raw image / histogram).

4.1.2 Description of the "Display Image Data" Tab (scanCONTROL 30XX)

The "Display Image Data" view shows the original signal recorded on the sensor matrix of scanCONTROL. This view is useful for detecting and eliminating sources of errors and interference, such as over-exposure or multiple reflections.

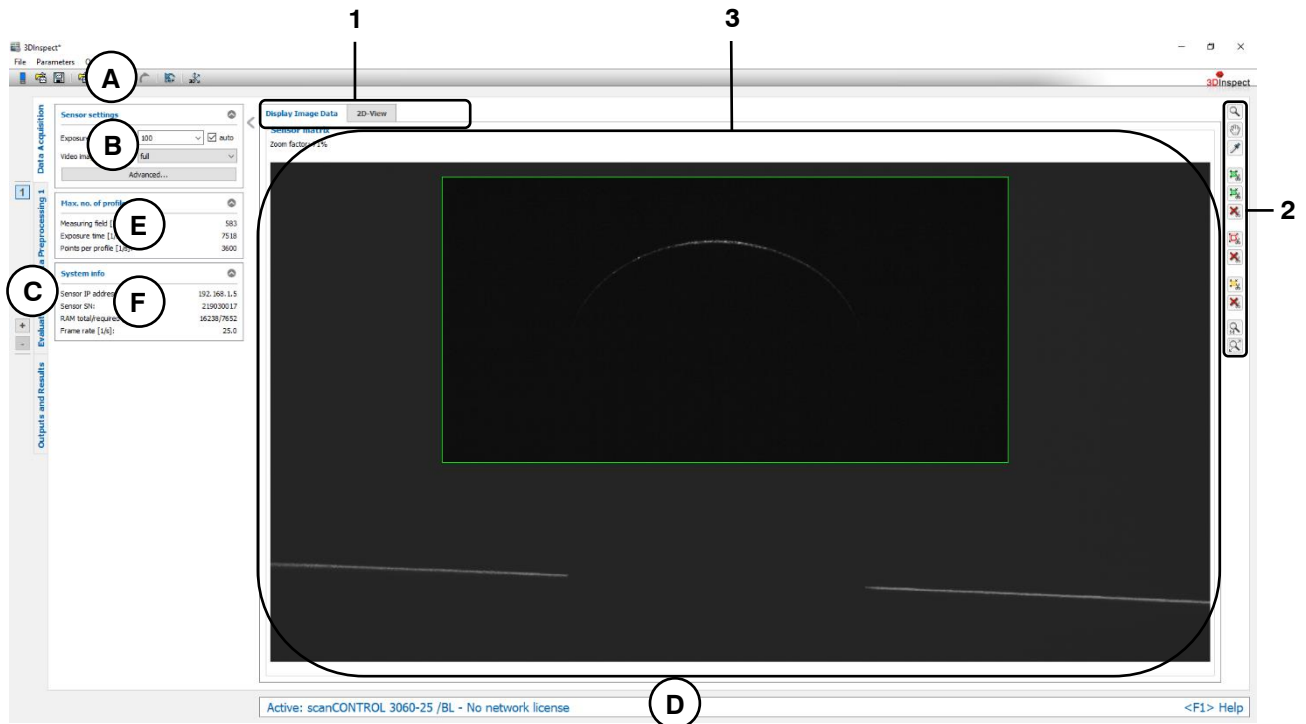



Fig. 4.2: "Display Image Data" view (scanCONTROL)

Display elements and parameters in the "Display Image Data" view:

- A** **"General" toolbar:** Using this toolbar, you can select the data source (see Chapter 3.4 and 3.5), save and load parameters (see Chapter 3.20), reset selected parameters to default settings (see Chapter 3.20.3) and undo and restore changes of settings and parameters (see Chapter 3.21).
 - B** **Sensor settings:** Change the settings of the sensor with these values. Detail information about each parameter can be found in Chapter 3.4.4.
 - C** **Tab bar for switching between views:** This tab bar allows you to switch between the four main views (see Chapter 3.2).
 - D** **Status line:** Status and error messages are displayed on the status line (see Chapter 8.1).
 - E** **Max. no. of profiles:**
 - **Measuring field [1/s]:** The maximum profile frequency resulting from the setting of the "Measuring field" parameter.
 - **Exposure time [1/s]:** The maximum profile frequency resulting from the setting of the "Exposure" parameter.
 - **Points per profile [1/s]:** The maximum profile frequency resulting from the setting of the "Points per profile" parameter.
 - F** **Status display:** The status display shows current sensor information (see Chapter 3.7).
- 1** **Tab bar for switching between subviews:** This tab bar allows you to switch between the subviews of the "Data acquisition" view (see Chapter 4).
- 2** **"Display" / "Measurement" toolbar:** Using this toolbar, you scale the video image and activate various options for mouse interaction:
-  Activates or deactivates the "Zoom" mode. In this mode you can zoom in parts of the video image and so directly set the scaling of the image with your mouse.



Activates or deactivates the "Move image" mode. In this mode you can move the image.



Activates the "Show pixel information" mode. In this mode the gray values of an individual pixel is shown. To do so, move the mouse pointer to the desired pixel and press the left mouse button.



Activates the "Set measuring field" mode. In this mode you may define two rectangular ranges. Pixels which are inside the ranges will be used for computing the 3D point cloud. Pixels which are outside the ranges will be discarded. In order to set the ranges, move the mouse pointer to the desired position, press the left mouse button and keep it pressed to draw out a range.



Activates the "Set region of no interest" mode. In this mode you may define a rectangular range. Pixels which are outside the range will be used for computing the 3D point cloud. Pixels which are inside the range will be discarded. In order to set the range, move the mouse pointer to the desired position, press the left mouse button and keep it pressed to draw out a range.



Activates the "Set reference field for auto exposure" mode. In this mode you may define a rectangular range. Pixels which are inside the range will be used for automatic exposure time control. In order to set the range, move the mouse pointer to the desired position, press the left mouse button and keep it pressed to draw out a range.



Resets the corresponding measuring and reference fields.



Scales the displays so that the complete camera images will be shown.



Scales the displays to the original image size.

- 3 Video image:** This display shows the just recorded image of the sensor matrix. The measuring and reference fields are shown on the display as a red rectangle.

4.1.3 Description of the "Display Image Data" Tab (ProfileUnit)

The "Display Image Data" view shows the original signals recorded on the sensor matrix of the sensors connected to the „ProfileUnit“ measurement system. This view is useful for detecting and eliminating sources of errors and interference, such as overexposure or multiple reflections.

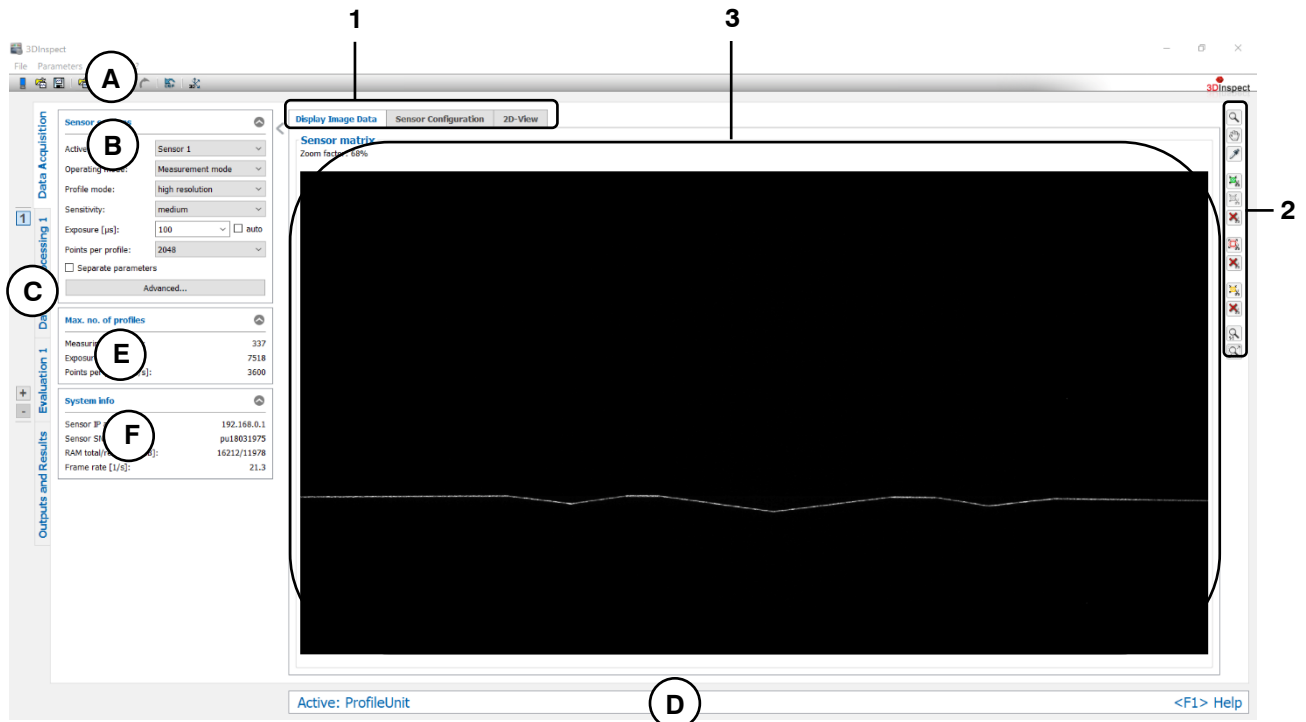











Fig. 4.3: "Display Image Data" view (ProfileUnit)

Display elements and parameters in the "Display Image Data" view (ProfileUnit):

- A** **"General" toolbar:** Using this toolbar, you can select the data source (see Chapter 3.4 and 3.5), save and load parameters (see Chapter 3.20), reset selected parameters to default settings (see Chapter 3.20.3) and undo and restore changes of settings and parameters (see Chapter 3.21).
- B** **Sensor settings:** Select one of the scanCONTROL sensors connected to the ProfileUnit and change the settings of the selected sensor. Detail information about each parameter can be found in Chapter 3.4.5.
- C** **Tab bar for switching between views:** This tab bar allows you to switch between the four main views (see Chapter 3.2).
- D** **Status line:** Status and error messages are displayed on the status line (see Chapter 8.1).
- E** **Max. no. of profiles:**
 - **Measuring field [1/s]:** The maximum profile frequency resulting from the setting of the "Measuring field" parameter.
 - **Exposure time [1/s]:** The maximum profile frequency resulting from the setting of the "Exposure" parameter.
 - **Points per profile [1/s]:** The maximum profile frequency resulting from the setting of the "Points per profile" parameter.
- F** **Status display:** The status display shows current sensor information (see Chapter 3.7).
- 1** **Tab bar for switching between subviews:** This tab bar allows you to switch between the subviews of the "Data acquisition" view (see Chapter 4).
- 2** **"Display" / "Measurement" toolbar:** Using this toolbar, you scale the video image and activate various options for mouse interaction:

-  Activates or deactivates the "Zoom" mode. In this mode you can zoom in parts of the video image and so directly set the scaling of the image with your mouse.
-  Activates or deactivates the "Move image" mode. In this mode you can move the image.
-  Activates the "Show pixel information" mode. In this mode the gray values of an individual pixel is shown. To do so, move the mouse pointer to the desired pixel and press the left mouse button.
-  Activates the "Set measuring field" mode. In this mode you may define two rectangular ranges. Pixels which are inside the ranges will be used for computing the 3D point cloud. Pixels which are outside the ranges will be discarded. In order to set the ranges, move the mouse pointer to the desired position, press the left mouse button and keep it pressed to draw out a range.
-  Activates the "Set region of no interest" mode. In this mode you may define a rectangular range. Pixels which are outside the range will be used for computing the 3D point cloud. Pixels which are inside the range will be discarded. In order to set the range, move the mouse pointer to the desired position, press the left mouse button and keep it pressed to draw out a range.
-  Activates the "Set reference field for auto exposure" mode. In this mode you may define a rectangular range. Pixels which are inside the range will be used for automatic exposure time control. In order to set the range, move the mouse pointer to the desired position, press the left mouse button and keep it pressed to draw out a range.
-  Resets the corresponding measuring and reference fields.
-  Scales the displays so that the complete camera images will be shown.
-  Scales the displays to the original image size.

3 Video image: This display shows the just recorded image of the sensor matrix of the selected sensor (see section "B"). The measuring and reference fields are shown on the display as rectangles.

4.2 Description of the "2D-Images" Tab

The "2D-Images" view shows result images of the 2D measurement. You may execute a measurement by pressing the "Start measurement" button.

Note: The "2D-Images" tab is only available if using a reflectCONTROL or a surfaceCONTROL sensor and if the "3D + 2D-Images" data format is selected (see Chapter 3.4.1 and 3.4.3).

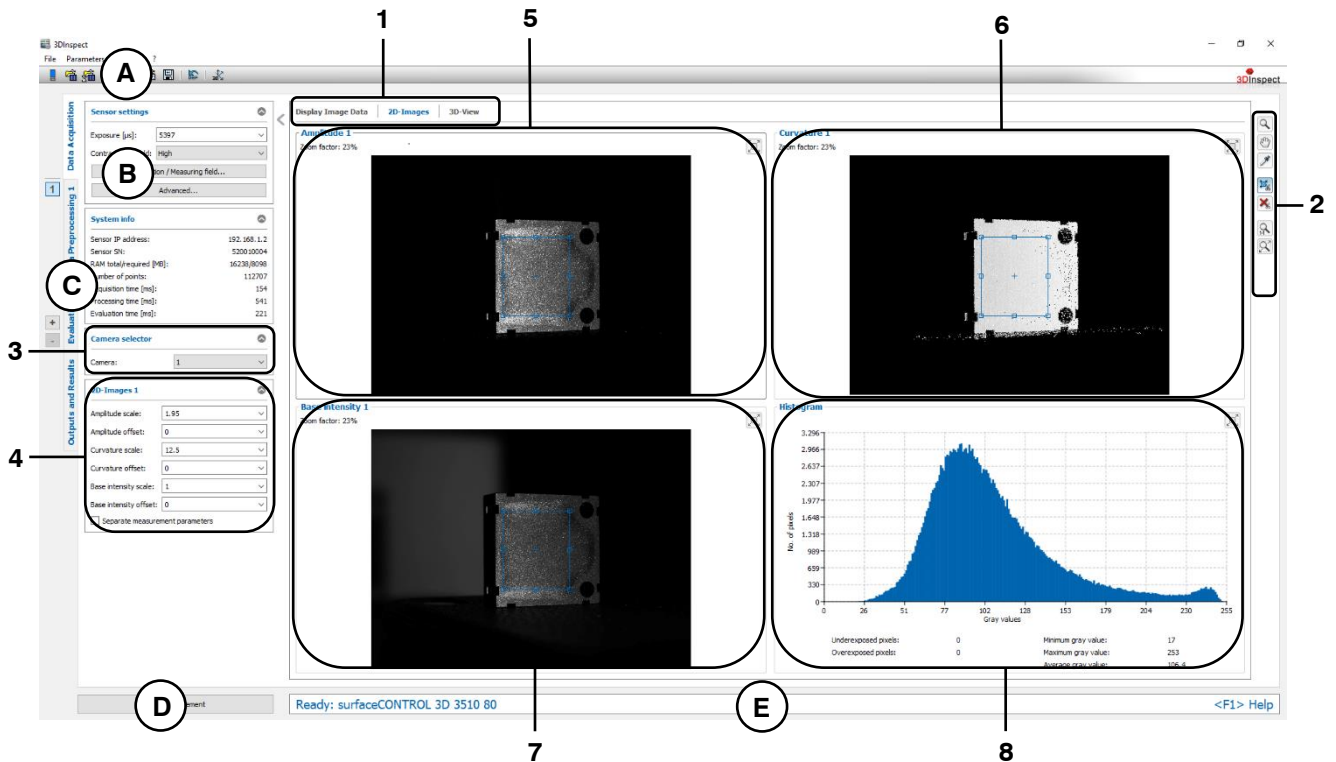





Fig. 4.4: "2D-Images" view

Display elements and parameters in the "2D-Images" view:

- A "General" toolbar:** Using this toolbar, you can select the data source (see Chapter 3.4 and 3.5), save and load parameters (see Chapter 3.20), reset selected parameters to default settings (see Chapter 3.20.3) and undo and restore changes of settings and parameters (see Chapter 3.21).
 - B Sensor settings:** Change the settings of the sensor with these values. Detail information about each parameter can be found in Chapters 3.4.1 and 3.4.3.
 - C Tab bar for switching between views:** This tab bar allows you to switch between the four main views (see Chapter 3.2).
 - D "Start measurement" button:** Click on this button to perform a measuring operation, calculate the measurement results and display the result images of the 2D measurement.
 - E Status line:** Status and error messages are displayed on the status line (see Chapter 8.1).
- 1 Tab bar for switching between subviews:** This tab bar allows you to switch between the subviews of the "Data acquisition" view (see Chapter 4).
 - 2 "Display" / "Measurement" toolbar:** Using this toolbar, you scale the 2D-display and activate various options for mouse interaction (see Chapter 4.1, Section 2).
 - 3 Camera selector:** Select whether the result images of camera 1 or camera 2 are shown.
 - 4 2D-Images x:** The following parameters for the 2D measurement are available:
 - **Amplitude scale:** The scaling factor for the gray values in the amplitude image.
 - **Amplitude offset:** The offset for the gray values in the amplitude image.

- **Curvature/Gradient scale:** The scaling factor for the gray values in the curvature or gradient image.
 - **Curvature/Gradient offset:** The offset for the gray values in the curvature or gradient image.
 - **Base intensity scale:** The scaling factor for the gray values in the base intensity image.
 - **Base intensity offset:** The offset for the gray values in the base intensity image.
 - **Separate measurement parameters:** If this parameter is active, you may use different values for the respective cameras.
- 5 **Amplitude x:** This display visualizes the last measured amplitude image of the selected camera.
- 6 **Curvature x / Gradient x:** This display visualizes the last measured curvature or gradient image of the selected camera.
- 7 **Base intensity x:** This display visualizes the last measured base intensity image of the selected camera.
- 8 **Histograms:** The frequency distribution of the gray values from 0 to 255 in the region of interest  of the selected measurement image is shown. The selected region of interest matches with the corresponding region of interest in the "Display image data" view. In order to display the distribution of a certain image, click with the mouse pointer into the amplitude, curvature or base intensity image. Below, the following information is shown:
- **Underexposed pixels:** The number of pixels whose gray value is smaller than three.
 - **Overexposed pixels:** The number of pixels whose gray value is 255.
 - **Min. gray value:** The minimum gray value of the corresponding raw image.
 - **Max. gray value:** The maximum gray value of the corresponding raw image.
 - **Average gray value:** The average gray value of the corresponding raw image.

Note: Use the Buttons  and  respectively in order to maximize and minimize respectively the corresponding display (raw image / histogram).

4.3 Description of the "Sensor Configuration" Tab (ProfileUnit)

In the "Sensor configuration" view, the individual scanCONTROL sensors connected to the „ProfileUnit“ measurement system can be parameterized. In addition, the registration of the sensors to each other can be carried out in this view.

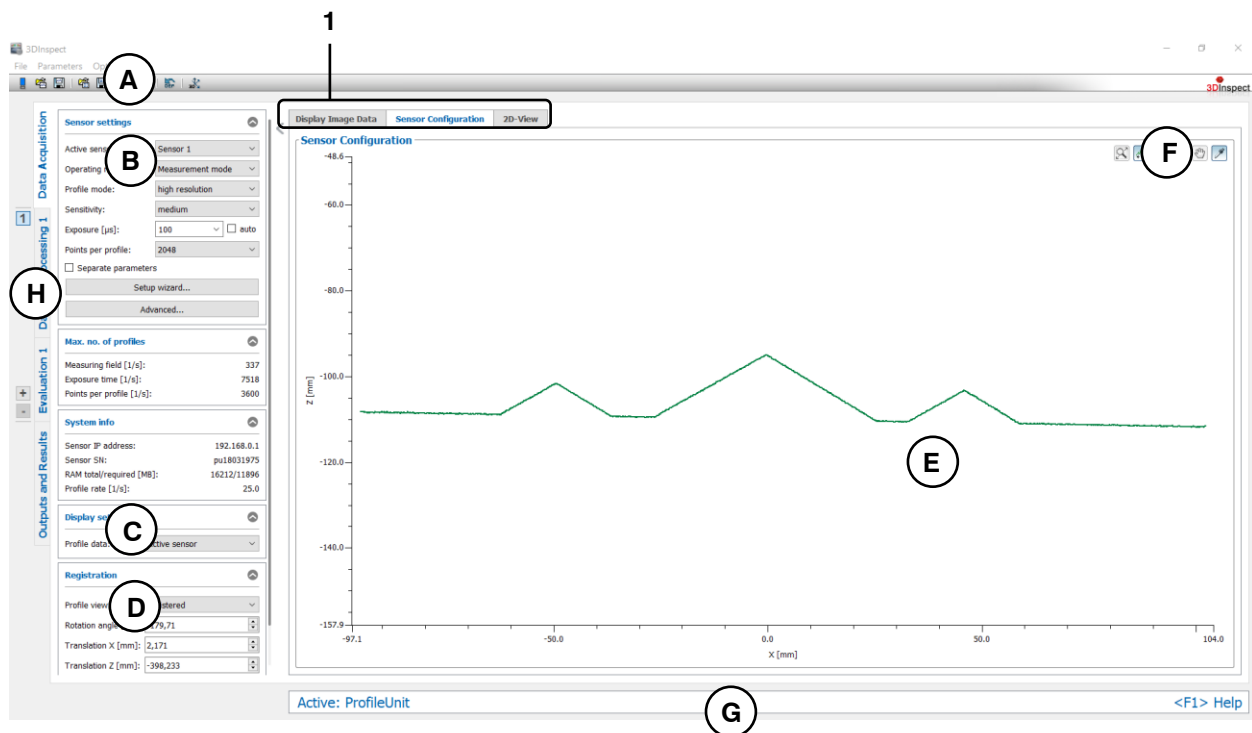

Fig. 4.5: "Sensor Configuration" tab (ProfileUnit)

Display elements and parameters in the "Sensor Configuration" tab (ProfileUnit):

- A "General" toolbar:** Using this toolbar, you can select the data source (see Chapter 3.4 and 3.5), save and load parameters (see Chapter 3.20), reset selected parameters to default settings (see Chapter 3.20.3) and undo and restore changes of settings and parameters (see Chapter 3.21).
- B Sensor settings:** Select one of the scanCONTROL sensors connected to the ProfileUnit and change the settings of the selected sensor. Detail information about each parameter can be found in Chapter 3.4.5.
- C Display settings:** With this selection you determine from which scanCONTROL sensor the profile is displayed in the 2D-View.
- D Registration:** In this area, make settings for registering the sensors connected to ProfileUnit with each other. You can make the settings manually or automatically:
 - **Make settings manually for each individual sensor:** For the currently selected sensor (See section "B"), make the following settings:
 - **Profile view:** Select whether the transformation made should be taken into account for the profile shown in the 2D-display.
 - **Rotation angle [°]:** The angle by which the profile of the active sensor is rotated. The origin of the coordinate system is used as the center of rotation.
 - **Translation X [mm]:** The offset by which the profile of the active sensor is shifted in the X direction.
 - **Translation Z [mm]:** The offset by which the profile of the active sensor is shifted in the Z direction.
 - **Flip profile:** If necessary, the profile can be inverted. This is necessary if the active sensor is rotated 180° around the Z-axis compared to the other sensors.

- **Execute automatic registration...:** Execute the automatic registration of the sensors to each other. To do this, position the corresponding registration object in the measuring field of the sensors connected to ProfileUnit and press the "Execute automatic registration..." button. A dialog appears in which you can enter or select the path and name of the referencing file corresponding to the registration object. The file name has the ".json" extension. After confirming the dialog, the registration of all sensors will be executed automatically.
- E** **2D-View:** The 2D-View visualizes the last measured point cloud of the sensor (see Chapter 3.13).
- F** **"2D Profile View" toolbar:** Use this toolbar to scale the 2D Profile View and activate various options for mouse interaction (see Chapter 3.13).
- G** **Status line:** Status and error messages are displayed on the status line (see Chapter 8.1).
- H** **Tab bar for switching between views:** This tab bar allows you to switch between the four main views (see Chapter 3.2).

- 1** **Tab bar for switching between subviews:** This tab bar allows you to switch between the subviews of the "Data acquisition" view (see Chapter 4).

4.4 Description of the "3D-View" Tab

The last transferred point cloud of the connected sensor is visualized in the "3D-View" tab.

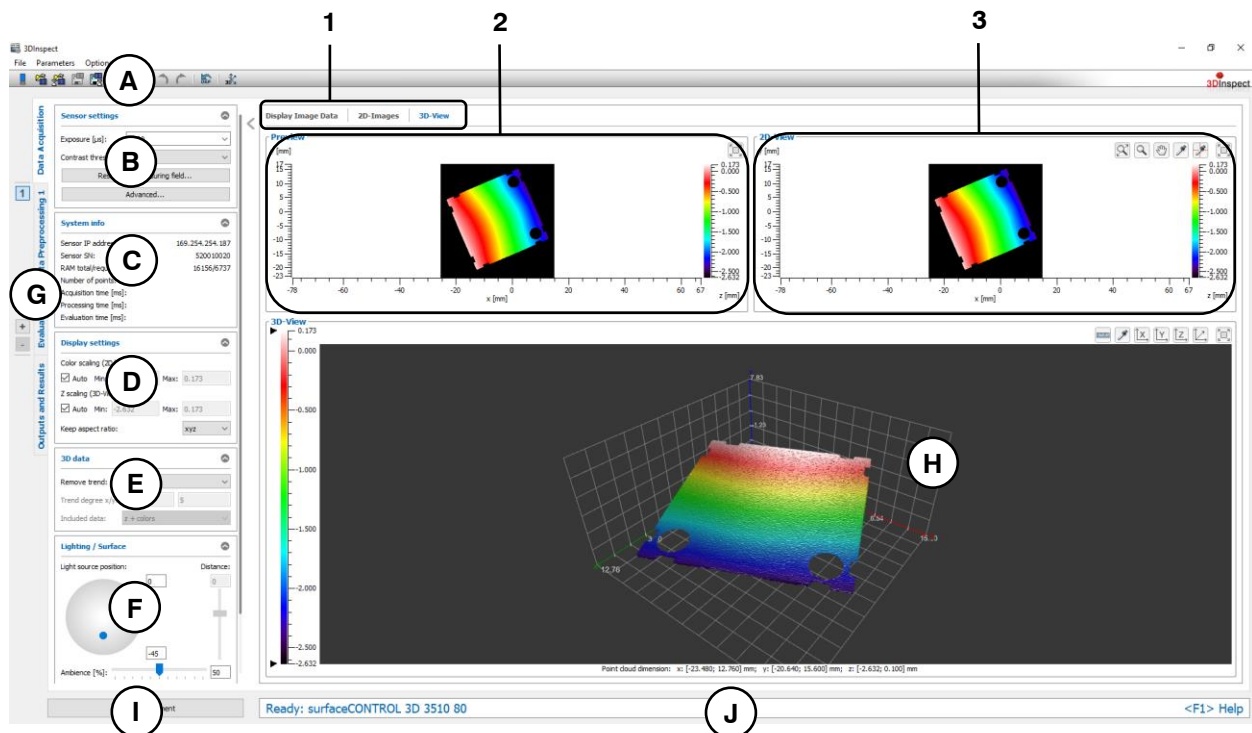

Fig. 4.6: "3D-View" tab

Display elements and parameters in the "3D-View" tab:

- A** **"General" toolbar:** Using this toolbar, you can select the data source (see Chapter 3.4 and 3.5), save and load parameters (see Chapter 3.20), reset selected parameters to default settings (see Chapter 3.20.3) and undo and restore changes of settings and parameters (see Chapter 3.21).
 - B** **Sensor settings:** Change the settings of the sensor with these values. Detail information about each parameter can be found in Chapters 3.4.1 and 3.4.3.
 - C** **Status display:** The status display shows current sensor information and the last measurement that was carried out (see Chapter 3.7).
 - D** **Display settings:** Use this section to specify settings for the 2D- and 3D-View (see Chapter 3.8).
 - E** **3D data:** Use these parameters for removing a trend of the 3D data (see Chapter 3.9).
 - F** **Lighting/Surface:** Use this input field to set the lighting and surface properties of the 3D data (see Chapter 3.10).
 - G** **Tab bar for switching between views:** This tab bar allows you to switch between the four main views (see Chapter 3.2).
 - H** **3D-View:** The 3D-View visualizes the last measured point cloud of the sensor (see Chapter 3.11)
 - I** **"Start measurement" button:** Click on this button to perform a measuring operation, calculate the measurement results and display the point cloud in the 3D-View.
 - J** **Status line:** Status and error messages are displayed on the status line (see Chapter 8.1).
- 1** **Tab bar for switching between subviews:** This tab bar allows you to switch between the subviews of the "Data acquisition" view (see Chapter 4).
 - 2** **Preview:** The preview visualizes the last measured point cloud of the sensor as a 2½-D image (see Chapter 4.4.1).

- 3 2D-View:** The 2D-View visualizes the last measured point cloud of the sensor as a 2½-D image. You have various options for interacting with the image (see Chapter 4.4.2).

4.4.1 Description of the Preview Window

The preview window visualizes the last measured point cloud of the sensor as a 2½-D image. The preview window is updated after executing a measurement. The colored texture of the display represents the height values of the individual points.

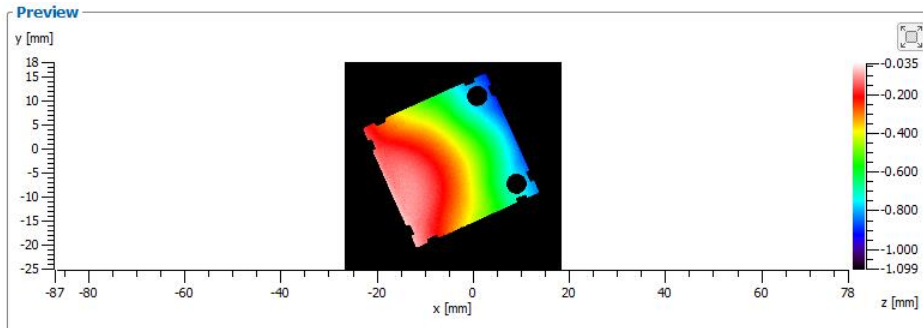

Fig. 4.7: Preview window

3DInspect offers the possibility to maximize the preview window. Press the button "Maximize Preview" or "Restore Preview".



Fig. 4.8: "Maximize/Restore Preview" button

4.4.2 Description of the 2D-View

The 2D-View visualizes the last measured point cloud of the sensor as a 2½-D image. After executing the measurement the point cloud displayed in the 2D-View. The colored texture of the display represents the height values of the individual points.

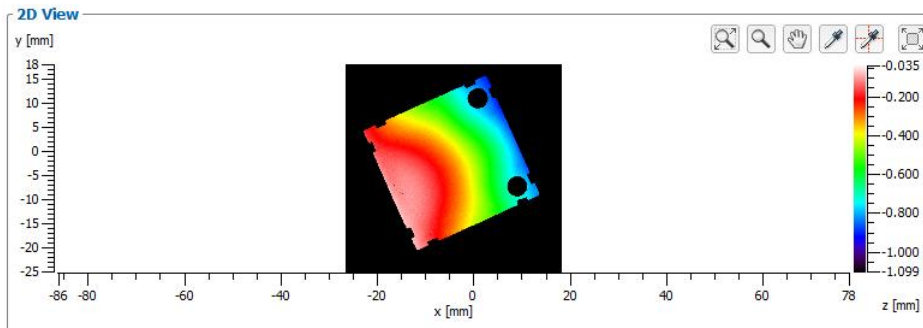

Fig. 4.9: 2D-View

The 2D-View offers the following interaction options:

- **Zooming in/out the range:** Enable the "Zoom" mode by pressing the "Zoom" button (see Fig. 4.10). Press the left mouse button and keep it pressed to draw out a range. The 2D-View then completely visualizes the marked range when you release the mouse button. You can mark a range as often as required and zoom in the marked range. You use this function to display certain ranges with particular detail. Alternatively, you can use the mouse wheel to zoom in and out.



Fig. 4.10: "Zoom" button

In order to display the data completely in the 2D-View, press the "Fit to window" button (see Fig. 4.11)



Fig. 4.11: "Fit to window" button

- **Moving of the range:** Enable the "Move" mode by pressing the "Move" button (see Fig. 4.12). Press the left mouse button and move the range. Release the mouse button.



Fig. 4.12: "Move" button

- **Display extended information of a point:** Press the correspondent button (see Fig. 4.13) to activate or deactivate the "Pipette" mode. Press the left mouse button on the desired point. The information for the point will now be displayed in a tooltip next to the mouse pointer.



Fig. 4.13: "Pipette" button

- **Profile mode:** 3DInspect offers the possibility to display the height information along the X and Y axis at a defined point as profile section (see Fig. 4.14). Press the "Pipette+Profile" button (see Fig. 4.15) in order to activate the profile mode. Press the left mouse button on the desired point. The information for the point will now be displayed in a tooltip next to the mouse pointer and the profile section will be displayed under and accordingly next to the respective axis.

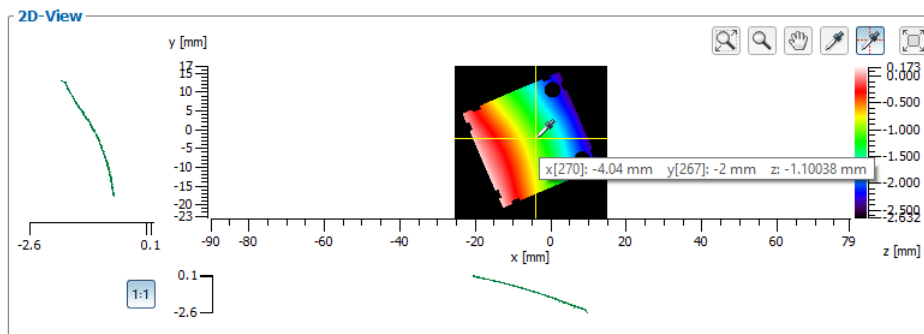

Fig. 4.14: "Profile mode" view



Fig. 4.15: "Pipette+Profile" button

To compare the profile evaluation along the X and Y axis, press the "Keep z scaling for row and column data" button (see Fig. 4.16). Activating this option both profile views are scaled equally in z direction. Deactivating this option the scaling is adapted separately in both profile views to the actual values in z direction.



Fig. 4.16: "Keep z scaling for row and column data" button

- **Maximize 2D-View:** 3DInspect offers the possibility to maximize the 2D-View. Press the button "Maximize 2D-View" or "Restore 2D-View" (see Fig. 4.17).



Fig. 4.17: "Maximize/Restore 2D-View" button

4.5 Description of the "2D-View" Tab (ProfileUnit)

The "2D-View" view visualizes the last measured profile of the ProfileUnit system.

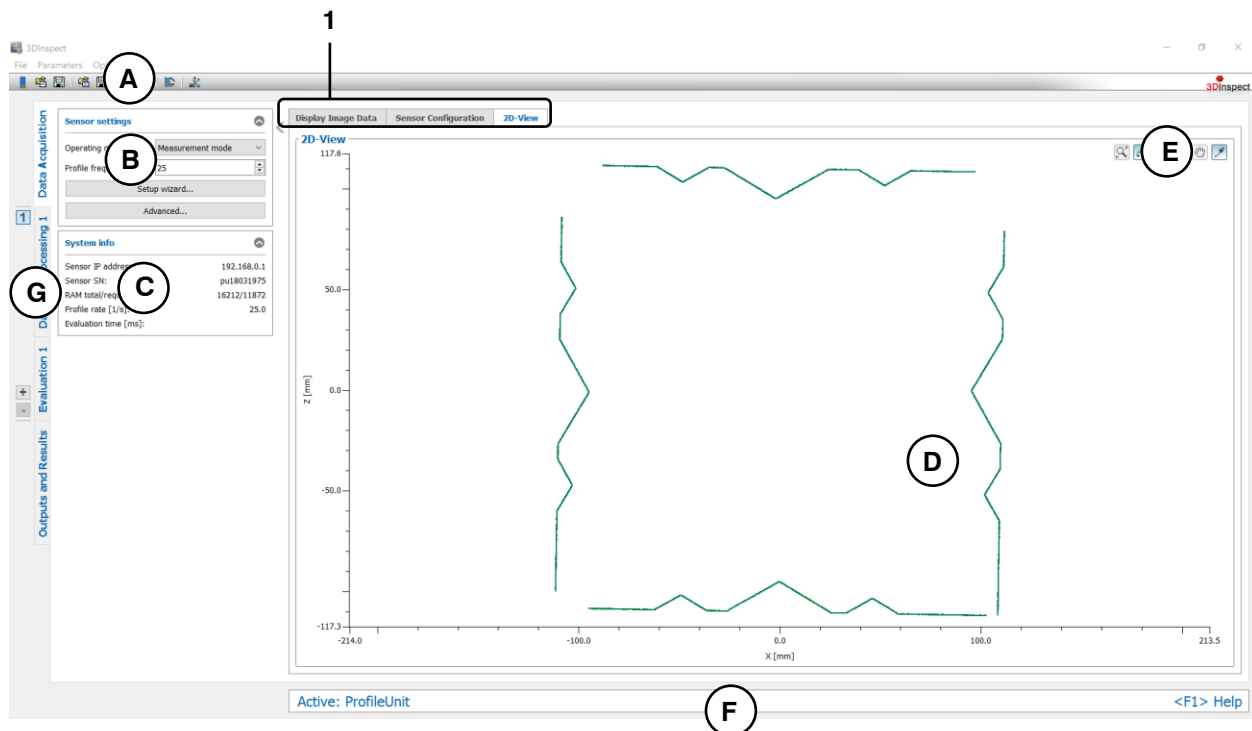

Fig. 4.18: "2D-View" tab (ProfileUnit)

Display elements and parameters in the "2D-View" tab (ProfileUnit):

- A** **"General" toolbar:** Using this toolbar, you can select the data source (see Chapter 3.4 and 3.5), save and load parameters (see Chapter 3.20), reset selected parameters to default settings (see Chapter 3.20.3) and undo and restore changes of settings and parameters (see Chapter 3.21).
- B** **Sensor settings:** Change the settings of the sensor with these values. Detail information about each parameter can be found in Chapters 3.4.5.
- C** **Status display:** The status display shows current sensor information and the last measurement that was carried out (see Chapter 3.7).
- D** **2D-View:** The 2D-View visualizes the 2D data (see Chapter 3.13).
- E** **"2D Profile View" toolbar:** Use this toolbar to scale the 2D Profile View and activate various options for mouse interaction (see Chapter 3.13).
- F** **Status line:** Status and error messages are displayed on the status line (see Chapter 8.1).
- G** **Tab bar for switching between views:** This tab bar allows you to switch between the four main views (see Chapter 3.2).
- 1** **Tab bar for switching between subviews:** This tab bar allows you to switch between the subviews of the "Data acquisition" view (see Chapter 4).

5. Description of the "Data Preprocessing" View

In this view, you can select and parameterize programs for preprocessing the measurement data.

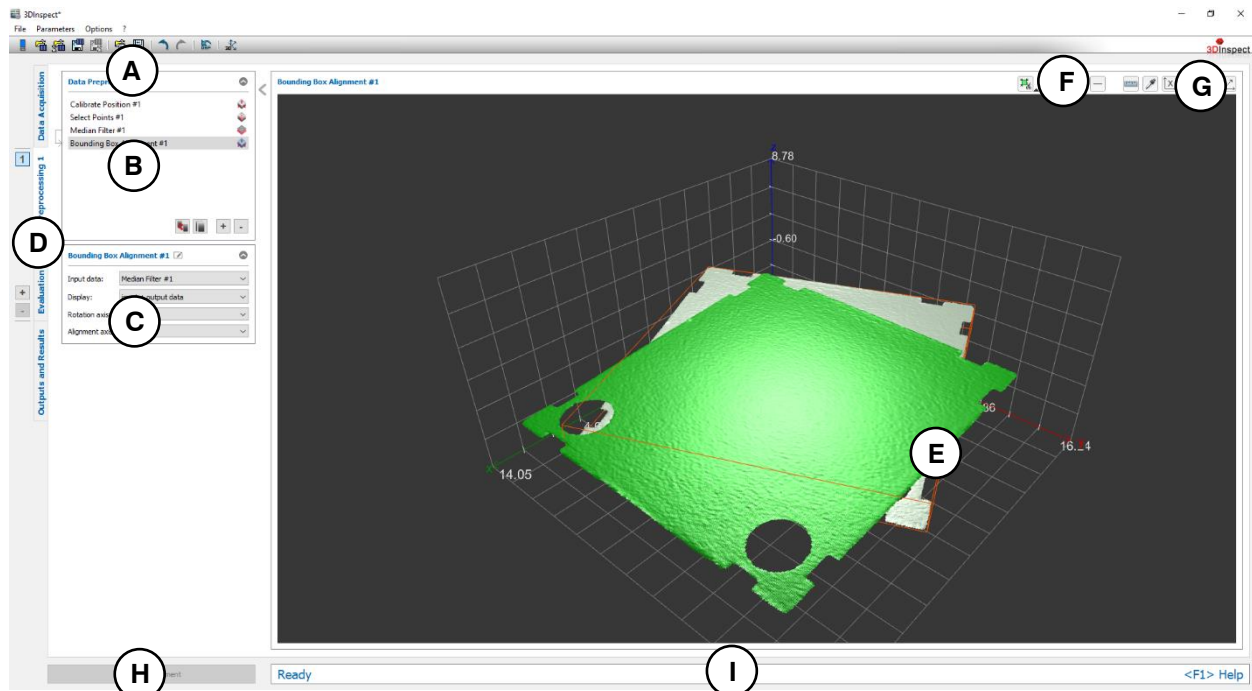

Fig. 5.1: Data preprocessing" view

Display Elements and Parameters in the "Data Preprocessing" View:

- A** **"General" toolbar:** Using this toolbar, you can select the data source (see Chapter 3.4 and 3.5), save and load parameters and reset selected parameters to default settings (see Chapter 3.20.3).
- B** **List of active measuring programs:** This section displays the active measuring programs from the "Data preprocessing" group. You can add and remove measuring programs (see Chapter 3.15), move them (see Chapter 3.16) and select an active measuring program for parameterizing and displaying the measured values.
- C** **Measuring program parameters:** In this section you can configure the currently selected measuring program (see Chapter 3.18).
- D** **Measuring program groups / Tab bar for switching between views:** This tab bar allows you to switch between the four main views (see Chapter 3.2). To the left of the tab bar you find the section for adding, removing and selecting measuring program groups (see Chapter 3.17).
- E** **2D Profile View/3D-View:** If the measuring program is a 2D measuring program the 2D Profile View visualizes the selected 2D profile (see Chapter 3.13), else the 3D-View shows the last measured point cloud of the sensor or the input/output point cloud of the currently selected measuring program (see Chapter 3.11).
- F** **"Measuring" toolbar:** Use this toolbar to set various ROIs for the measurement (see Chapter 3.18.4, 3.18.5, 3.18.6 and 3.18.7).
- G** **"2D-View"/"3D-View" toolbar:** Use this toolbar to configure the orientation of the coordinate system and activate various options for mouse interaction in the 2D Profile View in the 2D mode (see Chapter 3.13) or the 3D-View in the 3D mode (see Chapter 3.11).
- H** **"Start measurement" button:** Click on this button to perform a measuring operation, calculate the measurement results and display the point cloud and measurement results of the currently selected measuring program in the 3D-View.
- I** **Status bar:** Status and error messages are displayed in the status bar (see Chapter 8.1).

5.1 Description of the Measuring Programs in the "Data Preprocessing" Group

In this group, you will find programs for selecting, filtering, transforming and aligning 3D point clouds and 2D profiles.

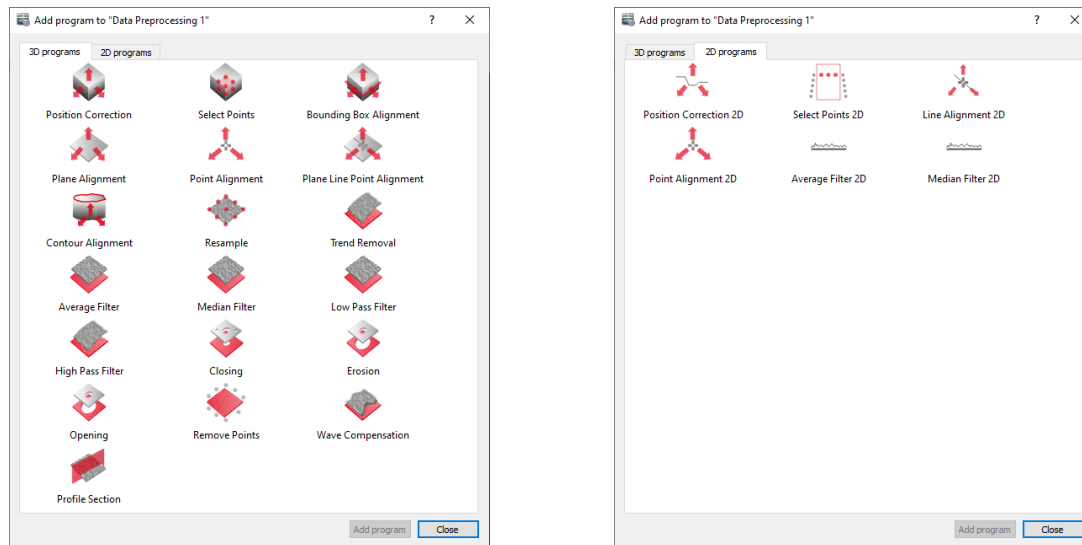

Fig. 5.2: "Data preprocessing" group for 2D and 3D data

Measuring Programs in the "Data Preprocessing" Group:

- Position Correction: Adjusting the mounting position of the sensor using a static rotation and translation (see Chapter 5.1.1).
- Select points: Select 3D points by using regions of interest and discard the remaining points see Chapter 5.1.2).
- Bounding Box Alignment: Align a point cloud by means of a bounding box (see Chapter 5.1.3).
- Plane Alignment: Align a point cloud by means of a plane (see Chapter 5.1.4).
- Point Alignment: Align a point cloud by means of a point (see Chapter 5.1.5).
- Plane Line Point Alignment: Align a point cloud by means of a plane, a line and a point (see Chapter 5.1.6).
- Contour Alignment: Align a point cloud by means of a contour (see Chapter 5.1.7).
- Resample: Resamples the point cloud and creates a point cloud which has a grid with defined point distances in x and y direction. (see Chapter 5.1.8).
- Trend Removal: Remove a trend of a point cloud (see Chapter 5.1.9).
- Average Filter: Filter a point cloud by using an average filter (see Chapter 5.1.10).
- Median Filter: Filter a point cloud by using a median filter (see Chapter 5.1.11).
- Low Pass Filter: Filter a point cloud by using a low pass filter (see Chapter 5.1.12).
- High Pass Filter: Compute the difference of a point cloud which has been filtered with a low pass filter from the original point cloud (see Chapter 5.1.13).
- Closing: Fill gaps of a point cloud by using a dilatation and an erosion filter (see Chapter 5.1.14).
- Erosion: Filter a point cloud by using an erosion filter (see Chapter 5.1.15).
- Opening: Enlarge gaps of a point cloud by using a dilatation and an erosion filter (see Chapter 5.1.16).
- Remove Points: Remove isolated points (see Chapter 5.1.17).
- Wave compensation: Compensate waves in y direction (see Chapter 5.1.18).
- Profile Section: Generate a 2D profile from a 3D point cloud (see Chapter 5.1.19), which is necessary as data source for 2D-measuring programs.
- Position Correction 2D: Adjusting the mounting position of the sensor using a static rotation and translation (see Chapter 5.1.20).
- Select points 2D: Select 2D points by using regions of interest and discard the remaining points see Chapter 5.1.21).
- Line Alignment 2D: Align a 2D profile by means of a line (see Chapter 5.1.23).
- Point Alignment 2D: Align a 2D profile by means of a point (see Chapter 5.1.23).
- Average Filter 2D: Filter a 2D profile by using an average filter (see Chapter 5.1.24).
- Median Filter 2D: Filter a 2D profile by using a median filter (see Chapter 5.1.25).

5.1.1 "Position Correction" Measuring Program

Use the "Position Correction" program to correct tilting and displacements caused by the mounting position of the sensor. You can rotate and move the point cloud and store the resulting correction of the 3D points permanently in the measuring program. You can manually edit the values for the correction or automatically determine the correction values using a plane fit. By this the values are determined such that the fitted plane lies horizontally in the coordinate system and the center of gravity of the fitted points is at the center of the coordinate system. Proceed as follows:

- If applicable, select the input data for the position correction (see below, section "1" and Chapter 3.18.3).
- Manually entry of values:
 - Enter the desired values for the rotation and translation (see below, section "2")
- Automatic determination of values:
 - Activate the setup mode of the measuring program (see below, section "4"). A plane is then fitted to the 3D points of the point cloud.
 - If necessary, limit the range for the plane fit in order to eliminate interfering points (see section "E" and Chapter 3.18.4, 3.18.6 and 3.18.7).
 - Click on the "Calculate values" button (see below, section "5"). The point cloud is aligned such that the fitted plane lies horizontally in the coordinate system and the center of gravity of the fitted points is at the center of the coordinate system.
 - Deactivate the setup mode (see below, section "4").
- If applicable, select measured values that are to be used later for calculation, OK/nOK assessment, logging and output (see below, section "H" and Chapter 3.18.9).

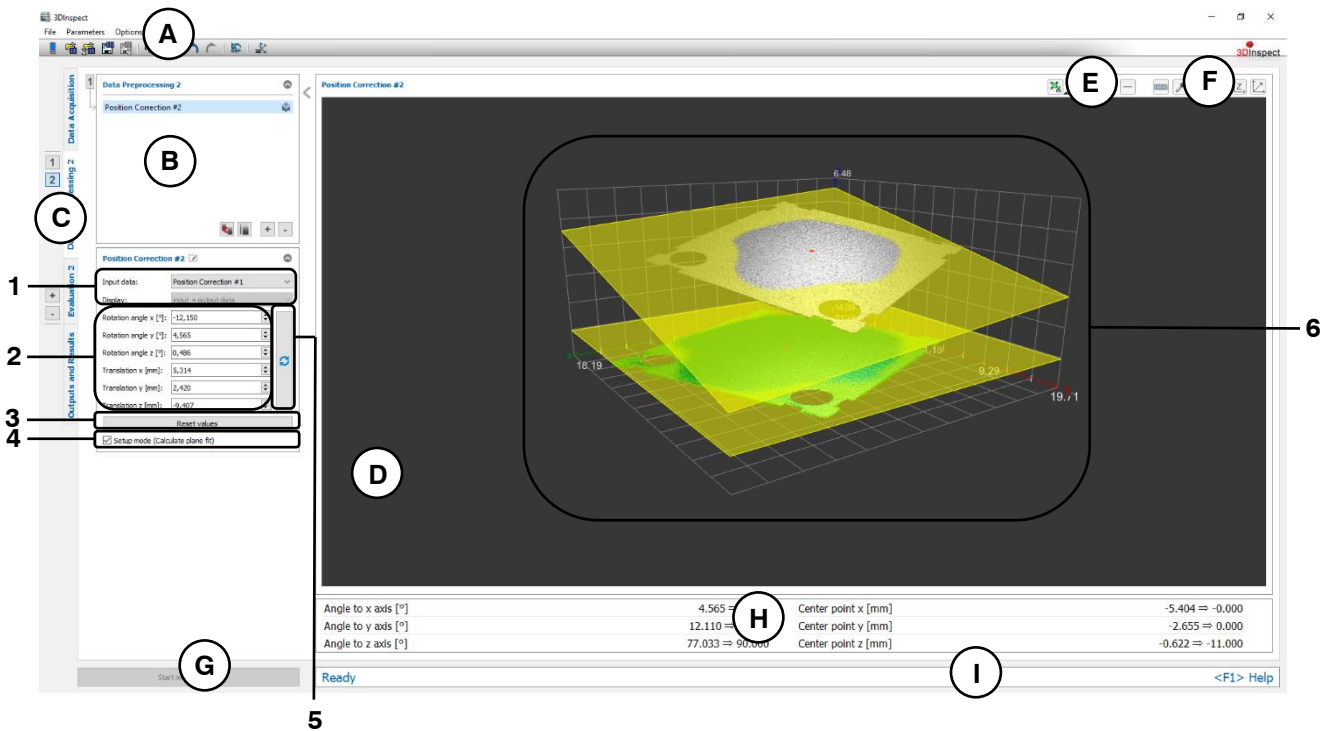

Fig. 5.3: "Position Correction" Measuring Program

Display Elements and Parameters in the "Position Correction" Program:

- A "General" toolbar:** Using this toolbar, you can select the data source (see Chapter 3.4 and 3.5), save and load parameters (see Chapter 3.20), reset selected parameters to default settings (see Chapter 3.20.3) and undo and restore changes of settings and parameters (see Chapter 3.21).
- B List of active measuring programs:** This section displays the active measuring programs from the "Data preprocessing" group. You can add and remove measuring programs (see Chapter 3.15), move them (see Chapter 3.16) and select an active measuring program for parameterizing and displaying the measured values.
- C Measuring program groups / Tab bar for switching between views:** This tab bar allows you to switch between the four main views (see Chapter 3.2). To the left of the tab bar you find the section for adding, removing and selecting measuring program groups (see Chapter 3.17).
- D 3D-View:** The 3D-View visualizes the 3D data (see Chapter 3.11).
- E "Measuring" toolbar:** Use this toolbar to set various ROIs for the measurement (see Chapter 3.18.4, 3.18.6 and 3.18.7).
- F "3D-View" toolbar:** Use this toolbar to configure the orientation of the coordinate system and activate various options for mouse interaction in the 3D-View (see Chapter 3.11).
- G "Start measurement" button:** Click on this button to perform a measuring operation, calculate the measurement results and display the point cloud and measurement results of the currently selected measuring program in the 3D-View.
- H Results display:** By default, the characteristics of the cumulative transformation (Euler angle X/Y/Z, translation X/Y/Z and the inverse values) resulting from all previous programs and from the current program are displayed. In setup mode, the characteristic data of the original plane and of the transformed plane are displayed.
- I Status bar:** Status and error messages are displayed in the status bar (see Chapter 8.1).
- 1**
- **Input data:** Use this selection field to select the input data for the program (see also Chapter 3.18.3).
 - **Display:** Select whether input data, output data or both is displayed in the 3D-View (This selection is not available if setup mode is active).
- 2 Correction settings:**
- **Rotation angle x/y/z [°]:** The Euler angle in the relevant direction about which the point cloud is rotated. The origin of the coordinate system is used as center of rotation. The Euler angles are applied in the following order: X axis, Y axis, Z axis.
 - **Translation x/y/z [mm]:** The offset by which the point cloud is moved in the relevant direction.
- 3 Reset values:** Resets the "Rotation angle X/Y/Z" and "Translation X/Y/Z" values to zero.
- 4 Setup mode:** This option field allows you to activate or deactivate setup mode.
- 5 Calculate values:** In setup mode, click on this button to calculate the Euler angles and offset such that the fitted plane lies horizontally in the coordinate system and the center of gravity of the fitted points is at the center of the coordinate system.
- 6 3D-View:** In the 3D-View, the input point cloud (gray) and the transformed point cloud (green) are displayed. In setup mode, the original and the transformed plane and, if applicable, the ROIs are also displayed.

Note: The position correction is performed as follows: first, the rotation around the origin of the coordinate system, then the movement of the profile.

5.1.2 "Select Points" Measuring Program

Use the "Select Points" program to select 3D points from the ROIs and to discard the remaining points. This can be useful if, for example, parts of the holder or support surface of the measured object are within the measuring field or in the event of reflections not produced by the measured object. You can use up to four ROIs. For each ROI, you can select whether the points inside or outside the ROI should be discarded. Discarded points are shown in gray, and selected points are shown in green and can be used as input data in subsequent measuring programs. Proceed as follows:

- If applicable, select the input data for the program (see below, section "1" and Chapter 3.18.3).
- Set the parameters for the ROIs in order to eliminate interfering points (see below, section "E" and Chapter 3.18.4, 3.18.6 and 3.18.7).

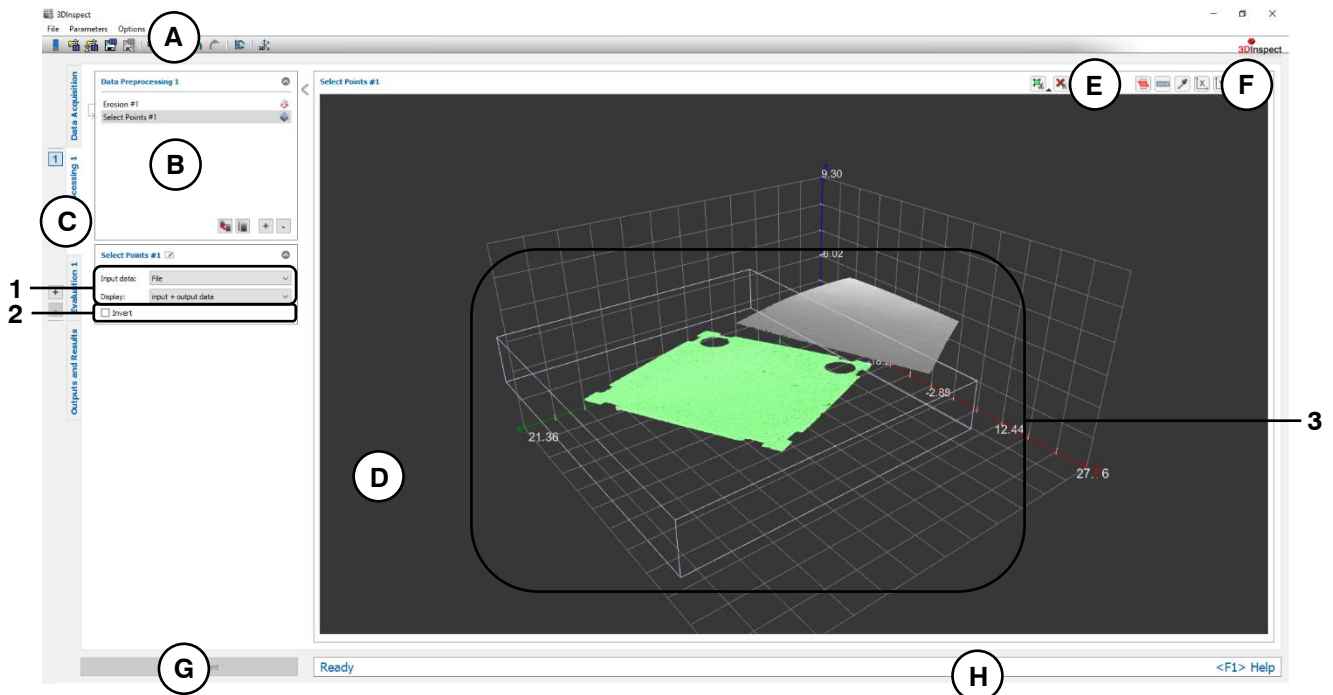

Fig. 5.4: "Select Points" Measuring Program

Display Elements and Parameters in the "Select Points" Program:

- A "General" toolbar:** Using this toolbar, you can select the data source (see Chapter 3.4 and 3.5), save and load parameters and reset selected parameters to default settings (see Chapter 3.20.3).
 - B List of active measuring programs:** This section displays the active measuring programs from the "Data preprocessing" group. You can add and remove measuring programs (see Chapter 3.15), move them (see Chapter 3.16) and select an active measuring program for parameterizing and displaying the measured values.
 - C Measuring program groups / Tab bar for switching between views:** This tab bar allows you to switch between the four main views (see Chapter 3.2). To the left of the tab bar you find the section for adding, removing and selecting measuring program groups (see Chapter 3.17).
 - D 3D-View:** The 3D-View visualizes the 3D data (see Chapter 3.11).
 - E "Measuring" toolbar:** Use this toolbar to set the ROIs (see Chapter 3.18.4, 3.18.6 and 3.18.7).
 - F "3D-View" toolbar:** Use this toolbar to configure the orientation of the coordinate system and activate various options for mouse interaction in the 3D-View (see Chapter 3.11).
 - G "Start measurement" button:** Click on this button to perform a measuring operation, calculate the measurement results and display the point cloud and measurement results of the currently selected measuring program in the 3D-View.
 - H Status bar:** Status and error messages are displayed in the status bar (see Chapter 8.1).
- 1**
 - **Input data:** Use this selection field to select the input data for the program (see also Chapter 3.18.3).
 - **Display:** Select whether input data, output data or both is displayed in the 3D-View.

- 2 Invert:** Check this box to invert the selection of points.
- 3 3D-View:** In the 3D-View, the discarded points (gray) and the selected points (green) are displayed.

5.1.3 "Bounding Box Alignment" Measuring Program

Use the "Bounding Box Alignment" program to align a point cloud. This step allows to compensate for changes to the orientation and position of the object in different measurements. Therefore, ROIs that are used in subsequent measuring programs are not affected by the position and orientation changes and can be used at defined positions relative to the object.

The measuring program calculates an enclosing box at selected points. The point cloud is rotated about one of the three coordinate axes and moved such that the box is parallel to the two remaining coordinate axes and the center of gravity of the box is in the origin of the coordinate system.

The enclosing box is calculated as follows: First, the point cloud is projected onto the plane defined by the axis of rotation. An enclosing rectangle is calculated based on the projected points. The height of the box is given by the minimum and maximum coordinates of the points along the axis of rotation.

Note: If the object being measured is not point-symmetrical, the program can compensate for rotations of up to max. 180° in one range by virtue of the symmetry properties of the box.

Proceed as follows:

- If applicable, select the input data for the program (see below, section "1" and Chapter 3.18.3).
- If necessary, limit the range for the box calculation in order to eliminate interfering points (see section "E" and Chapter 3.18.4, 3.18.6 and 3.18.7).
- Select the axis of rotation and, if applicable, the axis for alignment (see below, section "2").
- If applicable, select measured values that are to be used later for calculation, OK/nOK assessment, logging and output (see below, section "H" and Chapter 3.18.9).

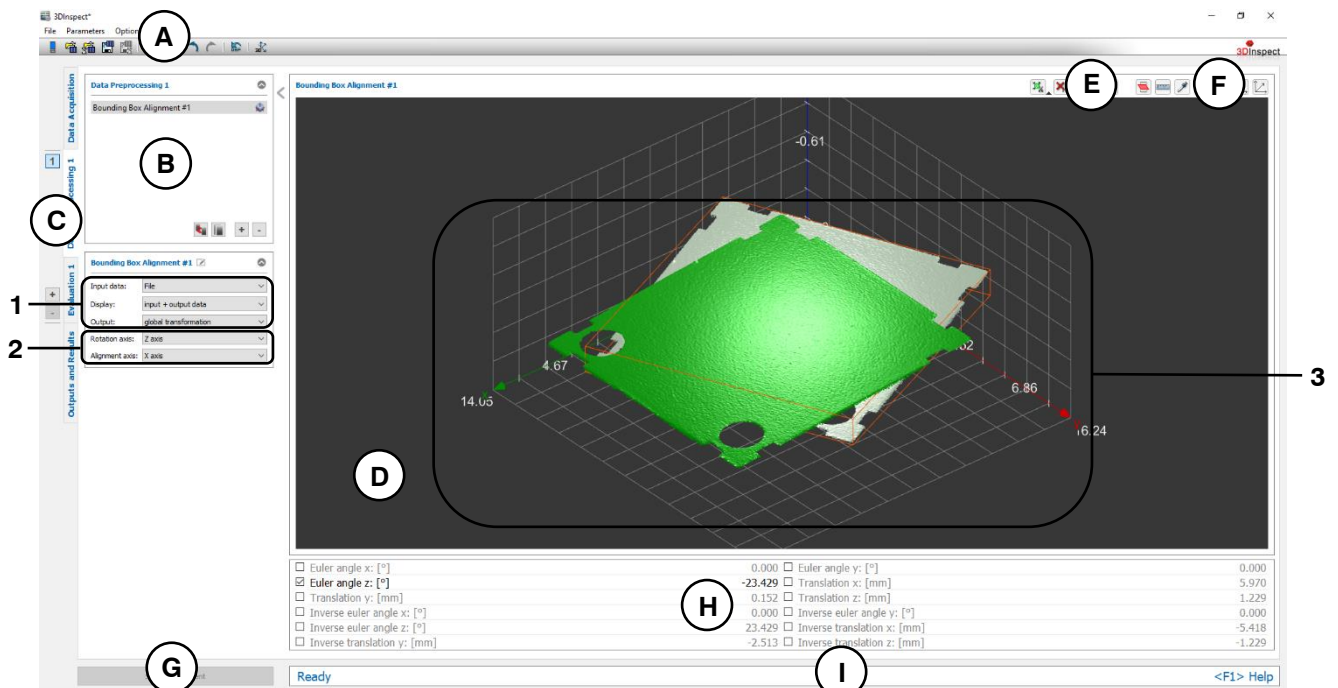

Fig. 5.5: "Bounding Box Alignment" Measuring Program

Display Elements and Parameters in the "Bounding Box Alignment" Program:

- A "General" toolbar:** Using this toolbar, you can select the data source (see Chapter 3.4 and 3.5), save and load parameters (see Chapter 3.20), reset selected parameters to default settings (see Chapter 3.20.3) and undo and restore changes of settings and parameters (see Chapter 3.21).
- B List of active measuring programs:** This section displays the active measuring programs from the "Data preprocessing" group. You can add and remove measuring programs (see Chapter 3.15), move them (see Chapter 3.16) and select an active measuring program for parameterizing and displaying the measured values.
- C Measuring program groups / Tab bar for switching between views:** This tab bar allows you to switch between the four main views (see Chapter 3.2). To the left of the tab bar you find the section for adding, removing and selecting measuring program groups (see Chapter 3.17).
- D 3D-View:** The 3D-View visualizes the 3D data (see Chapter 3.11).
- E "Measuring" toolbar:** Use this toolbar to set various ROIs for the measurement (see Chapter 3.18.4, 3.18.6 and 3.18.7).
- F "3D-View" toolbar:** Use this toolbar to configure the orientation of the coordinate system and activate various options for mouse interaction in the 3D-View (see Chapter 3.11).
- G "Start measurement" button:** Click on this button to perform a measuring operation, calculate the measurement results and display the point cloud and measurement results of the currently selected measuring program in the 3D-View.
- H Results display:** The characteristics of the transformation (Euler angle X/Y/Z, translation X/Y/Z and the inverse values) are displayed.
- I Status bar:** Status and error messages are displayed in the status bar (see Chapter 8.1).
- 1**
- **Input data:** Use this selection field to select the input data for the program (see also Chapter 3.18.3).
 - **Display:** Select whether input data, output data or both is displayed in the 3D-View.
 - **Output:** Select the type of output of the transformation results. With the option "Global transformation" the cumulative transformation, which results from all predecessor programs and from the current program, is output. With the "Local transformation" option, only the transformation of the current program is output.
- 2**
- **Rotation axis:** Select the axis of rotation about which you want the point cloud to rotate. The axis defines, among other things, the plane used for projecting the points and for calculating the enclosing rectangle (see above).
 - **Alignment axis:** If you have selected the Z axis as the axis of rotation, you can additionally specify whether the longitudinal side of the enclosing rectangle should be aligned in parallel with the X axis or the Y axis using the parameter "Axis for alignment" (see above, section "2").
- 3**
- 3D-View:** The 3D-View shows the input point cloud (gray), the calculated box on the input point cloud and the aligned point cloud (green).

5.1.4 "Plane Alignment" Measuring Program

Use the "Plane Alignment" program to align a point cloud. This step allows to compensate for changes to the pitch of the object in different measurements. Therefore, ROIs that are used in subsequent measuring programs are not affected by the pitch changes and can be used at defined positions relative to the object.

The object is rotated about a selectable rotation point so that the reference plane is parallel to the xy plane. Additionally, the position of the object may be compensated. By this the object will be translated so that the rotation point is equal to the center of the coordinate system.

Note: In addition to the input point cloud, the "Plane Alignment" measuring program requires a reference plane and a rotation point as input data. These objects have to be computed with the "Plane Fit" measuring program (see Chapter 6.1.3) which has to be in a previous program group. Alternatively you may use another measuring program for computation of the rotation point (see below, Section 1).

Proceed as follows:

- First, if you have not already, activate the "Evaluation" view (see Chapter 6), insert the "Plane Fit" measuring program and configure the measuring program in order to obtain a reference plane and a rotation point (see Chapter 6.1.3). Alternatively you may use another measuring program for computation of the rotation point (see below, Section 1).
- Now, create a new program group (see Chapter 3.17) and insert the "Plane Alignment" program in the "Data preprocessing" section.
- Select the input point cloud, the reference plane and the rotation point for the program (see below, section "1" and Chapter 3.18.3).
- If required, activate the position correction of the object in addition to the pitch correction (see below, section "2").
- If applicable, select measured values that are to be used later for calculation, OK/nOK assessment, logging and output (see below, section "H" and Chapter 3.18.9).

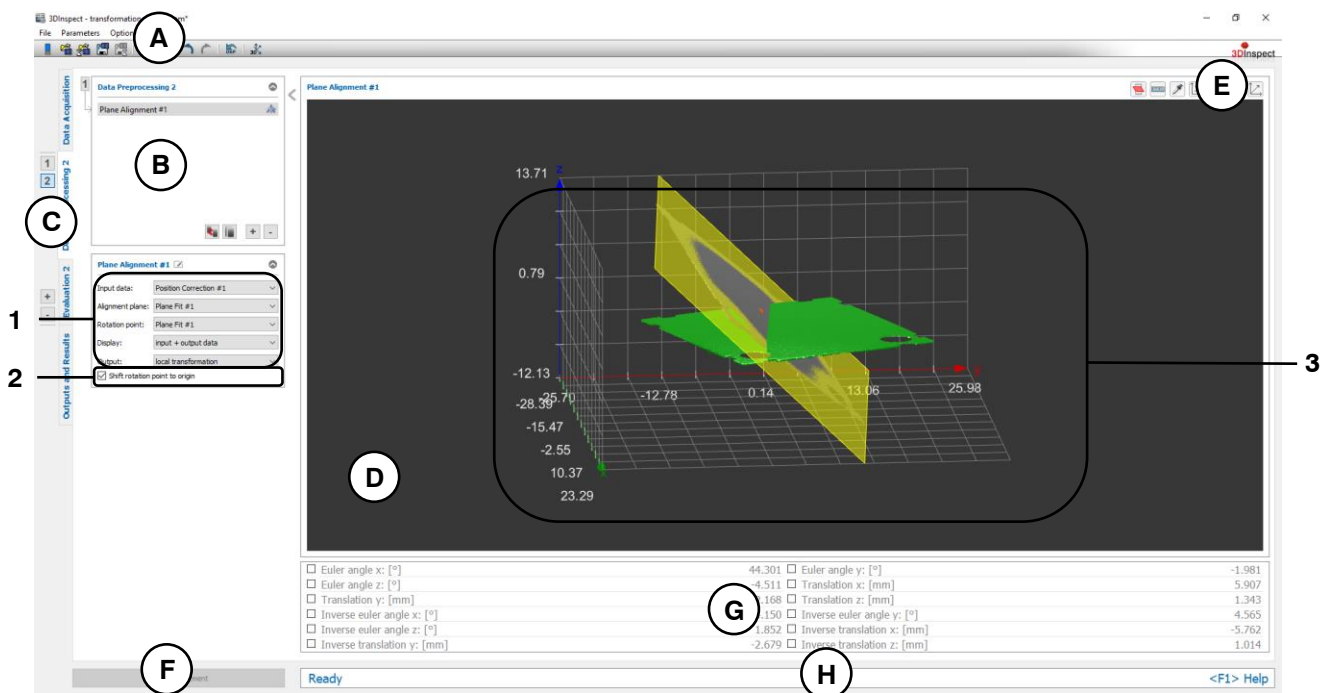

Fig. 5.6: "Plane Alignment" Measuring Program

Display Elements and Parameters in the "Plane Alignment" Program:

- A "General" toolbar:** Using this toolbar, you can select the data source (see Chapter 3.4 and 3.5), save and load parameters (see Chapter 3.20), reset selected parameters to default settings (see Chapter 3.20.3) and undo and restore changes of settings and parameters (see Chapter 3.21).
- B List of active measuring programs:** This section displays the active measuring programs from the "Data preprocessing" group. You can add and remove measuring programs (see Chapter 3.15), move them (see Chapter 3.16) and select an active measuring program for parameterizing and displaying the measured values.
- C Measuring program groups / Tab bar for switching between views:** This tab bar allows you to switch between the four main views (see Chapter 3.2). To the left of the tab bar you find the section for adding, removing and selecting measuring program groups (see Chapter 3.17).
- D 3D-View:** The 3D-View visualizes the 3D data (see Chapter 3.11).
- E "3D-View" toolbar:** Use this toolbar to configure the orientation of the coordinate system and activate various options for mouse interaction in the 3D-View (see Chapter 3.11).
- F "Start measurement" button:** Click on this button to perform a measuring operation, calculate the measurement results and display the point cloud and measurement results of the currently selected measuring program in the 3D-View.
- G Results display:** The characteristics of the transformation (Euler angle X/Y/Z, translation X/Y/Z and the inverse values) are displayed.
- H Status bar:** Status and error messages are displayed in the status bar (see Chapter 8.1).
- 1**
- **Input data:** Use this selection field to select the input data, the reference plane and the rotation point for the program (see also Chapter 3.18.3). An overview of measuring programs, which provide points and planes, can be found in Chapter 3.19.1 and 3.19.3.
 - **Display:** Select whether input data, output data or both is displayed in the 3D-View.
 - **Output:** Select the type of output of the transformation results. With the option "Global transformation" the cumulative transformation, which results from all predecessor programs and from the current program, is output. With the "Local transformation" option, only the transformation of the current program is output.
- 2** **Shift rotation point to origin:** You may activate the position correction of the object in addition to the pitch correction here.
- 3** **3D-View:** The 3D-View shows the input point cloud (gray), the reference plane (yellow), the rotation point (orange) and the aligned point cloud (green).

5.1.5 "Point Alignment" Measuring Program

Use the "Point Alignment" program to align a point cloud. This step allows to compensate for changes to the position of the object in different measurements. Therefore, ROIs that are used in subsequent measuring programs are not affected by the position changes and can be used at defined positions relative to the object.

The object is aligned on a selectable point so that the alignment point becomes the origin of the coordinate system.

Note: In addition to the input point cloud, the "Point Alignment" measuring program requires an alignment point as input data. This point is computed by a measuring program with a point as output value (see Chapter 6) which has to be in a previous program group.

Proceed as follows:

- First, if you have not already, activate the "Evaluation" view (see Chapter 6), insert a measuring program with a point as output value (see below, section "1") and configure this measuring program in order to obtain an alignment point.
- Now, create a new program group (see Chapter 3.17) and insert the "Point Alignment" program in the "Data preprocessing" section.
- Select the input point cloud and the alignment point for the program (see below, section "1" and Chapter 3.18.3).
- If applicable, select measured values that are to be used later for calculation, OK/nOK assessment, logging and output (see below, section "H" and Chapter 3.18.9).

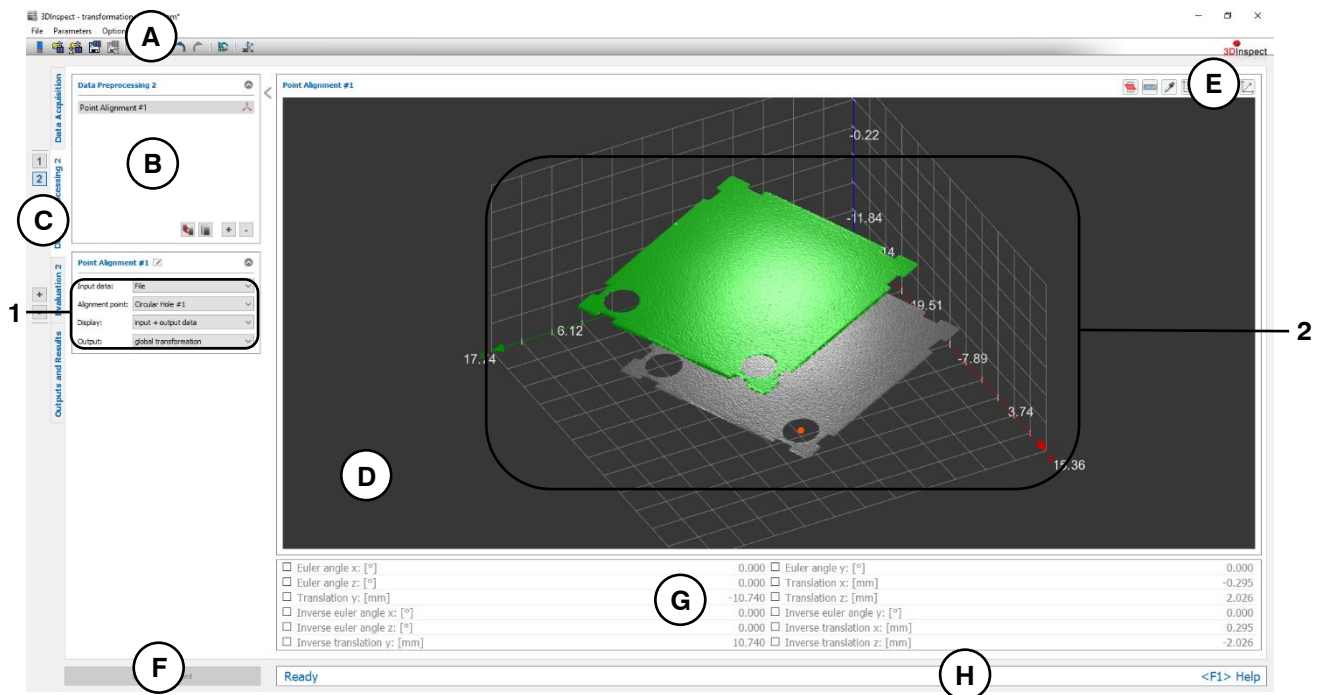

Fig. 5.7: "Point Alignment" Measuring Program

Display Elements and Parameters in the "Point Alignment" Program:

- A "General" toolbar:** Using this toolbar, you can select the data source (see Chapter 3.4 and 3.5), save and load parameters (see Chapter 3.20), reset selected parameters to default settings (see Chapter 3.20.3) and undo and restore changes of settings and parameters (see Chapter 3.21).
- B List of active measuring programs:** This section displays the active measuring programs from the "Data preprocessing" group. You can add and remove measuring programs (see Chapter 3.15), move them (see Chapter 3.16) and select an active measuring program for parameterizing and displaying the measured values.
- C Measuring program groups / Tab bar for switching between views:** This tab bar allows you to switch between the four main views (see Chapter 3.2). To the left of the tab bar you find the section for adding, removing and selecting measuring program groups (see Chapter 3.17).

- D** **3D-View:** The 3D-View visualizes the 3D data (see Chapter 3.11).
- E** **"3D-View" toolbar:** Use this toolbar to configure the orientation of the coordinate system and activate various options for mouse interaction in the 3D-View (see Chapter 3.11).
- F** **"Start measurement" button:** Click on this button to perform a measuring operation, calculate the measurement results and display the point cloud and measurement results of the currently selected measuring program in the 3D-View.
- G** **Results display:** The characteristics of the transformation (Euler angle X/Y/Z, translation X/Y/Z and the inverse values) are displayed.
- H** **Status bar:** Status and error messages are displayed in the status bar (see Chapter 8.1).

- 1**
 - **Input data:** Use this selection field to select the input data and the alignment point (see also Chapter 3.18.3). An overview of measuring programs, which provide points, can be found in Chapter 3.19.1.
 - **Display:** Select whether input data, output data or both is displayed in the 3D-View.
 - **Output:** Select the type of output of the transformation results. With the option "Global transformation" the cumulative transformation, which results from all predecessor programs and from the current program, is output. With the "Local transformation" option, only the transformation of the current program is output.
- 2** **3D-View:** The 3D-View shows the input point cloud (gray), the alignment point (orange) and the aligned point cloud (green).

5.1.6 "Plane Line Point Alignment" Measuring Program

Use the "Plane Line Point Alignment" program to align a point cloud. This step allows to compensate for changes to the orientation and position of the object in different measurements. Therefore, ROIs that are used in subsequent measuring programs are not affected by the pitch changes and can be used at defined positions relative to the object.

The point cloud is aligned by means of a reference plane, a reference line and a reference point so that the following conditions are met:

- The reference plane is equal to the xy plane.
- The reference line is parallel to the x axis with $y = 0$.
- The x coordinate of the reference point is 0.

The aligned point cloud may be inverted in y and z direction, if necessary.

Note: In addition to the input point cloud, the "Plane Line Point Alignment" measuring program requires a reference plane, a reference line and a reference point as input data. These objects have to be computed with different measuring programs, which have to be in a previous program group (see below, section "Input data").

Proceed as follows:

- First, if you have not already, activate the "Evaluation" view (see Chapter 6), insert measuring programs for creating a plane, a straight line and a point and configure the measuring programs.
- Now, create a new program group (see Chapter 3.17) and insert the "Plane Line Point Alignment" program in the "Data preprocessing" section.
- Select the input point cloud, the reference plane, the reference line and the reference point for the program (see below, section "1" and Chapter 3.18.3).
- Select if the point cloud has to be inverted in y and in z direction respectively (see below, section "2").
- If applicable, select measured values that are to be used later for calculation, OK/nOK assessment, logging and output (see below, section "H" and Chapter 3.18.9).

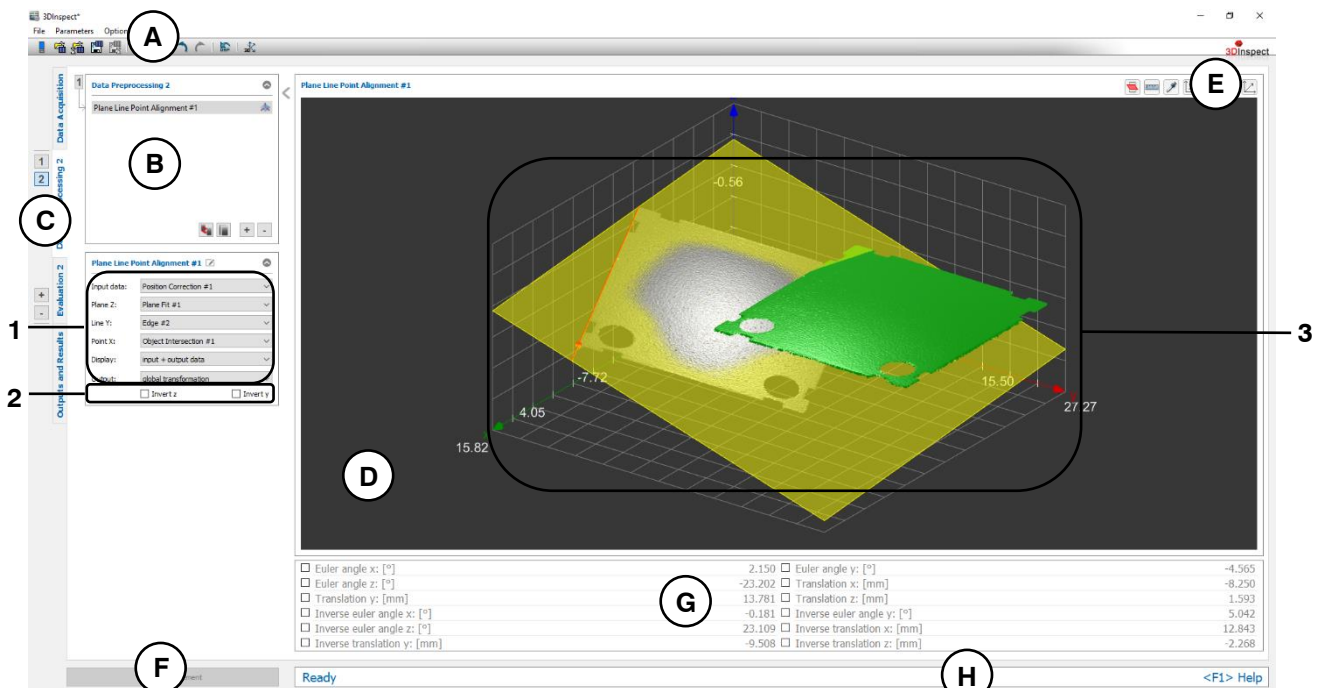

Fig. 5.8: "Plane Line Point Alignment" Measuring Program

Display Elements and Parameters in the "Plane Line Point Alignment" Program:

- A "General" toolbar:** Using this toolbar, you can select the data source (see Chapter 3.4 and 3.5), save and load parameters (see Chapter 3.20), reset selected parameters to default settings (see Chapter 3.20.3) and undo and restore changes of settings and parameters (see Chapter 3.21).
 - B List of active measuring programs:** This section displays the active measuring programs from the "Data preprocessing" group. You can add and remove measuring programs (see Chapter 3.15), move them (see Chapter 3.16) and select an active measuring program for parameterizing and displaying the measured values.
 - C Measuring program groups / Tab bar for switching between views:** This tab bar allows you to switch between the four main views (see Chapter 3.2). To the left of the tab bar you find the section for adding, removing and selecting measuring program groups (see Chapter 3.17).
 - D 3D-View:** The 3D-View visualizes the 3D data (see Chapter 3.11).
 - E "3D-View" toolbar:** Use this toolbar to configure the orientation of the coordinate system and activate various options for mouse interaction in the 3D-View (see Chapter 3.11).
 - F "Start measurement" button:** Click on this button to perform a measuring operation, calculate the measurement results and display the point cloud and measurement results of the currently selected measuring program in the 3D-View.
 - G Results display:** The characteristics of the transformation (Euler angle X/Y/Z, translation X/Y/Z and the inverse values) are displayed.
 - H Status bar:** Status and error messages are displayed in the status bar (see Chapter 8.1).
-
- 1**
 - **Input data:** Use this selection field to select the input data, the reference plane, the reference line and the reference point for the program (see also Chapter 3.18.3). An overview of measuring programs, which provide points, lines and planes, can be found in Chapter 3.19.1, 3.19.2 and 3.19.3.
 - **Display:** Select whether input data, output data or both is displayed in the 3D-View.
 - **Output:** Select the type of output of the transformation results. With the option "Global transformation" the cumulative transformation, which results from all predecessor programs and from the current program, is output. With the "Local transformation" option, only the transformation of the current program is output.
 - 2 Invert Z/Y:** Select whether the point cloud has to be inverted in z and in y direction respectively. The points are rotated 180° around the X or Z axis
 - 3 3D-View:** The 3D-View shows the input point cloud (gray), the reference plane (yellow), the reference line (orange), the reference point (orange) and the aligned point cloud (green).

5.1.7 "Contour Alignment" Measuring Program

Use the "Contour Alignment" program to align a point cloud. This step allows to compensate for changes to the orientation and position of the object in different measurements. Therefore, ROIs that are used in subsequent measuring programs are not affected by the position and orientation changes and can be used at defined positions relative to the object.

In order to use this program a master measurement has to be processed first (Setup mode). The measuring program calculates encircling contours of the object, from which one contour can be selected for the subsequent alignment. The selected contour is stored in the measuring program as template contour then. In measurement mode, the measuring program computes the corresponding contour of the object and aligns the object and the contour so that the contour matches best with the template contour of the master measurement.

Proceed as follows:

- Position your master object at the desired target position for the measurement.
- Insert the "Contour Alignment" program. The setup mode of the program is activated automatically after it has been inserted. You also may activate the setup mode afterwards with the "Setup mode" check box (see Fig. 5.9)
- If applicable, select the input data for the program (see below, section "I" and Chapter 3.18.3).
- If necessary, limit the range of points in order to eliminate interfering points of the contour (see section "E" and Chapter 3.18.4, 3.18.6 and 3.18.7).
- Now the "Template contour" drop down list contains all available contours. Select the contour which you want to use for the object alignment. The selected contour is displayed in blue in the 3D-View.
- Press the "Apply template contour" button in order to store the selected contour as template contour in the measuring program and to quit the setup mode.
- If applicable, select measured values that are to be used later for calculation, OK/nOK assessment, logging and output (see below, section "H" and Chapter 3.18.9).

Note: You also may quit the setup mode by deactivating the "Setup mode" check box. By this the selected contour won't be used as template contour but the previous settings will be used.

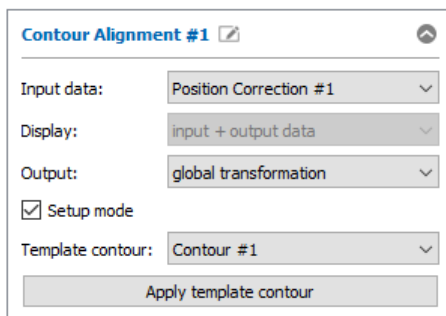

Fig. 5.9: Contour alignment – Settings in setup mode

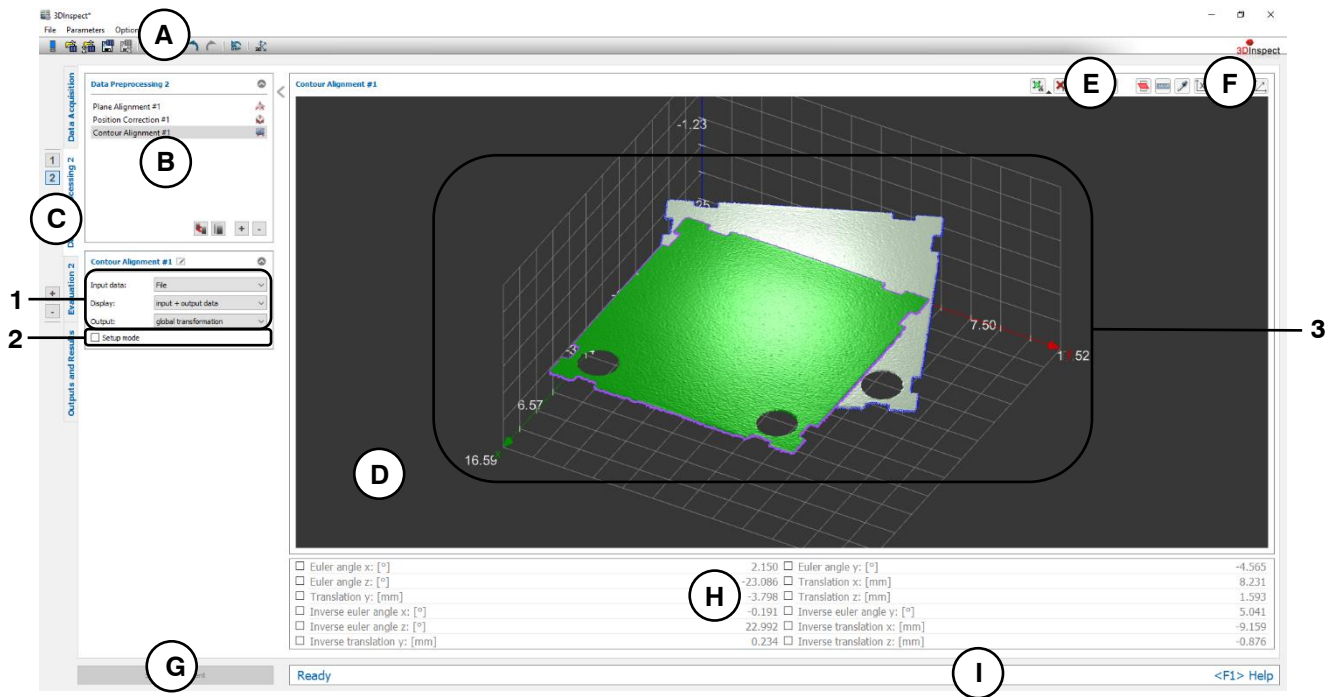

Fig. 5.10: "Contour Alignment" Measuring Program

Display Elements and Parameters in the "Contour Alignment" Program:

- A "General" toolbar:** Using this toolbar, you can select the data source (see Chapter 3.4 and 3.5), save and load parameters (see Chapter 3.20), reset selected parameters to default settings (see Chapter 3.20.3) and undo and restore changes of settings and parameters (see Chapter 3.21).
- B List of active measuring programs:** This section displays the active measuring programs from the "Data preprocessing" group. You can add and remove measuring programs (see Chapter 3.15), move them (see Chapter 3.16) and select an active measuring program for parameterizing and displaying the measured values.
- C Measuring program groups / Tab bar for switching between views:** This tab bar allows you to switch between the four main views (see Chapter 3.2). To the left of the tab bar you find the section for adding, removing and selecting measuring program groups (see Chapter 3.17).
- D 3D-View:** The 3D-View visualizes the 3D data (see Chapter 3.11).
- E "Measuring" toolbar:** Use this toolbar to set various ROIs for the measurement (see Chapter 3.18.4, 3.18.6 and 3.18.7).
- F "3D-View" toolbar:** Use this toolbar to configure the orientation of the coordinate system and activate various options for mouse interaction in the 3D-View (see Chapter 3.11).
- G "Start measurement" button:** Click on this button to perform a measuring operation, calculate the measurement results and display the point cloud and measurement results of the currently selected measuring program in the 3D-View.
- H Results display:** The characteristics of the transformation (Euler angle X/Y/Z, translation X/Y/Z and the inverse values) are displayed.
- I Status bar:** Status and error messages are displayed in the status bar (see Chapter 8.1).
- 1**
- **Input data:** Use this selection field to select the input data for the program (see also Chapter 3.18.3).
 - **Display:** Select whether input data, output data or both is displayed in the 3D-View (This selection is not available if setup mode is active).
 - **Output:** Select the type of output of the transformation results. With the option "Global transformation" the cumulative transformation, which results from all predecessor programs and from the current program, is output. With the "Local transformation" option, only the transformation of the current program is output.

- 2 Setup mode:** Use this parameter in order to activate the setup mode of the program.
- 3 3D-View:** The 3D-View shows the input point cloud (gray) and the aligned point cloud (green). The template contour of the current point cloud is displayed in blue and the target contour (template contour) is displayed in purple.

5.1.8 "Resample" Measuring Program

Use the "Resample" program in order to create a point cloud which has a grid with defined point distances in x and y direction. This step is necessary, when the original grid is destroyed by previous filter operations or if the used sensor type (scanCONTROL 30XX) creates a point cloud without a defined grid. Thus, subsequent filter operations which require a defined grid can be processed.

Proceed as follows:

- If applicable, select the input data for the program (see below, section "1" and Chapter 3.18.3).
- If necessary, define a cube-shaped resampling range (see section "E" and Chapter 3.18.4, 3.18.6 and 3.18.7). Then, the resampling operation is processed exactly in this range. If you do not define a resampling range, the bounding box of the current point cloud is used as resampling range.
- Select the desired values for the resolution in x and y direction (see below, section "2").

Note: The number of points of the resampled point cloud results from the resampling range and the resolution.

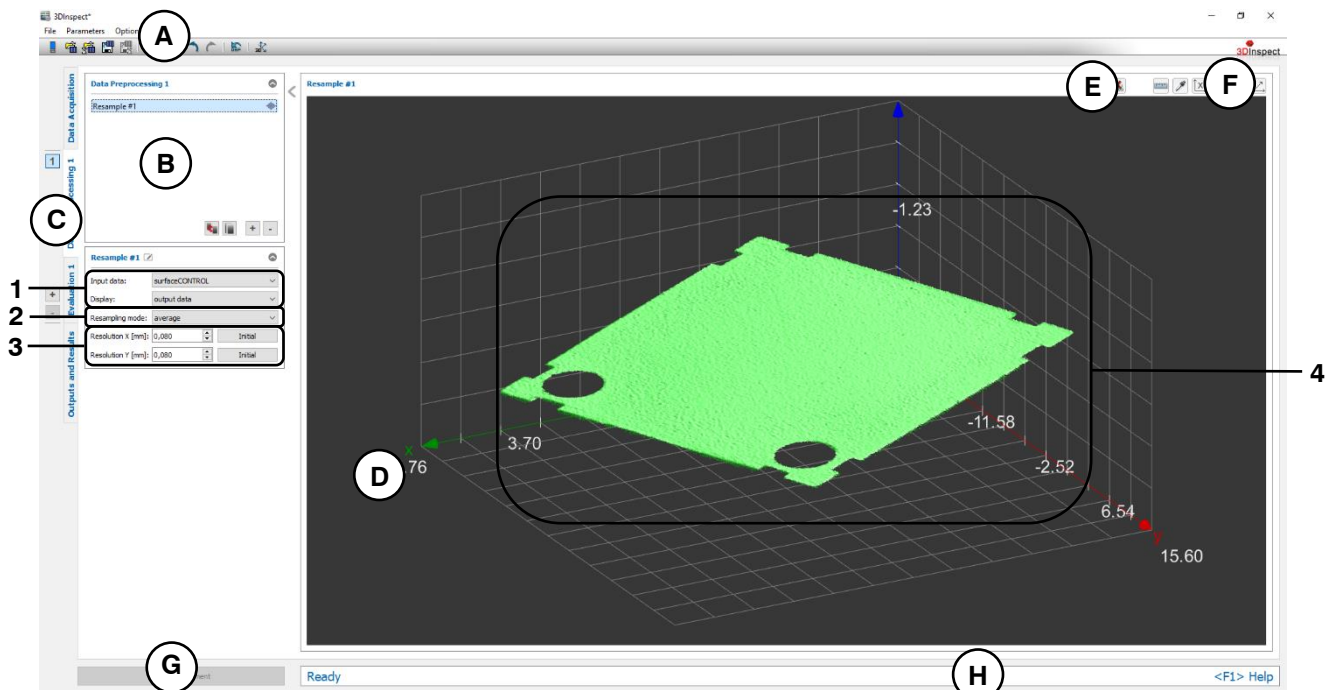

Fig. 5.11: "Resample" Measuring Program

Display Elements and Parameters in the "Resample" Program:

- A "General" toolbar:** Using this toolbar, you can select the data source (see Chapter 3.4 and 3.5), save and load parameters (see Chapter 3.20), reset selected parameters to default settings (see Chapter 3.20.3) and undo and restore changes of settings and parameters (see Chapter 3.21).
- B List of active measuring programs:** This section displays the active measuring programs from the "Data preprocessing" group. You can add and remove measuring programs (see Chapter 3.15), move them (see Chapter 3.16) and select an active measuring program for parameterizing and displaying the measured values.
- C Measuring program groups / Tab bar for switching between views:** This tab bar allows you to switch between the four main views (see Chapter 3.2). To the left of the tab bar you find the section for adding, removing and selecting measuring program groups (see Chapter 3.17).
- D 3D-View:** The 3D-View visualizes the 3D data (see Chapter 3.11).
- E "Measuring" toolbar:** Use this toolbar to set various ROIs for the measurement (see Chapter 3.18.4, 3.18.6 and 3.18.7).
- F "3D-View" toolbar:** Use this toolbar to configure the orientation of the coordinate system and activate various options for mouse interaction in the 3D-View (see Chapter 3.11).

- G** **"Start measurement" button:** Click on this button to perform a measuring operation, calculate the measurement results and display the point cloud and measurement results of the currently selected measuring program in the 3D-View.
- H** **Status bar:** Status and error messages are displayed in the status bar (see Chapter 8.1).
- 1** - **Input data:** Use this selection field to select the input data for the program (see also Chapter 3.18.3).
- **Display:** Select whether input data, output data or both is displayed in the 3D-View (This selection is not available if setup mode is active).
- 2** **Resampling mode:**
- **Average:** Select this mode if there are no overlapping z areas in the point cloud. If you use this mode, the point distance (refer to the "Resolution x/y" parameter) must'nt be smaller than half of the original point distance.
- **Minimum:** The points with minimum z coordinates will be used in the overlapping z areas. This mode is also suitable for small point distances.
- **Maximum:** The points with maximum z coordinates will be used in the overlapping z areas. This mode is also suitable for small point distances.
- 3** **Resolution x/y:** Select the resolution of the grid in X and Y direction. Use the "Initial" buttons in order to use the grid resolution of the point cloud which has been acquired from the sensor.
- 4** **3D-View:** The 3D-View shows the input point cloud (gray) and the resulting point cloud (green).

5.1.9 "Trend Removal" Measuring Program

Use the "Trend Removal" program to remove a point cloud trend. To set the trend, a polynomial is fitted to the point cloud using an approximation method. Then, the evaluation of the fitted polynomial is subtracted from the point cloud. Proceed as follows:

- If applicable, select the input data for the program (see below, section "1" and Chapter 3.18.3).
- If necessary, limit the range for setting the trend in order to eliminate points that do not fit the trend (see section "E" and Chapter 3.18.4, 3.18.6 and 3.18.7).
- Select the form of the trend and, if applicable, the degree of the trend (see below, section "2").

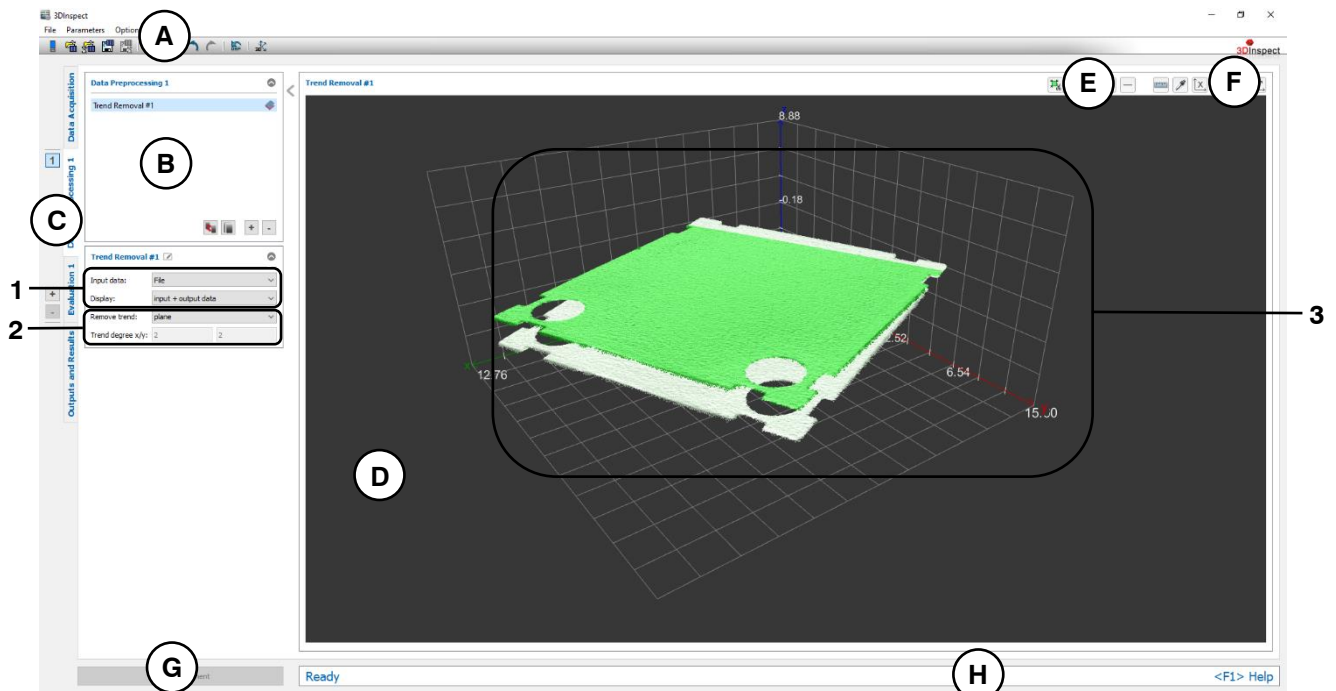

Fig. 5.12: "Trend Removal" Measuring Program

Display Elements and Parameters in the "Trend Removal" Program:

- A "General" toolbar:** Using this toolbar, you can select the data source (see Chapter 3.4 and 3.5), save and load parameters (see Chapter 3.20), reset selected parameters to default settings (see Chapter 3.20.3) and undo and restore changes of settings and parameters (see Chapter 3.21).
 - B List of active measuring programs:** This section displays the active measuring programs from the "Data preprocessing" group. You can add and remove measuring programs (see Chapter 3.15), move them (see Chapter 3.16) and select an active measuring program for parameterizing and displaying the measured values.
 - C Measuring program groups / Tab bar for switching between views:** This tab bar allows you to switch between the four main views (see Chapter 3.2). To the left of the tab bar you find the section for adding, removing and selecting measuring program groups (see Chapter 3.17).
 - D 3D-View:** The 3D-View visualizes the 3D data (see Chapter 3.11).
 - E "Measuring" toolbar:** Use this toolbar to set various ROIs for setting the trend (see Chapter 3.18.4, 3.18.6 and 3.18.7).
 - F "3D-View" toolbar:** Use this toolbar to configure the orientation of the coordinate system and activate various options for mouse interaction in the 3D-View (see Chapter 3.11).
 - G "Start measurement" button:** Click on this button to perform a measuring operation, calculate the measurement results and display the point cloud and measurement results of the currently selected measuring program in the 3D-View.
 - H Status bar:** Status and error messages are displayed in the status bar (see Chapter 8.1).
- 1 - **Input data:** Use this selection field to select the input data for the program (see also Chapter 3.18.3).

- **Display:** Select whether input data, output data or both is displayed in the 3D-View.
- 2 - **Remove trend:** Use this parameter to configure the form of the trend:
 - **Plane:** A trend in the form of a plane is created.
 - **Custom...:** Specify the degree of the trend polynomial:
 - **Trend degree x/y:** The degree of the trend polynomial in the X/Y direction.
- 3 **3D-View:** In the 3D-View, the input point cloud (gray) and the point cloud corrected by the trend (green) are displayed.

Note: The "Trend Removal" program may create data which can't be processed by the "Closing", "Opening", "Low Pass Filter" and "High Pass Filter" programs. In this case a warning message is displayed below the measuring program settings. If you still want to use these programs, you must first resample the point cloud with the "Resample" measuring program (see Chapter [5.1.8](#)).

5.1.10 "Average Filter" Measuring Program

Use the "Average Filter" program to filter a point cloud using an average filter. Proceed as follows:

- If applicable, select the input data for the average filter (see below, section "1" and Chapter 3.18.3).
- Select the filter size (see below, section "2").

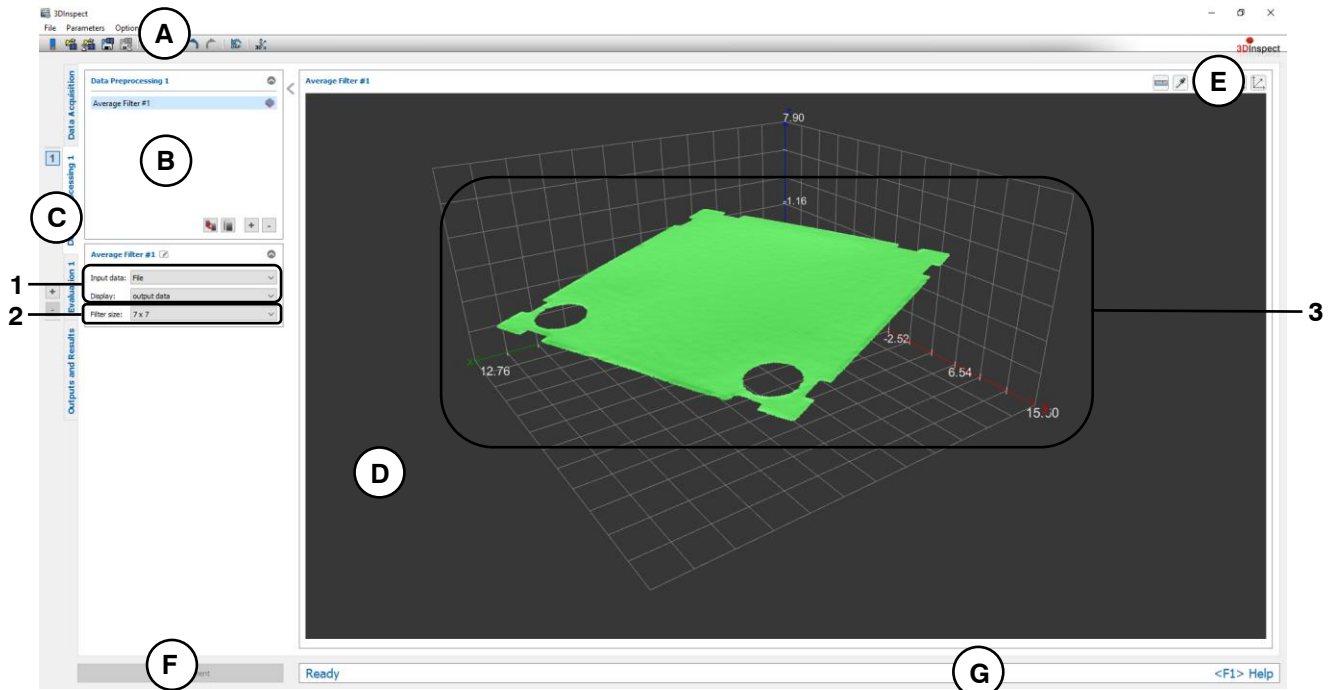

Fig. 5.13: "Average Filter" Measuring Program

Display Elements and Parameters in the "Average Filter" Program:

- A "General" toolbar:** Using this toolbar, you can select the data source (see Chapter 3.4 and 3.5), save and load parameters (see Chapter 3.20), reset selected parameters to default settings (see Chapter 3.20.3) and undo and restore changes of settings and parameters (see Chapter 3.21).
 - B List of active measuring programs:** This section displays the active measuring programs from the "Data preprocessing" group. You can add and remove measuring programs (see Chapter 3.15), move them (see Chapter 3.16) and select an active measuring program for parameterizing and displaying the measured values.
 - C Measuring program groups / Tab bar for switching between views:** This tab bar allows you to switch between the four main views (see Chapter 3.2). To the left of the tab bar you find the section for adding, removing and selecting measuring program groups (see Chapter 3.17).
 - D 3D-View:** The 3D-View visualizes the 3D data (see Chapter 3.11).
 - E "3D-View" toolbar:** Use this toolbar to configure the orientation of the coordinate system and activate various options for mouse interaction in the 3D-View (see Chapter 3.11).
 - F "Start measurement" button:** Click on this button to perform a measuring operation, calculate the measurement results and display the point cloud and measurement results of the currently selected measuring program in the 3D-View.
 - G Status bar:** Status and error messages are displayed in the status bar (see Chapter 8.1).
- 1 - **Input data:** Use this selection field to select the input data for the program (see also Chapter 3.18.3).
 - **Display:** Select whether input data, output data or both is displayed in the 3D-View.
 - 2 **Filter size:** Select the filter size of the average filter.
 - 3 **3D-View:** The filtered point cloud is shown in the 3D-View.

5.1.11 "Median Filter" Measuring Program

Use the "Median Filter" program to filter a point cloud using a median filter. Proceed as follows:

- If applicable, select the input data for the median filter (see below, section "1" and Chapter 3.18.3).
- Select the filter size (see below, section "2").

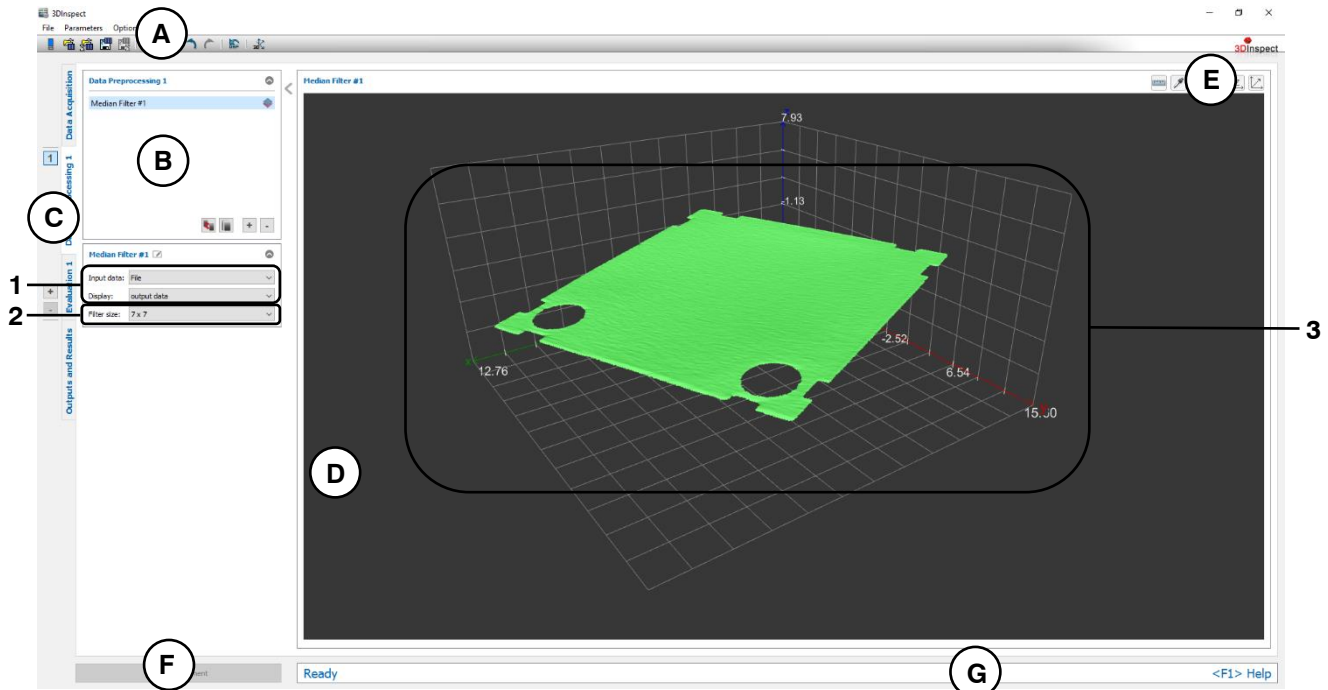

Fig. 5.14: "Median Filter" Measuring Program

Display Elements and Parameters in the "Median Filter" Program:

- A "General" toolbar:** Using this toolbar, you can select the data source (see Chapter 3.4 and 3.5), save and load parameters and reset selected parameters to default settings (see Chapter 3.20.3).
 - B List of active measuring programs:** This section displays the active measuring programs from the "Data preprocessing" group. You can add and remove measuring programs (see Chapter 3.15), move them (see Chapter 3.16) and select an active measuring program for parameterizing and displaying the measured values.
 - C Measuring program groups / Tab bar for switching between views:** This tab bar allows you to switch between the four main views (see Chapter 3.2). To the left of the tab bar you find the section for adding, removing and selecting measuring program groups (see Chapter 3.17).
 - D 3D-View:** The 3D-View visualizes the 3D data (see Chapter 3.11).
 - E "3D-View" toolbar:** Use this toolbar to configure the orientation of the coordinate system and activate various options for mouse interaction in the 3D-View (see Chapter 3.11).
 - F "Start measurement" button:** Click on this button to perform a measuring operation, calculate the measurement results and display the point cloud and measurement results of the currently selected measuring program in the 3D-View.
 - G Status bar:** Status and error messages are displayed in the status bar (see Chapter 8.1).
- 1 - **Input data:** Use this selection field to select the input data for the program (see also Chapter 3.18.3).
 - **Display:** Select whether input data, output data or both is displayed in the 3D-View.
 - 2 **Filter size:** Select the filter size of the median filter.
 - 3 **3D-View:** The filtered point cloud is shown in the 3D-View.

5.1.12 "Low Pass Filter" Measuring Program

Use the "Low Pass Filter" program to filter a point cloud using a Gaussian filter kernel. Structures with a wavelength greater than the predefined cut-off wavelength are preserved and components with shorter wavelengths are removed from the data. This makes it possible, in particular, to eliminate high-frequency and thus short-wave sensor noise. The size of the filter kernel is determined with the standard deviation calculated from the entered wavelength and the selected mode and is displayed in the "Kernel size" info box. The mode makes it possible to strike a balance between high execution speed and optimal filter behavior. The algorithm parameter can be used to select the direction in which the filter acts. The behavior at the border of the point cloud can be adjusted with the "Border mode" parameter. Proceed as follows:

- If applicable, select the input data for the low pass filter (see below, section "1" and Chapter 3.18.3).
- Select the algorithm, the cut-off wavelength, the mode and the border mode (see below, section "2").

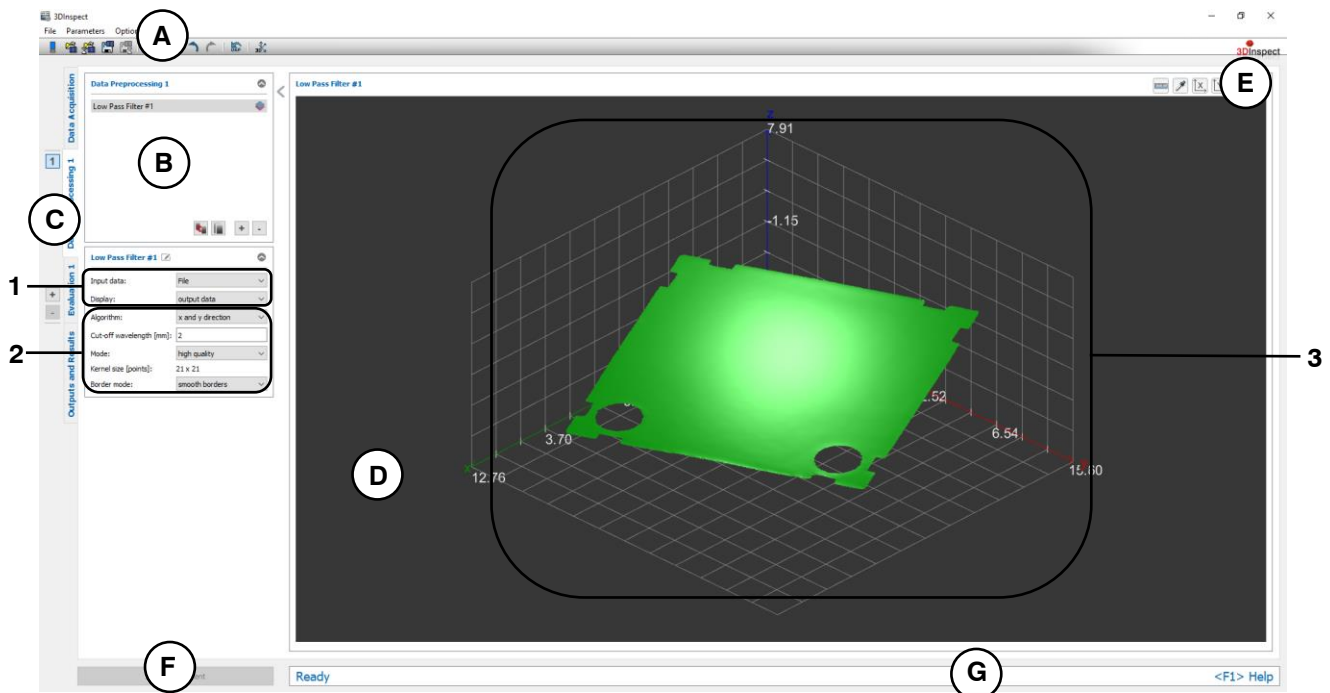

Fig. 5.15: "Low Pass Filter" Measuring Program

Display Elements and Parameters in the "Low Pass Filter" Program:

- A "General" toolbar:** Using this toolbar, you can select the data source (see Chapter 3.4 and 3.5), save and load parameters (see Chapter 3.20), reset selected parameters to default settings (see Chapter 3.20.3) and undo and restore changes of settings and parameters (see Chapter 3.21).
- B List of active measuring programs:** This section displays the active measuring programs from the "Data preprocessing" group. You can add and remove measuring programs (see Chapter 3.15), move them (see Chapter 3.16) and select an active measuring program for parameterizing and displaying the measured values.
- C Measuring program groups / Tab bar for switching between views:** This tab bar allows you to switch between the four main views (see Chapter 3.2). To the left of the tab bar you find the section for adding, removing and selecting measuring program groups (see Chapter 3.17).
- D 3D-View:** The 3D-View visualizes the 3D data (see Chapter 3.11).
- E "3D-View" toolbar:** Use this toolbar to configure the orientation of the coordinate system and activate various options for mouse interaction in the 3D-View (see Chapter 3.11).
- F "Start measurement" button:** Click on this button to perform a measuring operation, calculate the measurement results and display the point cloud and measurement results of the currently selected measuring program in the 3D-View.
- G Status bar:** Status and error messages are displayed in the status bar (see Chapter 8.1).

- 1
 - **Input data:** Use this selection field to select the input data for the program (see also Chapter 3.18.3).
 - **Display:** Select whether input data, output data or both is displayed in the 3D-View.
- 2
 - Algorithm:** Activate the filter and select the filter direction.
 - Cut-off wavelength [mm]:** Use this parameter to specify the cut-off wavelength.
 - Mode:** Use this parameter to define the confidence level:
 - **High Speed:** The confidence level is 90 %.
 - **Balanced:** The confidence level is 95 %.
 - **High Quality:** The confidence level is 99 %.
 - Kernel size:** In this section the resulting kernel is displayed, which is influenced by the "Cut-off wavelength" and the "Mode" parameter.
 - Border mode:** Use this parameter in order to adjust the behavior of the program at the border of the point cloud:
 - **Smooth borders:** The border points will also be filtered by extending the point cloud linearly at the borders about half of the filter size. This is done temporarily.
 - **Erode borders:** Border points will be removed.
- 3
 - 3D-View:** The filtered point cloud is shown in the 3D-View.

5.1.13 "High Pass Filter" Measuring Program

Use the "High Pass Filter" program in order to compute the difference of a point cloud which has been filtered with a low pass filter from the original point cloud. Structures with a wavelength smaller than the predefined cut-off wavelength are preserved and components with greater wavelengths are removed from the data. This makes it possible to bring out structures of point clouds. The size of the filter kernel is determined with the standard deviation calculated from the entered wavelength and the selected mode and is displayed in the "Kernel size" info box. The mode makes it possible to strike a balance between high execution speed and optimal filter behavior. The algorithm parameter can be used to select the direction in which the filter acts. The behavior at the border of the point cloud can be adjusted with the "Border mode" parameter. Proceed as follows:

- If applicable, select the input data for the high pass filter (see below, section "1" and Chapter 3.18.3).
- Select the algorithm, the cut-off wavelength, the mode and the border mode (see below, section "2").

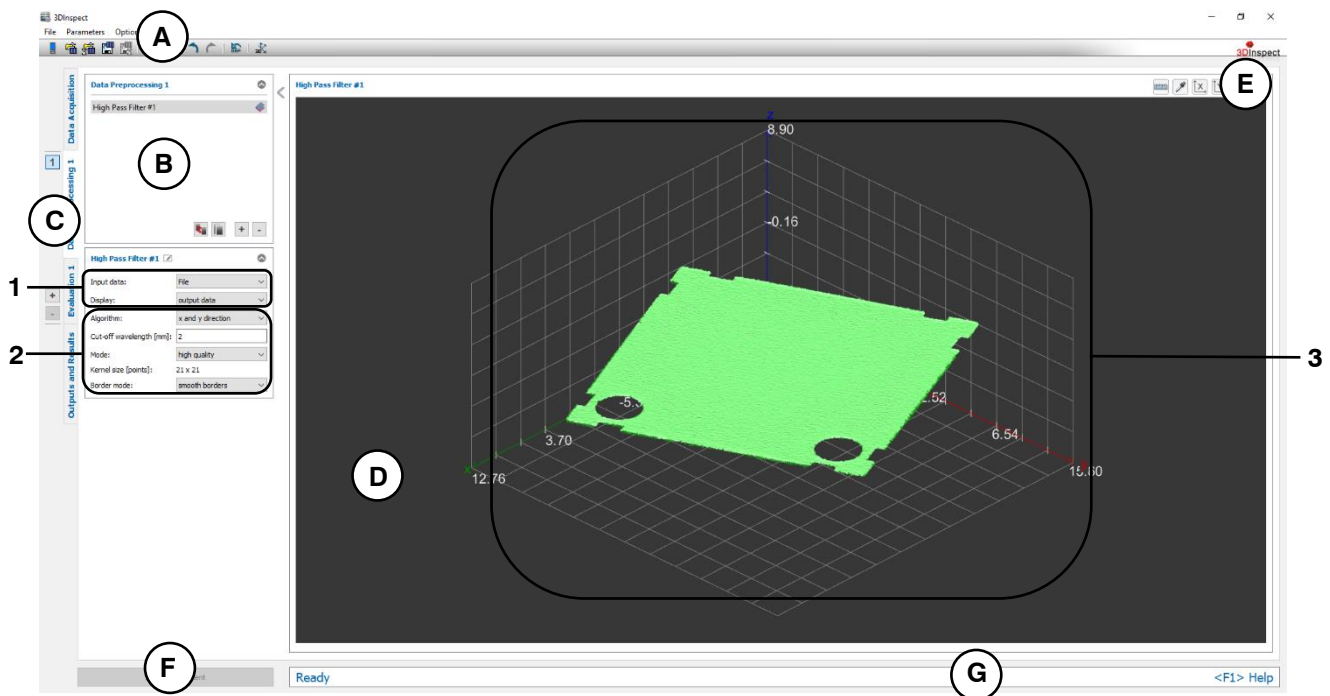

Fig. 5.16: "High Pass Filter" Measuring Program

Display Elements and Parameters in the "High Pass Filter" Program:

- A "General" toolbar:** Using this toolbar, you can select the data source (see Chapter 3.4 and 3.5), save and load parameters (see Chapter 3.20), reset selected parameters to default settings (see Chapter 3.20.3) and undo and restore changes of settings and parameters (see Chapter 3.21).
- B List of active measuring programs:** This section displays the active measuring programs from the "Data preprocessing" group. You can add and remove measuring programs (see Chapter 3.15), move them (see Chapter 3.16) and select an active measuring program for parameterizing and displaying the measured values.
- C Measuring program groups / Tab bar for switching between views:** This tab bar allows you to switch between the four main views (see Chapter 3.2). To the left of the tab bar you find the section for adding, removing and selecting measuring program groups (see Chapter 3.17).
- D 3D-View:** The 3D-View visualizes the 3D data (see Chapter 3.11).
- E "3D-View" toolbar:** Use this toolbar to configure the orientation of the coordinate system and activate various options for mouse interaction in the 3D-View (see Chapter 3.11).
- F "Start measurement" button:** Click on this button to perform a measuring operation, calculate the measurement results and display the point cloud and measurement results of the currently selected measuring program in the 3D-View.
- G Status bar:** Status and error messages are displayed in the status bar (see Chapter 8.1).

- 1
 - **Input data:** Use this selection field to select the input data for the program (see also Chapter 3.18.3).
 - **Display:** Select whether input data, output data or both is displayed in the 3D-View.
- 2
 - Algorithm:** Activate the filter and select the filter direction.
 - Cut-off wavelength [mm]:** Use this parameter to specify the cut-off wavelength.
 - Mode:** Use this parameter to define the confidence level:
 - **High Speed:** The confidence level is 90 %.
 - **Balanced:** The confidence level is 95 %.
 - **High Quality:** The confidence level is 99 %.
 - Kernel size:** In this section the resulting kernel is displayed, which is influenced by the "Cut-off wavelength" and the "Mode" parameter.
 - Border mode:** Use this parameter in order to adjust the behavior of the program at the border of the point cloud:
 - **Smooth borders:** The border points will also be filtered by extending the point cloud linearly at the borders about half of the filter size. This is done temporarily.
 - **Erode borders:** Border points will be removed.
- 3
 - 3D-View:** The filtered point cloud is shown in the 3D-View.

Note: The "High Pass Filter" program may create data which can't be processed by the "Closing", "Opening", "Low Pass Filter" and "High Pass Filter" programs. In this case a warning message is displayed below the measuring program settings. If you still want to use these programs, you must first resample the point cloud with the "Resample" measuring program (see Chapter 5.1.8).

5.1.14 "Closing" Measuring Program

Use the "Closing" program to fill small holes in a point cloud. Larger holes and the edge regions of the point cloud are retained and points within closed regions of the point cloud are not modified. You can use the "Filter size" parameter to alter the size of the closed holes. Use the "Shape" parameter to set the shape of the filled-in points.

Note: The "Closing" program requires an equidistant grid. Use the "Resampling" program (see Chapter 5.1.8) to create a point cloud with an equidistant grid when needed.

Proceed as follows:

- If applicable, select the input data for the closing program (see below, section "1" and Chapter 3.18.3).
- If necessary, select a range for the closing algorithm. Points which are outside the selected range will remain unchanged (see section "E" and Chapter 3.18.4, 3.18.6 and 3.18.7).
- Select the filter size (see below, section "2").

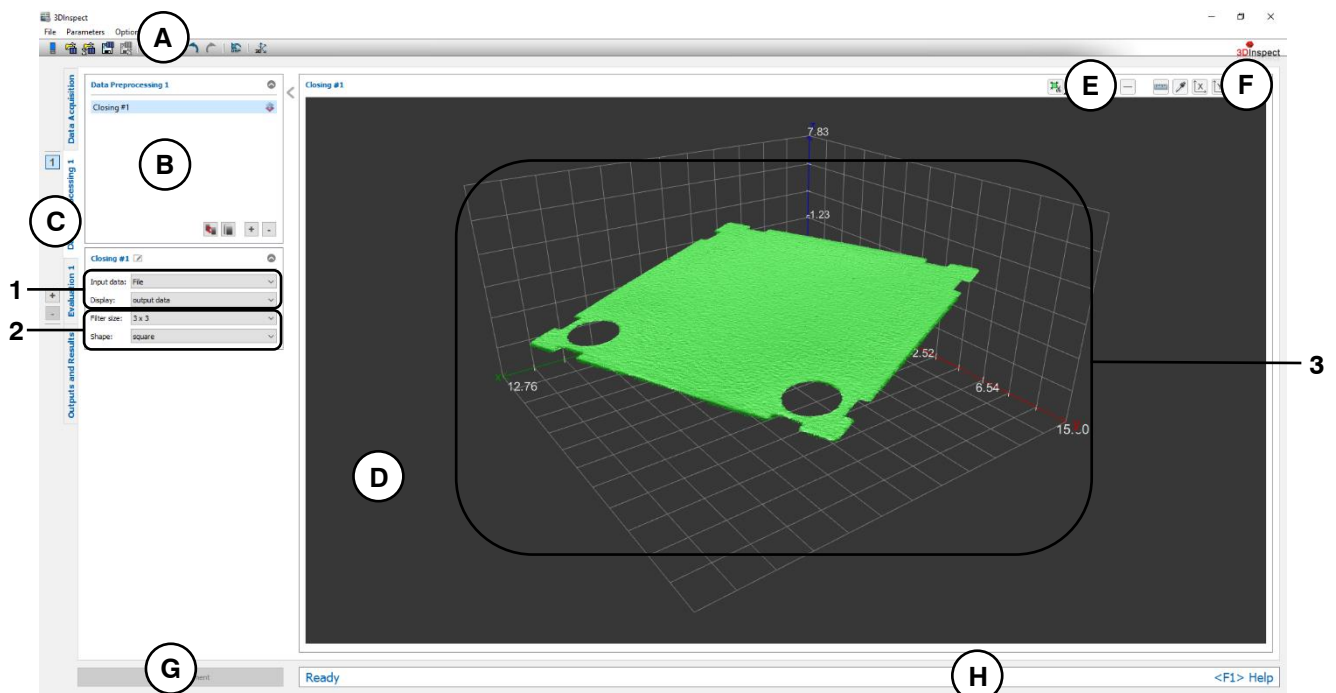

Fig. 5.17: "Closing" Measuring Program

Display Elements and Parameters in the "Closing" Program:

- A "General" toolbar:** Using this toolbar, you can select the data source (see Chapter 3.4 and 3.5), save and load parameters (see Chapter 3.20), reset selected parameters to default settings (see Chapter 3.20.3) and undo and restore changes of settings and parameters (see Chapter 3.21).
- B List of active measuring programs:** This section displays the active measuring programs from the "Data preprocessing" group. You can add and remove measuring programs (see Chapter 3.15), move them (see Chapter 3.16) and select an active measuring program for parameterizing and displaying the measured values.
- C Measuring program groups / Tab bar for switching between views:** This tab bar allows you to switch between the four main views (see Chapter 3.2). To the left of the tab bar you find the section for adding, removing and selecting measuring program groups (see Chapter 3.17).
- D 3D-View:** The 3D-View visualizes the 3D data (see Chapter 3.11).
- E "Measuring" toolbar:** Use this toolbar to set various ROIs for the measurement (see Chapter 3.18.4, 3.18.6 and 3.18.7).
- F "3D-View" toolbar:** Use this toolbar to configure the orientation of the coordinate system and activate various options for mouse interaction in the 3D-View (see Chapter 3.11).

- G** **"Start measurement" button:** Click on this button to perform a measuring operation, calculate the measurement results and display the point cloud and measurement results of the currently selected measuring program in the 3D-View.
- H** **Status bar:** Status and error messages are displayed in the status bar (see Chapter 8.1).
- 1** - **Input data:** Use this selection field to select the input data for the program (see also Chapter 3.18.3).
 - **Display:** Select whether input data, output data or both is displayed in the 3D-View.
- 2** - **Filter size:** Select the size of the structure mask.
 - **Shape:** Select the shape of the structure mask (square or circle).
- 3** **3D-View:** The filled-in point cloud is shown in the 3D-View.

5.1.15 "Erosion" Measuring Program

The "Erosion" program makes it possible to remove unwanted points in the edge regions of a point cloud. The "Filter size" parameter specifies the size of the centered quadratic or circular element used for the erosion. The larger the element, the more points are removed. Points within closed regions of the point cloud are not changed. The "Shape" parameter specifies the shape of the erosion mask. Proceed as follows:

- If applicable, select the input data for the erosion (see below, section "1" and Chapter 3.18.3).
- If necessary, select a range for the erosion algorithm. Points which are outside the selected range will remain unchanged (see section "E" and Chapter 3.18.4, 3.18.6 and 3.18.7).
- Select the filter size (see below, section "2").

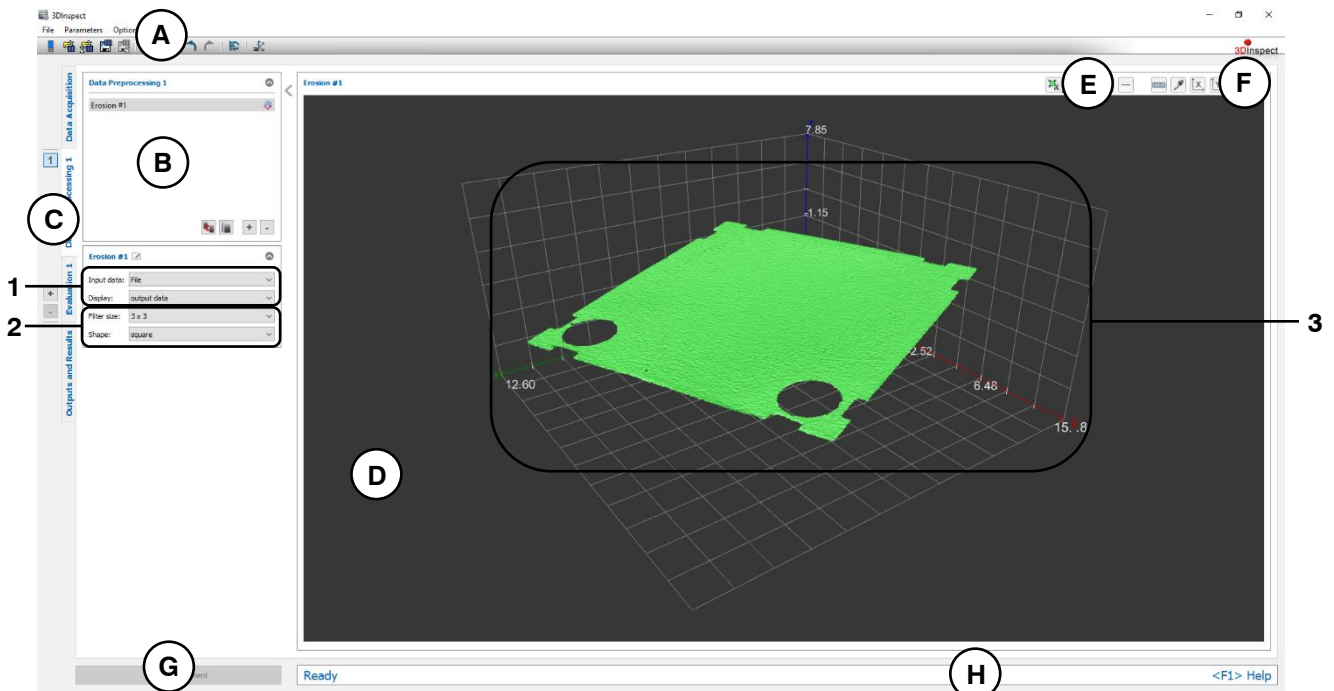

Fig. 5.18: "Erosion" Measuring Program

Display Elements and Parameters in the "Erosion" Program:

- A "General" toolbar:** Using this toolbar, you can select the data source (see Chapter 3.4 and 3.5), save and load parameters (see Chapter 3.20), reset selected parameters to default settings (see Chapter 3.20.3) and undo and restore changes of settings and parameters (see Chapter 3.21).
- B List of active measuring programs:** This section displays the active measuring programs from the "Data preprocessing" group. You can add and remove measuring programs (see Chapter 3.15), move them (see Chapter 3.16) and select an active measuring program for parameterizing and displaying the measured values.
- C Measuring program groups / Tab bar for switching between views:** This tab bar allows you to switch between the four main views (see Chapter 3.2). To the left of the tab bar you find the section for adding, removing and selecting measuring program groups (see Chapter 3.17).
- D 3D-View:** The 3D-View visualizes the 3D data (see Chapter 3.11).
- E "Measuring" toolbar:** Use this toolbar to set various ROIs for the measurement (see Chapter 3.18.4, 3.18.6 and 3.18.7).
- F "3D-View" toolbar:** Use this toolbar to configure the orientation of the coordinate system and activate various options for mouse interaction in the 3D-View (see Chapter 3.11).
- G "Start measurement" button:** Click on this button to perform a measuring operation, calculate the measurement results and display the point cloud and measurement results of the currently selected measuring program in the 3D-View.
- H Status bar:** Status and error messages are displayed in the status bar (see Chapter 8.1).

- 1
 - **Input data:** Use this selection field to select the input data for the program (see also Chapter [3.18.3](#)).
 - **Display:** Select whether input data, output data or both is displayed in the 3D-View.
- 2
 - **Filter size:** Select the size of the structure mask.
 - **Shape:** Select the shape of the erosion mask (square or circle).
- 3 **3D-View:** The eroded point cloud is shown in the 3D-View.

5.1.16 "Opening" Measuring Program

Use the "Opening" program to enlarge small holes in a point cloud. Small holes and the edge regions of the point cloud are retained and points within closed regions of the point cloud are not modified. You can use the "Filter size" parameter to alter the size of the enlarged holes. Use the "Shape" parameter to set the shape of the removed points.

Note: The "Opening" program requires an equidistant grid. Use the "Resampling" program (see Chapter 5.1.8) to create a point cloud with an equidistant grid when needed.

Proceed as follows:

- If applicable, select the input data for the opening (see below, section "1" and Chapter 3.18.3).
- If necessary, select a range for the opening algorithm. Points which are outside the selected range will remain unchanged (see section "E" and Chapter 3.18.4, 3.18.6 and 3.18.7).
- Select the filter size (see below, section "2").

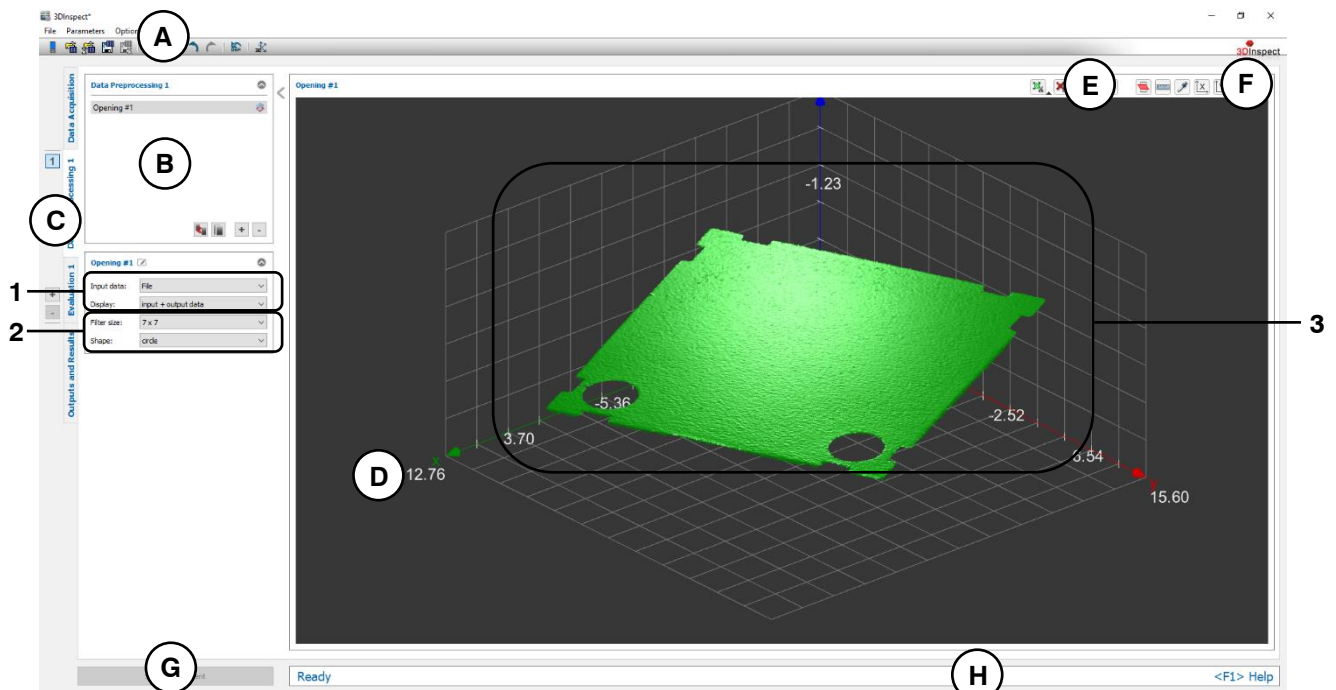

Fig. 5.19: "Opening" Measuring Program

Display Elements and Parameters in the "Opening" Program:

- A "General" toolbar:** Using this toolbar, you can select the data source (see Chapter 3.4 and 3.5), save and load parameters (see Chapter 3.20), reset selected parameters to default settings (see Chapter 3.20.3) and undo and restore changes of settings and parameters (see Chapter 3.21).
- B List of active measuring programs:** This section displays the active measuring programs from the "Data preprocessing" group. You can add and remove measuring programs (see Chapter 3.15), move them (see Chapter 3.16) and select an active measuring program for parameterizing and displaying the measured values.
- C Measuring program groups / Tab bar for switching between views:** This tab bar allows you to switch between the four main views (see Chapter 3.2). To the left of the tab bar you find the section for adding, removing and selecting measuring program groups (see Chapter 3.17).
- D 3D-View:** The 3D-View visualizes the 3D data (see Chapter 3.11).
- E "Measuring" toolbar:** Use this toolbar to set various ROIs for the measurement (see Chapter 3.18.4, 3.18.6 and 3.18.7).
- F "3D-View" toolbar:** Use this toolbar to configure the orientation of the coordinate system and activate various options for mouse interaction in the 3D-View (see Chapter 3.11).

- G** **"Start measurement" button:** Click on this button to perform a measuring operation, calculate the measurement results and display the point cloud and measurement results of the currently selected measuring program in the 3D-View.
- H** **Status bar:** Status and error messages are displayed in the status bar (see Chapter 8.1).
- 1** - **Input data:** Use this selection field to select the input data for the program (see also Chapter 3.18.3).
- **Display:** Select whether input data, output data or both is displayed in the 3D-View.
- 2** - **Filter size:** Select the size of the structure mask.
- **Shape:** Select the shape of the structure mask (square or circle).
- 3** **3D-View:** The resulting point cloud is shown in the 3D-View.

5.1.17 "Remove points" Measuring Program

The "Remove points" program allows to remove unwanted points. The "Mode" parameter specifies the algorithm by which the points to be removed are selected. In the "Isolated points" mode, the "Min. number of neighbors" parameter specifies the minimum number of valid neighboring points that a point or one of its eight neighboring points must have in order not to be removed. In the "Percentage" mode, a percentage of the respective value range from which the points are removed can be specified on both sides in a specified direction. Proceed as follows:

- If applicable, select the input data for the program (see below, section "1" and Chapter 3.18.3).
- If necessary, select a range from which the points are to be removed. Points which are outside the selected range will remain unchanged (see section "E" and Chapter 3.18.4, 3.18.6 and 3.18.7).
- Select the mode and set the correspondent parameters for removing the points (see below, section "2").

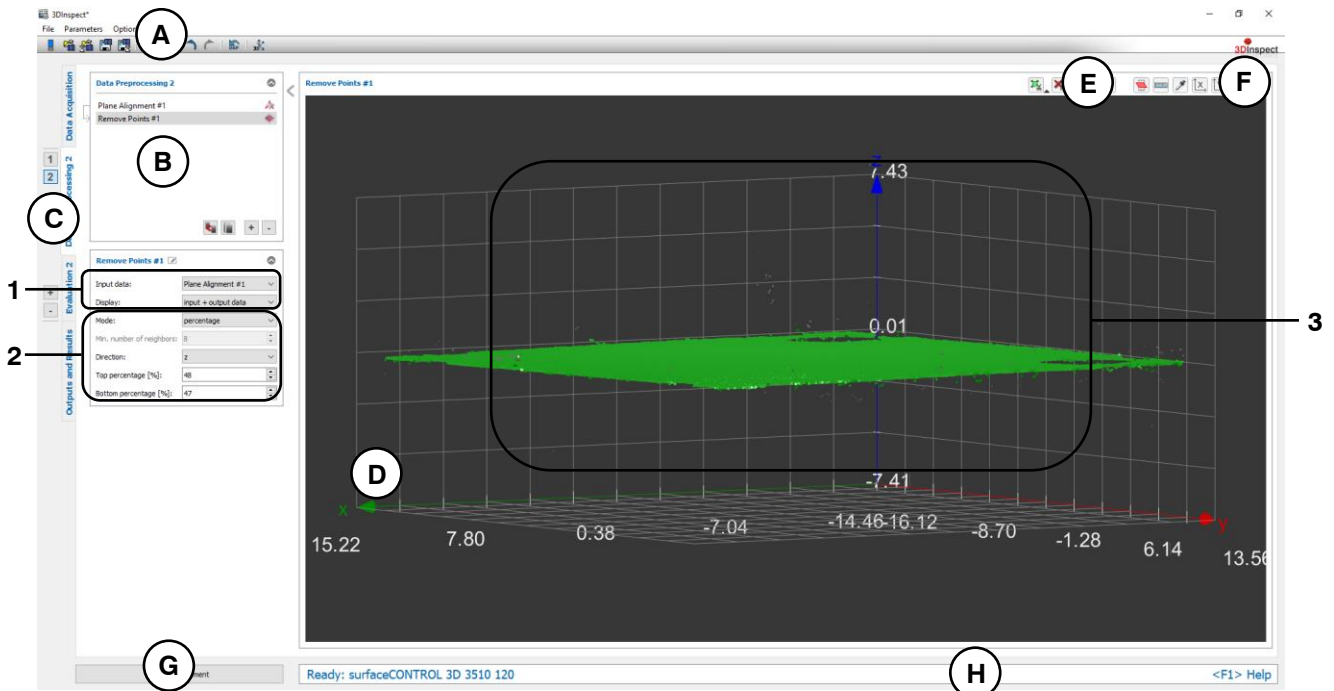

Fig. 5.20: "Remove Points" Measuring Program

Display Elements and Parameters in the "Remove Points" Program:

- A "General" toolbar:** Using this toolbar, you can select the data source (see Chapter 3.4 and 3.5), save and load parameters (see Chapter 3.20), reset selected parameters to default settings (see Chapter 3.20.3) and undo and restore changes of settings and parameters (see Chapter 3.21).
- B List of active measuring programs:** This section displays the active measuring programs from the "Data preprocessing" group. You can add and remove measuring programs (see Chapter 3.15), move them (see Chapter 3.16) and select an active measuring program for parameterizing and displaying the measured values.
- C Measuring program groups / Tab bar for switching between views:** This tab bar allows you to switch between the four main views (see Chapter 3.2). To the left of the tab bar you find the section for adding, removing and selecting measuring program groups (see Chapter 3.17).
- D 3D-View:** The 3D-View visualizes the 3D data (see Chapter 3.11).
- E "Measuring" toolbar:** Use this toolbar to set various ROIs for the measurement (see Chapter 3.18.4, 3.18.6 and 3.18.7).
- F "3D-View" toolbar:** Use this toolbar to configure the orientation of the coordinate system and activate various options for mouse interaction in the 3D-View (see Chapter 3.11).
- G "Start measurement" button:** Click on this button to perform a measuring operation, calculate the measurement results and display the point cloud and measurement results of the currently selected measuring program in the 3D-View.

- H Status bar:** Status and error messages are displayed in the status bar (see Chapter 8.1).

- 1**
 - **Input data:** Use this selection field to select the input data for the program (see also Chapter 3.18.3).
 - **Display:** Select whether input data, output data or both is displayed in the 3D-View.

- 2 Mode:** Select the mode for removing the points:
 - **Isolated points:** For each point the algorithm checks whether the number of neighbors is smaller than the set value. If the condition is met for a point and its eight neighboring points, the point is removed.
 - **Min. number of neighbors:** Enter the minimum number of valid neighboring points.
 - **Percentage:** All points are removed from a percentage of the range of values in the specified direction.
 - **Direction:** Choose the direction for removing the points.
 - **Top percentage [%]:** Specify the percentage of the value range in the positive direction from which the points are removed.
 - **Bottom percentage [%]:** Specify the percentage of the value range in the negative direction from which the points are removed.

- 3 3D-View:** The 3D-View shows the input point cloud (gray) and the resulting point cloud (green).

5.1.18 "Wave Compensation" Measuring Program

Use the "Wave Compensation" program in order to compensate vibrations in y direction. This is particularly useful when using the scanCONTROL 30XX sensor type. A reference line parallel to the X-axis is fitted line by line and subtracted from the point cloud. Then the point cloud will be translated so that the selectable rotation point is equal to the center of the coordinate system. Proceed as follows:

- First, if you have not already, activate the "Evaluation" view (see Chapter 6), insert a measuring program with a point as output value (e.g. "Center of Gravity", see Chapter 6.1.1) and configure this measuring program in order to obtain a rotation point.
- Now, create a new program group (see Chapter 3.17) and insert the "Wave Compensation" program in the "Data preprocessing" section.
- If applicable, select the input data for the program (see below, section "1" and Chapter 3.18.3).
- Select the ranges for the points to which the reference lines are to be fitted line by line (see below, section "E" and Chapter 3.18.4, 3.18.6 and 3.18.7). Points which are outside the selected ranges in y direction will remain unchanged.

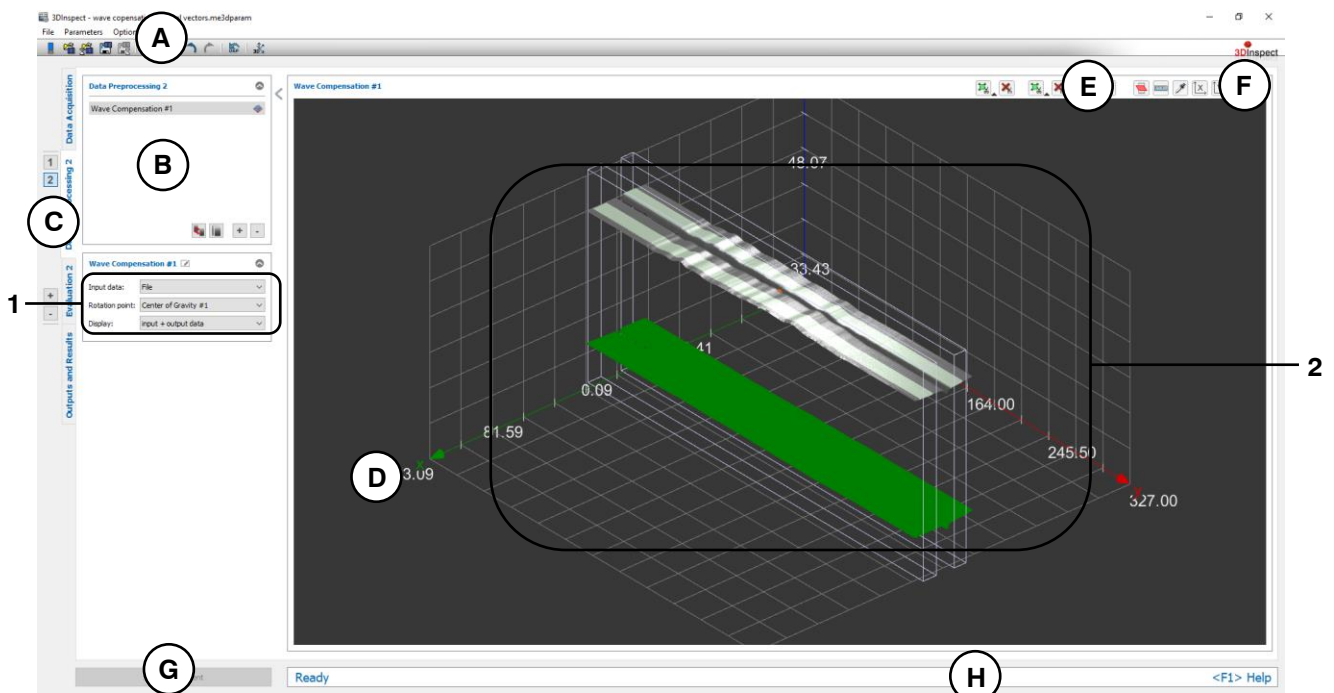

Fig. 5.21: "Wave Compensation" Measuring Program

Display Elements and Parameters in the "Wave Compensation" Program:

- A "General" toolbar:** Using this toolbar, you can select the data source (see Chapter 3.4 and 3.5), save and load parameters (see Chapter 3.20), reset selected parameters to default settings (see Chapter 3.20.3) and undo and restore changes of settings and parameters (see Chapter 3.21).
- B List of active measuring programs:** This section displays the active measuring programs from the "Data preprocessing" group. You can add and remove measuring programs (see Chapter 3.15), move them (see Chapter 3.16) and select an active measuring program for parameterizing and displaying the measured values.
- C Measuring program groups / Tab bar for switching between views:** This tab bar allows you to switch between the four main views (see Chapter 3.2). To the left of the tab bar you find the section for adding, removing and selecting measuring program groups (see Chapter 3.17).
- D 3D-View:** The 3D-View visualizes the 3D data (see Chapter 3.11).
- E "Measuring" toolbar:** Use this toolbar to set various ROIs for the measurement (see Chapter 3.18.4, 3.18.6 and 3.18.7).
- F "3D-View" toolbar:** Use this toolbar to configure the orientation of the coordinate system and activate various options for mouse interaction in the 3D-View (see Chapter 3.11).

- G** **"Start measurement" button:** Click on this button to perform a measuring operation, calculate the measurement results and display the point cloud and measurement results of the currently selected measuring program in the 3D-View.
- H** **Status bar:** Status and error messages are displayed in the status bar (see Chapter 8.1).

- 1** - **Input data:** Use this selection field to select the input data and the rotation point for the program (see also Chapter 3.18.3).
 - **Display:** Select whether input data, output data or both is displayed in the 3D-View.
- 2** **3D-View:** The 3D-View shows the input point cloud (gray) and the resulting point cloud (green).

5.1.19 "Profile Section" Measuring Program

The "Profile Section" program generates a 2D profile from a 3D point cloud, which can be processed by subsequent 2D-measuring programs. The parameter "Plane angle" defines the angle between the cutting plane and the xz plane and the parameter "Plane offset" defines the distance between the cutting plane and the z axis. If the "Reset values" button is pressed, the angle is set to 0 and the plane is centered in the middle of the point cloud. Proceed as follows:

- If applicable, select the input data for the profile selection (see below, section "1" and Chapter 3.18.3).
- Use the "reset values" button, if the cutting plane is not visible.
- Change the "plane angle" and the "plane offset" to select the desired 2D profile (see below, section "2") or configure the cutting plane via mouse interaction.

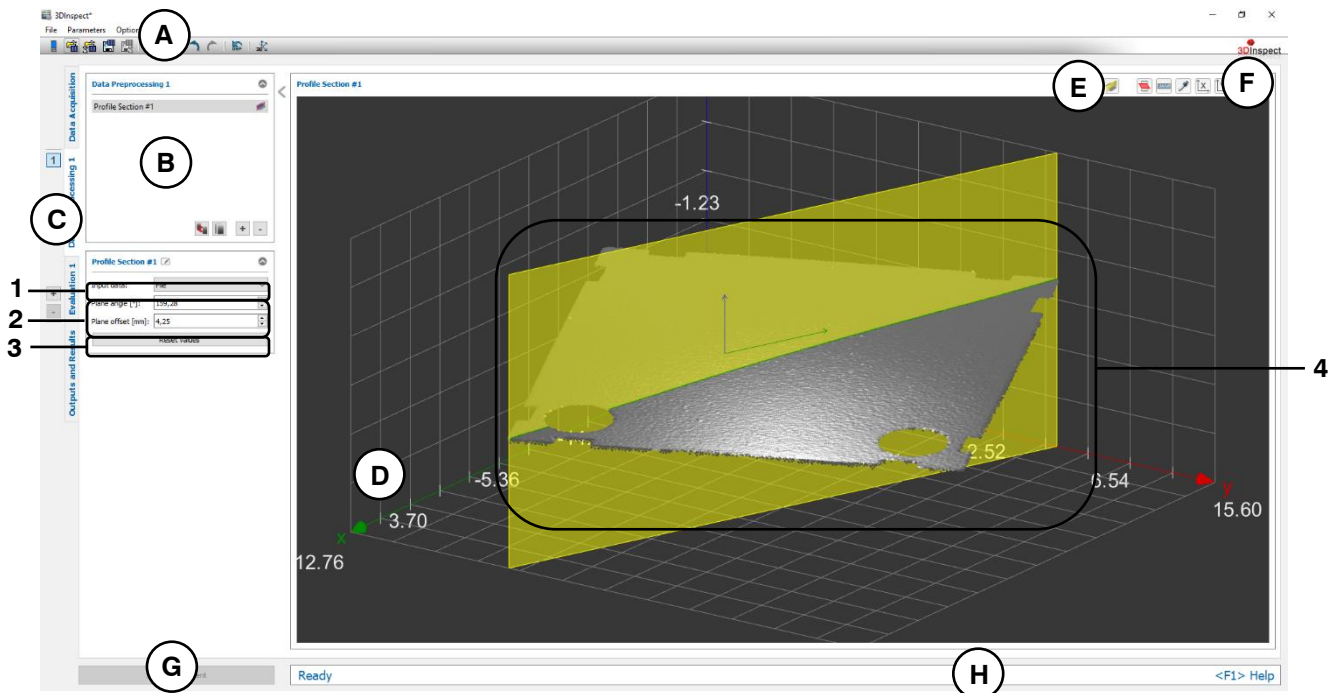

Fig. 5.22: "Profile Section" Measuring Program

Display Elements and Parameters in the "Profile Section" Program:

- A "General" toolbar:** Using this toolbar, you can select the data source (see Chapter 3.4 and 3.5), save and load parameters (see Chapter 3.20), reset selected parameters to default settings (see Chapter 3.20.3) and undo and restore changes of settings and parameters (see Chapter 3.21).
- B List of active measuring programs:** This section displays the active measuring programs from the "Data preprocessing" group. You can add and remove measuring programs (see Chapter 3.15), move them (see Chapter 3.16) and select an active measuring program for parameterizing and displaying the measured values.
- C Measuring program groups / Tab bar for switching between views:** This tab bar allows you to switch between the four main views (see Chapter 3.2). To the left of the tab bar you find the section for adding, removing and selecting measuring program groups (see Chapter 3.17).
- D 3D-View:** The 3D-View visualizes the 3D data (see Chapter 3.11).
- E "Measuring" toolbar:** Use this toolbar to select the cutting plane and change the parameters via mouse interaction. Use the left mouse button to move the plane and the shift and left mouse button to rotate the plane around the z axis.
- F "3D-View" toolbar:** Use this toolbar to configure the orientation of the coordinate system and activate various options for mouse interaction in the 3D-View (see Chapter 3.11).
- G "Start measurement" button:** Click on this button to perform a measuring operation, calculate the measurement results and display the point cloud and measurement results of the currently selected measuring program in the 3D-View.

- H** **Status bar:** Status and error messages are displayed in the status bar (see Chapter [8.1](#)).

- 1** **Input data:** Use this selection field to select the input data for the program (see also Chapter [3.18.3](#)).
- 2** - **Plane angle:** Change the angle between the intersection plane and the xz plane.
 - **Plane offset:** Change the offset from the intersection plane to the z axis
- 3** **Reset values:** Reset the parameter "Plane angle" to 0 and "Plane offset" to the middle of the point cloud.
- 4** **3D-View:** In the 3D-View, the input point cloud (gray), the cutting plane (yellow) and the 2D profile (green) are displayed. In addition, the resulting coordinate system is displayed in the cutting plane.

5.1.20 "Position Correction 2D" Measuring Program

Use the "Position Correction 2D" program to correct tilting and displacements caused by the mounting position of the sensor. You can rotate and move the 2D profile and store the resulting correction of the 2D points permanently in the measuring program. You can manually edit the values for the correction or automatically determine the correction values using a line fit. By this the values are determined such that the fitted line lies horizontally in the coordinate system and the center of gravity of the fitted points is at the center of the coordinate system.

Note: The "Position Correction 2D" program needs a 2D profile as input data. The "Profile Section" measuring program can be used in order to generate a 2D profile. (see Chapter 5.1.19)

Proceed as follows:

- If applicable, select the input data for the position correction (see below, section "1" and Chapter 3.18.3).
- Manually entry of values:
 - Enter the desired values for the rotation and translation (see below, section "2")
- Automatic determination of values:
 - Activate the setup mode of the measuring program (see below, section "4"). A line is then fitted to the 2D points of the 2D profile.
 - If necessary, limit the range for the line fit in order to eliminate interfering points (see section "E" and Chapter 3.18.5, 3.18.6 and 3.18.7).
 - Click on the "Calculate values" button (see below, section "5"). The profile is aligned such that the fitted line lies horizontally in the coordinate system and the center of gravity of the fitted points is at the center of the coordinate system.
 - Deactivate the setup mode (see below, section "4").

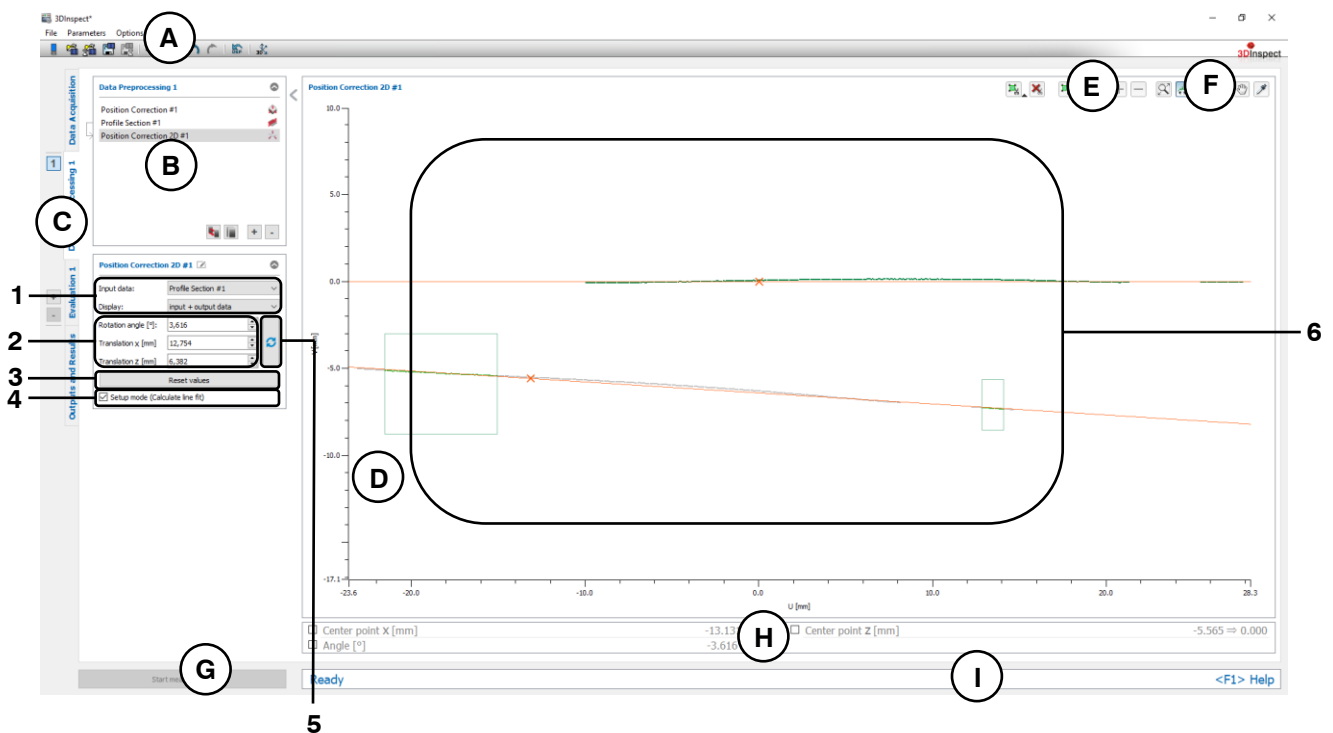

Fig. 5.23: "Position Correction 2D" Measuring Program

Display Elements and Parameters in the "Position Correction 2D" Program:

- A** **"General" toolbar:** Using this toolbar, you can select the data source (see Chapter 3.4 and 3.5), save and load parameters (see Chapter 3.20), reset selected parameters to default settings (see Chapter 3.20.3) and undo and restore changes of settings and parameters (see Chapter 3.21).
 - B** **List of active measuring programs:** This section displays the active measuring programs from the "Data preprocessing" group. You can add and remove measuring programs (see Chapter 3.15), move them (see Chapter 3.16) and select an active measuring program for parameterizing and displaying the measured values.
 - C** **Measuring program groups / Tab bar for switching between views:** This tab bar allows you to switch between the four main views (see Chapter 3.2). To the left of the tab bar you find the section for adding, removing and selecting measuring program groups (see Chapter 3.17).
 - D** **2D Profile View:** The 2D Profile View visualizes the 2D data (see Chapter 3.13).
 - E** **"Measuring" toolbar:** Use this toolbar to set various ROIs for the measurement (see Chapter 3.18.5, 3.18.6 and 3.18.7).
 - F** **"2D Profile View" toolbar:** Use this toolbar to scale the 2D Profile View and activate various options for mouse interaction (see Chapter 3.13).
 - G** **"Start measurement" button:** Click on this button to perform a measuring operation, calculate the measurement results and display the profile and measurement results of the currently selected measuring program in the 2D Profile View.
 - H** **Results display:** In setup mode, the characteristic data of the original line and of the transformed line are displayed.
 - I** **Status bar:** Status and error messages are displayed in the status bar (see Chapter 8.1).
- 1**
 - **Input data:** Use this selection field to select the input data for the program (see also Chapter 3.18.3).
 - **Display:** Select whether input data, output data or both is displayed in the 2D Profile View (This selection is not available if setup mode is active).
 - 2** **2D Transformation settings:**
 - **Rotation angle [°]:** The angle about which the profile is rotated. The origin of the coordinate system is used as center of rotation.
 - **Translation x/z [mm]:** The offset by which the profile is moved in the relevant direction.
 - 3** **Reset values:** Resets the "Rotation angle" and "Translation x/z" values to zero.
 - 4** **Setup mode:** This option field allows you to activate or deactivate setup mode.
 - 5** **Calculate values:** In setup mode, click on this button to calculate the angle and offset such that the fitted line lies horizontally in the coordinate system and the center of gravity of the fitted points is at the center of the coordinate system.
 - 6** **2D Profile View:** In the 2D Profile View, the input profile (gray) and the transformed profile (green) are displayed. In setup mode, the original and the transformed line and, if applicable, the ROIs are also displayed.

Note: The position correction is performed as follows: first, the rotation around the origin of the coordinate system, then the movement of the profile.

5.1.21 "Select Points 2D" Measuring Program

Use the "Select Points 2D" program to select 2D points from the ROIs and to discard the remaining points. This can be useful if, for example, parts of the holder or support surface of the measured object are within the measuring field or in the event of reflections not produced by the measured object. You can use up to four ROIs. For each ROI, you can select whether the points inside or outside the ROI should be discarded. Discarded points are shown in gray, and selected points are shown in green and can be used as input data in subsequent measuring programs.

Note: The "Select Points 2D" program needs a 2D profile as input data. The "Profile Section" measuring program can be used in order to generate a 2D profile. (see Chapter 5.1.19)

Proceed as follows:

- If applicable, select the input data for the program (see below, section "1" and Chapter 3.18.3).
- Set the parameters for the ROIs in order to eliminate interfering points (see below, section "E" and Chapter 3.18.5, 3.18.6 and 3.18.7).

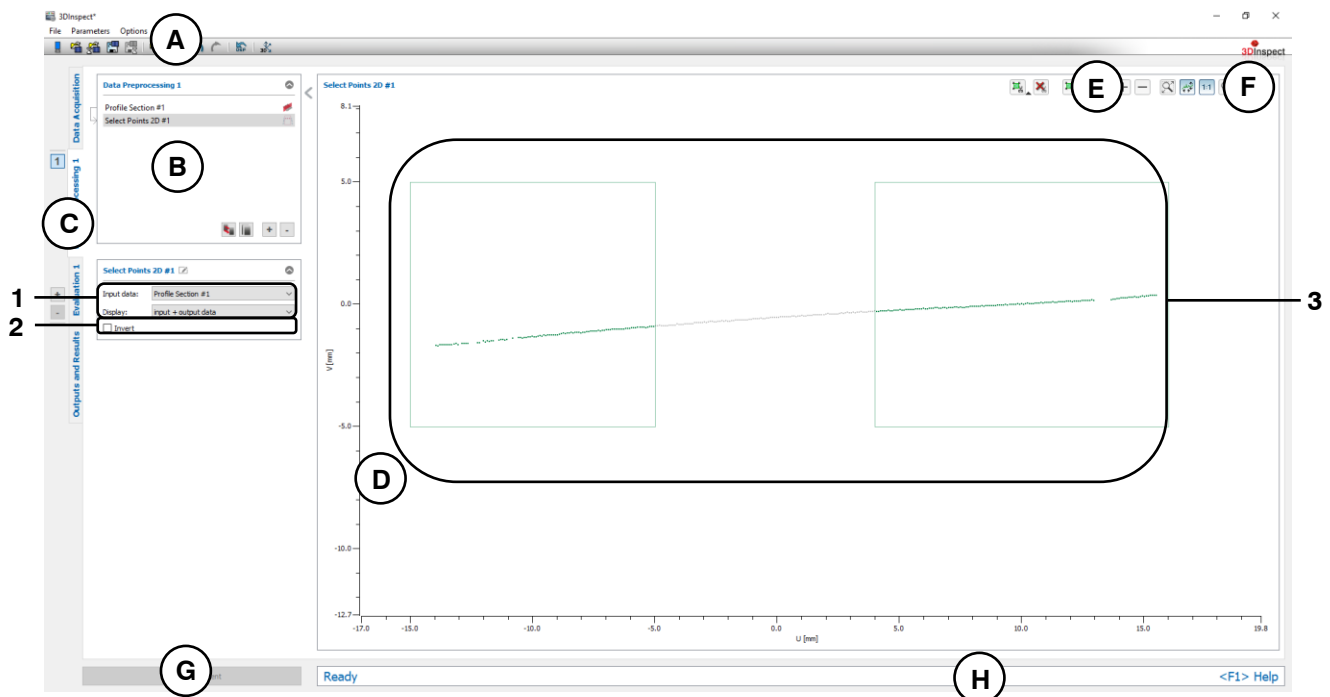

Fig. 5.24: "Select Points 2D" Measuring Program

Display Elements and Parameters in the "Select Points 2D" Program:

- A "General" toolbar:** Using this toolbar, you can select the data source (see Chapter 3.4 and 3.5), save and load parameters (see Chapter 3.20), reset selected parameters to default settings (see Chapter 3.20.3) and undo and restore changes of settings and parameters (see Chapter 3.21).
- B List of active measuring programs:** This section displays the active measuring programs from the "Data preprocessing" group. You can add and remove measuring programs (see Chapter 3.15), move them (see Chapter 3.16) and select an active measuring program for parameterizing and displaying the measured values.
- C Measuring program groups / Tab bar for switching between views:** This tab bar allows you to switch between the four main views (see Chapter 3.2). To the left of the tab bar you find the section for adding, removing and selecting measuring program groups (see Chapter 3.17).
- D 2D Profile View:** The 2D Profile View visualizes the 2D data (see Chapter 3.13).
- E "Measuring" toolbar:** Use this toolbar to set the ROIs (see Chapter 3.18.5, 3.18.6 and 3.18.7).
- F "2D Profile View" toolbar:** Use this toolbar to scale the 2D Profile View and activate various options for mouse interaction (see Chapter 3.13).

- G** **"Start measurement" button:** Click on this button to perform a measuring operation, calculate the measurement results and display the profile and measurement results of the currently selected measuring program in the 2D Profile View.
- H** **Status bar:** Status and error messages are displayed in the status bar (see Chapter 8.1).
- 1**
 - **Input data:** Use this selection field to select the input data for the program (see also Chapter 3.18.3).
 - **Display:** Select whether input data, output data or both is displayed in the 2D Profile View.
- 2** **Invert:** Check this box to invert the selection of points.
- 3** **2D Profile View:** In the 2D Profile View, the discarded points (gray) and the selected points (green) are displayed.

5.1.22 "Line Alignment 2D" Measuring Program

Use the "Line Alignment 2D" program to align a 2D profile to a 2D line. This step allows to compensate for changes to the pitch of the object in different measurements. Therefore, ROIs that are used in subsequent measuring programs are not affected by the pitch changes and can be used at defined positions relative to the object.

Note: The "Line Alignment 2D" program needs a 2D profile as input data. The "Profile Section" measuring program can be used in order to generate a 2D profile. (see Chapter 5.1.19)

The object is rotated about a selectable rotation point so that the reference line is parallel to the x axis. Additionally, the position of the object may be compensated. By this the object will be translated so that the rotation point is equal to the center of the coordinate system.

Note: In addition to the input profile, the "Line Alignment 2D" measuring program requires a 2D line and a rotation point as input data. These objects have to be computed with the "Line fit 2D" measuring program (see Chapter 6.1.17) which has to be in a previous program group. Alternatively you may use another measuring program for computation of the rotation point (see below, Section 1).

Proceed as follows:

- First, if you have not already, activate the "Evaluation" view (see Chapter 6), insert the "Line fit 2D" measuring program and configure the measuring program in order to obtain a 2D line and a rotation point (see Chapter 6.1.17). Alternatively you may use another measuring program for computation of the rotation point (see below, Section 1).
- Now, create a new program group (see Chapter 3.17) and insert the "Line Alignment 2D" program in the "Data preprocessing" section.
- Select the input 2D profile, the reference line and the rotation point for the program (see below, section "1" and Chapter 3.18.3).
- If required, activate the position correction of the object in addition to the pitch correction (see below, section "2").

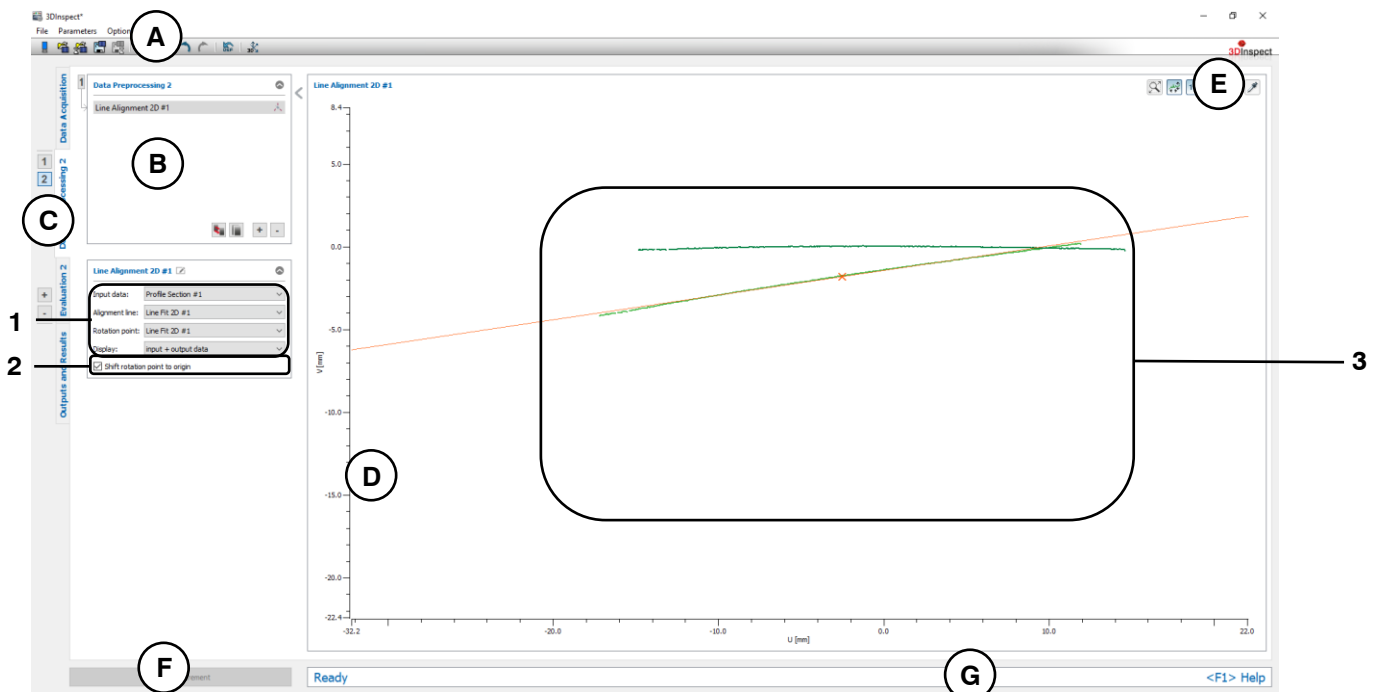

Fig. 5.25: "Line Alignment 2D" Measuring Program

Display Elements and Parameters in the "Line Alignment 2D" Program:

- A "General" toolbar:** Using this toolbar, you can select the data source (see Chapter 3.4 and 3.5), save and load parameters (see Chapter 3.20), reset selected parameters to default settings (see Chapter 3.20.3) and undo and restore changes of settings and parameters (see Chapter 3.21).
 - B List of active measuring programs:** This section displays the active measuring programs from the "Data preprocessing" group. You can add and remove measuring programs (see Chapter 3.15), move them (see Chapter 3.16) and select an active measuring program for parameterizing and displaying the measured values.
 - C Measuring program groups / Tab bar for switching between views:** This tab bar allows you to switch between the four main views (see Chapter 3.2). To the left of the tab bar you find the section for adding, removing and selecting measuring program groups (see Chapter 3.17).
 - D 2D Profile View:** The 2D Profile View visualizes the 2D data (see Chapter 3.13).
 - E "2D Profile View" toolbar:** Use this toolbar to scale the 2D Profile View and activate various options for mouse interaction (see Chapter 3.13).
 - F "Start measurement" button:** Click on this button to perform a measuring operation, calculate the measurement results and display the profile and measurement results of the currently selected measuring program in the 2D Profile View.
 - G Status bar:** Status and error messages are displayed in the status bar (see Chapter 8.1).
-
- 1**
 - **Input data:** Use this selection field to select the input data, the reference line and the rotation point for the program (see also Chapter 3.18.3). An overview of measuring programs, which provide 2D points and 2D lines, can be found in Chapter 3.19.1 and 3.19.2
 - **Display:** Select whether input data, output data or both is displayed in the 2D Profile View.
 - 2 Shift rotation point to origin:** You may activate the position correction of the object in addition to the pitch correction here.
 - 3 2D Profile View:** The 2D Profile View shows the input profile (light green), the reference line (orange), the rotation point (orange) and the aligned profile (green).

5.1.23 "Point Alignment 2D" Measuring Program

Use the "Point Alignment 2D" program to align a 2D profile to a 2D point. This step allows to compensate for changes to the position of the object in different measurements. Therefore, ROIs that are used in subsequent measuring programs are not affected by the position changes and can be used at defined positions relative to the object.

Note: The "Point Alignment 2D" program needs a 2D profile as input data. The "Profile Section" measuring program can be used in order to generate a 2D profile. (see Chapter 5.1.19)

The object is aligned on a selectable point so that the alignment point becomes the origin of the coordinate system.

Note: In addition to the input profile, the "Point Alignment 2D" measuring program requires an alignment point as input data. This point has to be computed with a measuring program which provides a 2D point and which has to be in a previous program group (e.g. "Center of Gravity 2D", see Chapter 6.1.15 and see below, section 1).

Proceed as follows:

- First, if you have not already, activate the "Evaluation" view (see Chapter 6), insert a measuring program for computing an alignment point and configure the measuring program in order to obtain an alignment point.
- Now, create a new program group (see Chapter 3.17) and insert the "Point Alignment 2D" program in the "Data preprocessing" section.
- Select the input 2D profile and the alignment point for the program (see below, section "1" and Chapter 3.18.3).

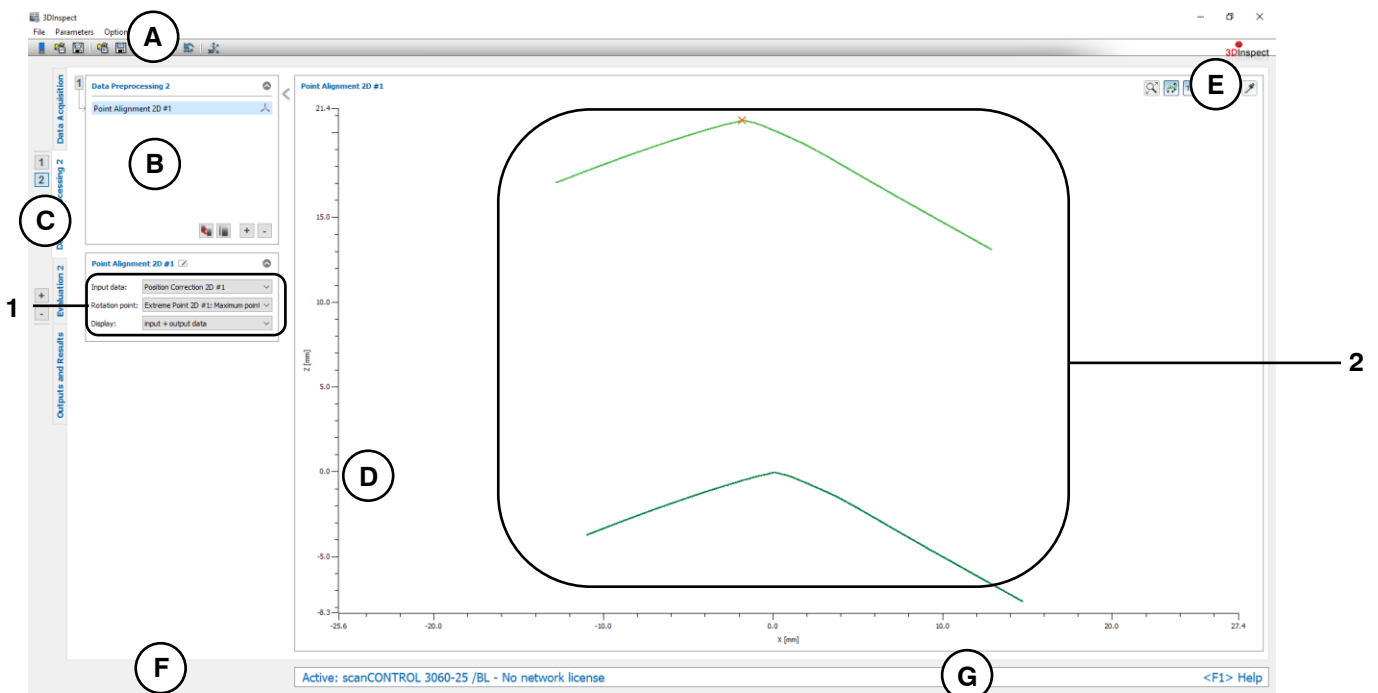

Fig. 5.26: "Point Alignment 2D" Measuring Program

Display Elements and Parameters in the "Point Alignment 2D" Program:

- A** **"General" toolbar:** Using this toolbar, you can select the data source (see Chapter 3.4 and 3.5), save and load parameters (see Chapter 3.20), reset selected parameters to default settings (see Chapter 3.20.3) and undo and restore changes of settings and parameters (see Chapter 3.21).
 - B** **List of active measuring programs:** This section displays the active measuring programs from the "Data preprocessing" group. You can add and remove measuring programs (see Chapter 3.15), move them (see Chapter 3.16) and select an active measuring program for parameterizing and displaying the measured values.
 - C** **Measuring program groups / Tab bar for switching between views:** This tab bar allows you to switch between the four main views (see Chapter 3.2). To the left of the tab bar you find the section for adding, removing and selecting measuring program groups (see Chapter 3.17).
 - D** **2D Profile View:** The 2D Profile View visualizes the 2D data (see Chapter 3.13).
 - E** **"2D Profile View" toolbar:** Use this toolbar to scale the 2D Profile View and activate various options for mouse interaction (see Chapter 3.13).
 - F** **"Start measurement" button:** Click on this button to perform a measuring operation, calculate the measurement results and display the profile and measurement results of the currently selected measuring program in the 2D Profile View.
 - G** **Status bar:** Status and error messages are displayed in the status bar (see Chapter 8.1).
-
- 1** - **Input data:** Use this selection field to select the input data and the alignment point for the program (see also Chapter 3.18.3). An overview of measuring programs which provide 2D points can be found in Chapter 3.19.1.
 - **Display:** Select whether input data, output data or both is displayed in the 2D Profile View.
 - 2** **2D Profile View:** The 2D Profile View shows the input profile (light green), the alignment point (orange) and the aligned profile (green).

5.1.24 "Average Filter 2D" Measuring Program

Use the "Average Filter 2D" program to filter a 2D profile using an average filter.

Note: The "Average Filter 2D" program needs a 2D profile as input data. The "Profile Section" measuring program can be used in order to generate a 2D profile. (see Chapter 5.1.19)

Proceed as follows:

- If applicable, select the input data for the average filter (see below, section "1" and Chapter 3.18.3).
- Select the filter size (see below, section "2").

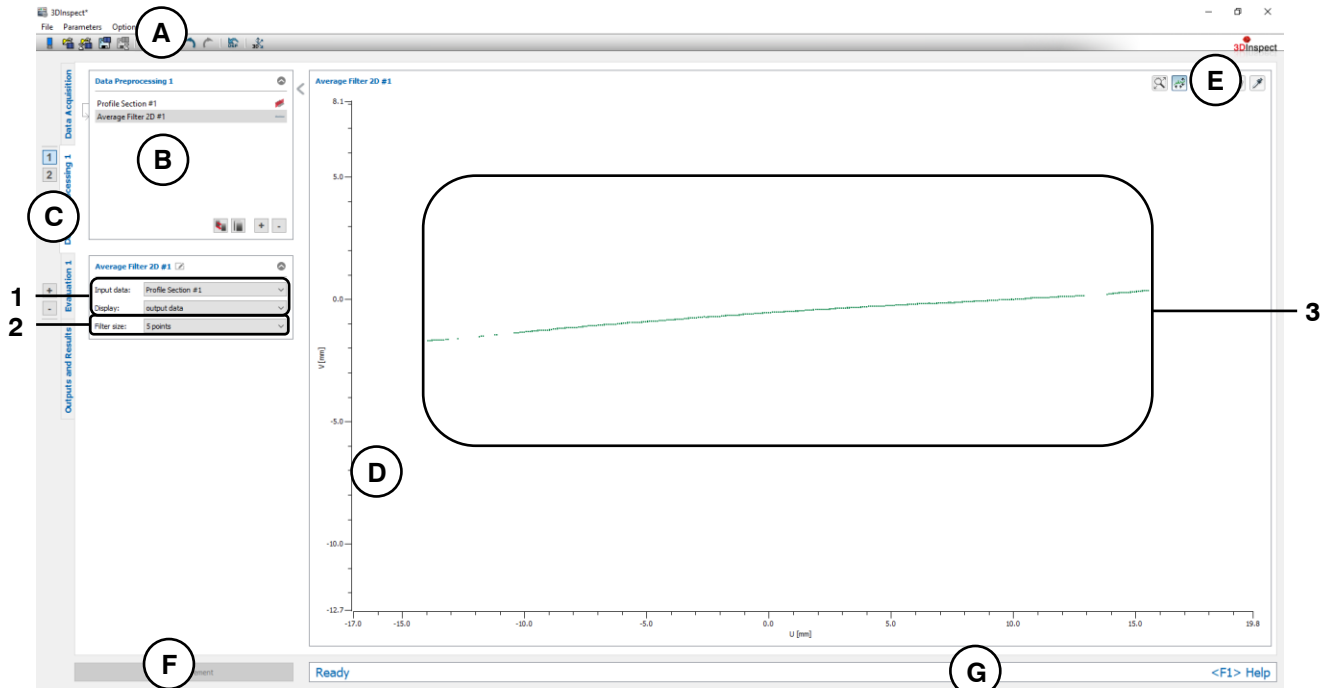

Fig. 5.27: "Average Filter 2D" Measuring Program

Display Elements and Parameters in the "Average Filter 2D" Program:

- A "General" toolbar:** Using this toolbar, you can select the data source (see Chapter 3.4 and 3.5), save and load parameters (see Chapter 3.20), reset selected parameters to default settings (see Chapter 3.20.3) and undo and restore changes of settings and parameters (see Chapter 3.21).
 - B List of active measuring programs:** This section displays the active measuring programs from the "Data preprocessing" group. You can add and remove measuring programs (see Chapter 3.15), move them (see Chapter 3.16) and select an active measuring program for parameterizing and displaying the measured values.
 - C Measuring program groups / Tab bar for switching between views:** This tab bar allows you to switch between the four main views (see Chapter 3.2). To the left of the tab bar you find the section for adding, removing and selecting measuring program groups (see Chapter 3.17).
 - D 2D Profile View:** The 2D Profile View visualizes the 2D data (see Chapter 3.13).
 - E "2D Profile View" toolbar:** Use this toolbar to scale the 2D Profile View and activate various options for mouse interaction (see Chapter 3.13).
 - F "Start measurement" button:** Click on this button to perform a measuring operation, calculate the measurement results and display the profile and measurement results of the currently selected measuring program in the 2D Profile View.
 - G Status bar:** Status and error messages are displayed in the status bar (see Chapter 8.1).
- 1 - **Input data:** Use this selection field to select the input data for the program (see also Chapter 3.18.3).

- **Display:** Select whether input data, output data or both is displayed in the 2D Profile View.
- 2 Filter size:** Select the filter size of the average filter.
- 3 2D Profile View:** The filtered 2D profile is shown in the 2D Profile View.

5.1.25 "Median Filter 2D" Measuring Program

Use the "Median Filter 2D" program to filter a 2D profile using a median filter.

Note: The "Median Filter 2D" program needs a 2D profile as input data. The "Profile Section" measuring program can be used in order to generate a 2D profile. (see Chapter 5.1.19)

Proceed as follows:

- If applicable, select the input data for the median filter (see below, section "1" and Chapter 3.18.3).
- Select the filter size (see below, section "2").

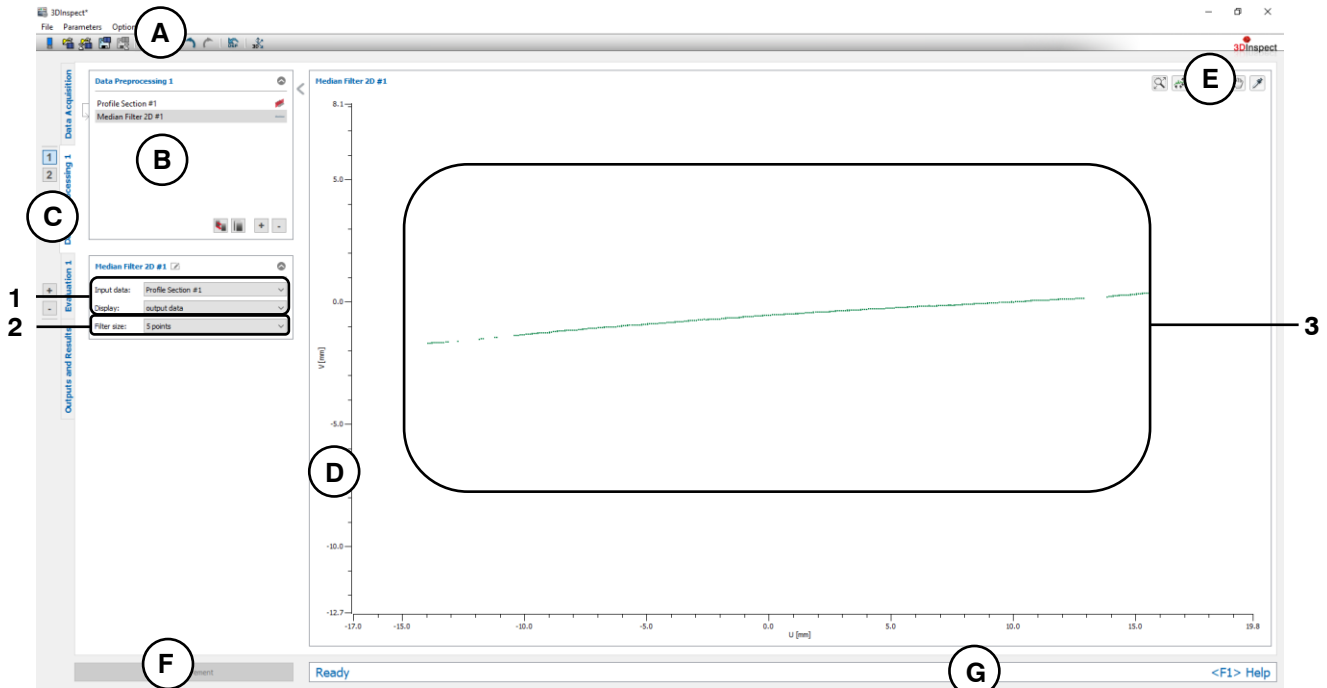

Fig. 5.28: "Median Filter 2D" Measuring Program

Display Elements and Parameters in the "Median Filter 2D" Program:

- A "General" toolbar:** Using this toolbar, you can select the data source (see Chapter 3.4 and 3.5), save and load parameters (see Chapter 3.20), reset selected parameters to default settings (see Chapter 3.20.3) and undo and restore changes of settings and parameters (see Chapter 3.21).
- B List of active measuring programs:** This section displays the active measuring programs from the "Data preprocessing" group. You can add and remove measuring programs (see Chapter 3.15), move them (see Chapter 3.16) and select an active measuring program for parameterizing and displaying the measured values.
- C Measuring program groups / Tab bar for switching between views:** This tab bar allows you to switch between the four main views (see Chapter 3.2). To the left of the tab bar you find the section for adding, removing and selecting measuring program groups (see Chapter 3.17).
- D 2D Profile View:** The 2D Profile View visualizes the 2D data (see Chapter 3.13).
- E "2D Profile View" toolbar:** Use this toolbar to scale the 2D Profile View and activate various options for mouse interaction (see Chapter 3.13).
- F "Start measurement" button:** Click on this button to perform a measuring operation, calculate the measurement results and display the profile and measurement results of the currently selected measuring program in the 2D Profile View.
- G Status bar:** Status and error messages are displayed in the status bar (see Chapter 8.1).
- 1 - Input data:** Use this selection field to select the input data for the program (see also Chapter 3.18.3).

- **Display:** Select whether input data, output data or both is displayed in the 2D Profile View.
- 2 Filter size:** Select the filter size of the median filter.
- 3 2D Profile View:** The filtered profile is shown in the 2D Profile View.

6. Description of the "Evaluation" View

In this view, you can select and parameterize programs for calculating and combining geometric objects.

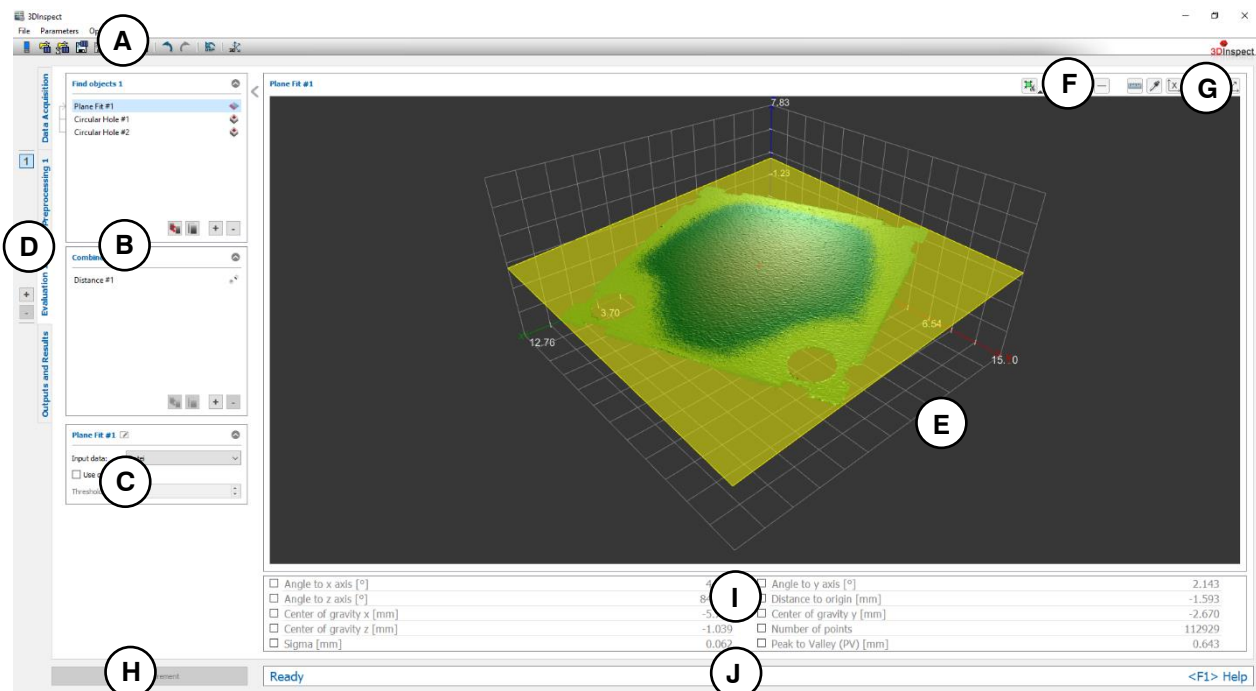

Fig. 6.1: "Evaluation" view

Display Elements and Parameters in the "Evaluation" View:

- A** **"General" toolbar:** Using this toolbar, you can select the data source (see Chapter 3.4 and 3.5), save and load parameters (see Chapter 3.20), reset selected parameters to default settings (see Chapter 3.20.3) and undo and restore changes of settings and parameters (see Chapter 3.21).
- B** **List of active measuring programs:** This section displays the active measuring programs from the "Find objects" and "Combine objects" groups. You can add and remove measuring programs/measuring program groups (see Chapter 3.15 and 3.17), move measuring programs (see Chapter 3.16) and select an active measuring program for parameterizing and displaying the measured values.
- C** **Measuring program parameters:** In this section you can configure the currently selected measuring program (see Chapter 3.18).
- D** **Measuring program groups / Tab bar for switching between views:** This tab bar allows you to switch between the four main views (see Chapter 3.2). To the left of the tab bar you find the section for adding, removing and selecting measuring program groups (see Chapter 3.17).
- E** **2D Profile View/3D-View:** In this area the input data and the regions of interest for the measurement are displayed. Depending on the measuring program, the output data or the calculated results are also displayed. If the measuring program is a 2D measuring program, a 2D profile display is shown (see Chapter 3.13). If the measuring program is a 3D measuring program, on the other hand, a 3D display is shown (see Chapter 3.11).
- F** **"Measuring" toolbar:** Use this toolbar to set various ROIs for the measurement (see Chapter 3.18.4, 3.18.5, 3.18.6 and 3.18.7).
- G** **"2D-View"/3D-View" toolbar:** Use this toolbar to configure the orientation of the coordinate system, display the coordinates of selected points as tooltip and measure distances in the 3D-View interactively (see Chapter 3.11).
- H** **"Start measurement" button:** Click on this button to perform a measuring operation, calculate the measurement results and display the point cloud and measurement results of the currently selected measuring program in the 3D-View.

- I **Results display:** The measurement results of the currently selected measuring program are displayed. Here, you can select which measured values are to be made available later for calculation, OK/nOK assessment, logging and output (see Chapter [3.18.9](#)).
- J **Status bar:** Status and error messages are displayed in the status bar (see Chapter [8.1](#)).

6.1 Description of the Measuring Programs in the "Find Objects" Group

In this group, you will find programs for fitting geometric objects.

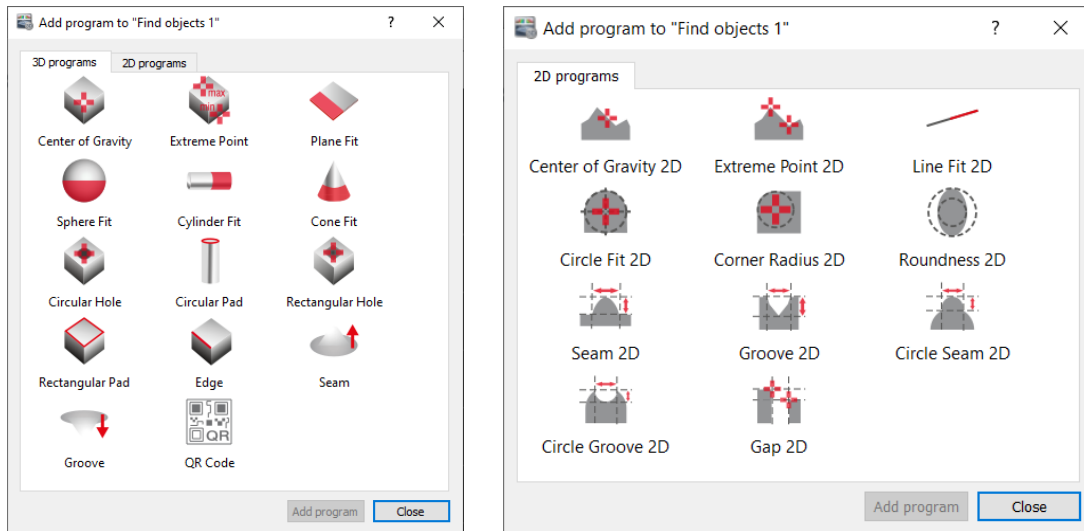

Fig. 6.2: "Find objects" group

Measuring Programs in the "Find Objects" Group:

- Center of Gravity: Calculate the center of gravity of 3D points (see Chapter 6.1.1).
- Extreme Point: Calculate an extreme point of 3D points (see Chapter 6.1.2).
- Plane Fit: Calculate a fitting plane through 3D points (see Chapter 6.1.3).
- Sphere Fit: Calculate a fitting sphere through 3D points (see Chapter 6.1.4).
- Cylinder Fit: Calculate a fitting cylinder through 3D points (see Chapter 6.1.5).
- Cone Fit: Calculate a fitting cone through 3D points (see Chapter 6.1.6).
- Circular Hole: Measure a circular hole in a point cloud (see Chapter 6.1.7).
- Circular Pad: Measure a circular pad in a point cloud (see Chapter 6.1.8).
- Rectangular Hole: Measure a rectangular hole in a point cloud (see Chapter 6.1.9).
- Rectangular Pad: Measure a rectangular pad in a point cloud (see Chapter 6.1.10).
- Edge: Measure a straight edge in a point cloud (see Chapter 6.1.11).
- Seam: Measure a seam in a point cloud (see Chapter 6.1.12).
- Groove: Measure a groove in a point cloud (see Chapter 6.1.13).
- QR Code: Reads a QR Code from a point cloud (see Chapter 6.1.14).
- Center of Gravity 2D: Calculate the center of gravity of 2D points (see Chapter 6.1.15).
- Extreme Point 2D: Calculate an extreme point of 2D points (see Chapter 6.1.16).
- Line Fit 2D: Calculate a fitting line through 2D points (see Chapter 6.1.17).
- Circle Fit 2D: Calculate a fitting circle through 2D points (see Chapter 6.1.18).
- Corner Radius 2D: Calculate the radius of a 2D corner (see Chapter 6.1.19).
- Roundness 2D: Calculate the roundness of a 2D object (see Chapter 6.1.20).
- Seam 2D: Measure a seam in a 2D profile (see Chapter 6.1.21).
- Groove 2D: Measure a groove in a 2D profile (see Chapter 6.1.22).
- Circle Seam 2D: Measure a seam in a circular 2D profile (see Chapter 6.1.23).
- Circle Groove 2D: Measure a groove in a circular 2D profile (see Chapter 6.1.24).
- Gap 2D: Measure a gap in a 2D profile (see Chapter 6.1.25).

6.1.1 "Center of Gravity" Measuring Program

Use the "Center of Gravity" program to calculate the center of gravity of 3D points. Proceed as follows:

- If applicable, select the input data for the program (see below, section "1" and Chapter 3.18.3).
- If necessary, limit the range for the center of gravity calculation in order to eliminate interfering points (see section "E" and Chapter 3.18.4, 3.18.6 and 3.18.7).
- If applicable, select measured values that are to be used later for calculation, OK/nOK assessment, logging and output (see below, section "H" and Chapter 3.18.9).

The measuring program outputs the following measured values:

- **Center of gravity x:** The X coordinate of the calculated center of gravity of the current point cloud.
- **Center of gravity y:** The Y coordinate of the calculated center of gravity of the current point cloud.
- **Center of gravity z:** The Z coordinate of the calculated center of gravity of the current point cloud.
- **Number of points:** The number of selected points in the current point cloud that were used to calculate the center of gravity.
- **Sigma:** The standard deviation of the distances of the points to the center of gravity.

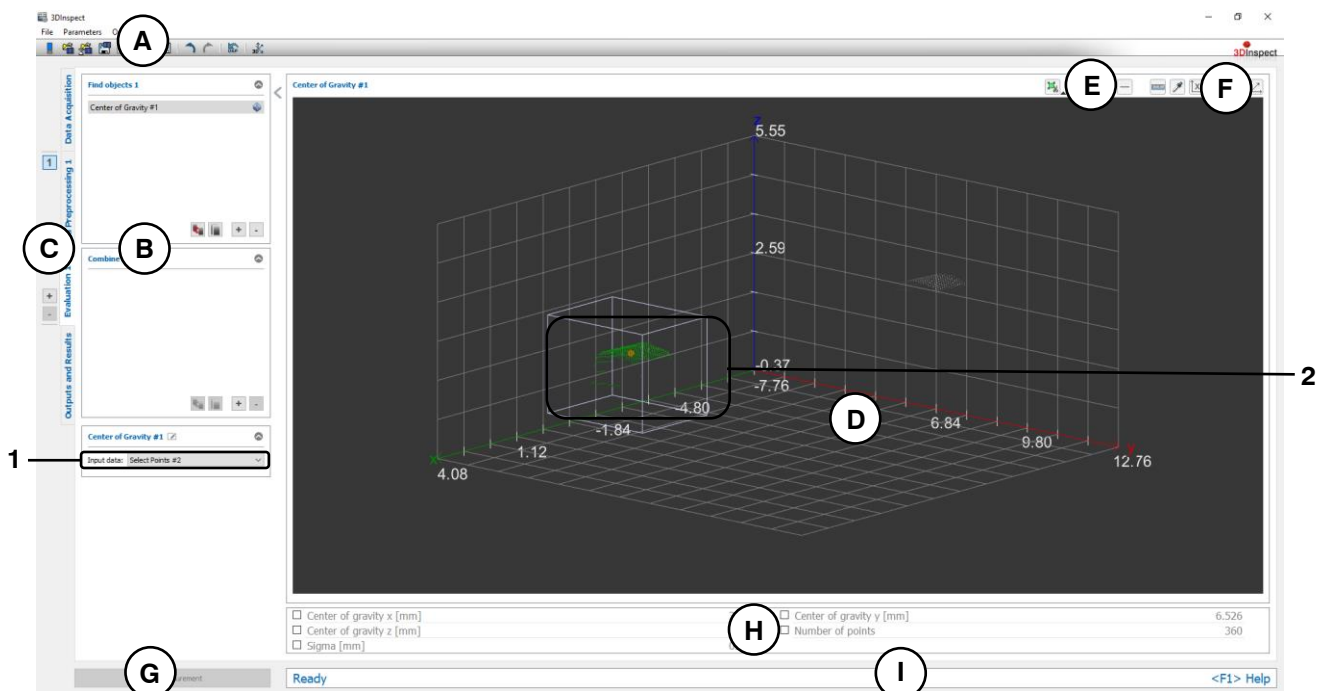

Fig. 6.3: "Center of Gravity" Measuring Program

Display Elements and Parameters in the "Center of Gravity" Program:

- A "General" toolbar:** Using this toolbar, you can select the data source (see Chapter 3.4 and 3.5), save and load parameters (see Chapter 3.20), reset selected parameters to default settings (see Chapter 3.20.3) and undo and restore changes of settings and parameters (see Chapter 3.21).
- B List of active measuring programs:** This section displays the active measuring programs from the "Find objects" and "Combine objects" groups. You can add and remove measuring programs/measuring program groups (see Chapter 3.15 and 3.17), move measuring programs (see Chapter 3.16) and select an active measuring program for parameterizing and displaying the measured values.
- C Measuring program groups / Tab bar for switching between views:** This tab bar allows you to switch between the four main views (see Chapter 3.2). To the left of the tab bar you find the section for adding, removing and selecting measuring program groups (see Chapter 3.17).
- D 3D-View:** The 3D-View visualizes the 3D data (see Chapter 3.11).
- E "Measuring" toolbar:** Use this toolbar to set various ROIs for the measurement (see Chapter 3.18.4, 3.18.6 and 3.18.7).

- F** **"3D-View" toolbar:** Use this toolbar to configure the orientation of the coordinate system and activate various options for mouse interaction in the 3D-View (see Chapter [3.11](#)).
 - G** **"Start measurement" button:** Click on this button to perform a measuring operation, calculate the measurement results and display the point cloud and measurement results of the currently selected measuring program in the 3D-View.
 - H** **Results display:** The measurement results of the currently selected measuring program are displayed. Here, you can select which measured values are to be made available later for calculation, OK/nOK assessment, logging and output (see Chapter [3.18.9](#)).
 - I** **Status bar:** Status and error messages are displayed in the status bar (see Chapter [8.1](#)).
-
- 1** **Input data:** Use this selection field to select the input data for the program (see also Chapter [3.18.3](#)).
 - 2** **3D-View:** The calculated center of gravity is displayed as an orange point in the 3D-View. The points that were used to calculate the center of gravity (green) and the discarded points (gray) are displayed.

6.1.2 "Extreme Point" Measuring Program

Use the "Extreme Point" program to determine extreme points of 3D points. Proceed as follows:

- If applicable, select the input data for the program (see below, section "1" and Chapter 3.18.3).
- If necessary, limit the range for determining the extreme points in order to eliminate interfering points (see section "E" and Chapter 3.18.4, 3.18.6 and 3.18.7).
- Select the direction of the extreme points to be determined (see below, section "2").
- If applicable, select measured values that are to be used later for calculation, OK/nOK assessment, logging and output (see below, section "H" and Chapter 3.18.9).

The measuring program outputs the following measured values:

- **Minimum point x:** The X coordinate of the minimum point in the selected direction.
- **Minimum point y:** The Y coordinate of the minimum point in the selected direction.
- **Minimum point z:** The Z coordinate of the minimum point in the selected direction.
- **Maximum point x:** The X coordinate of the maximum point in the selected direction.
- **Maximum point y:** The Y coordinate of the maximum point in the selected direction.
- **Maximum point z:** The Z coordinate of the maximum point in the selected direction.
- **Number of points:** The number of selected points in the current point cloud that were used to determine the extreme points.

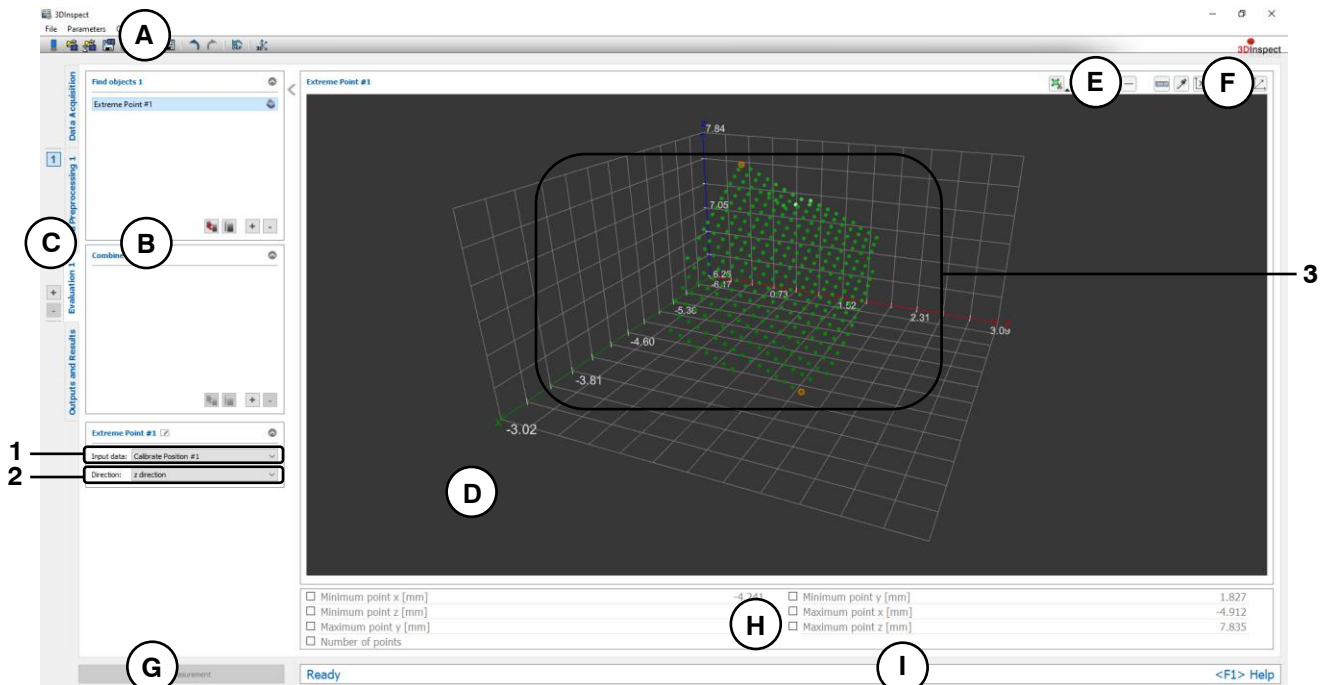

Fig. 6.4: "Extreme Point" Measuring Program

Display Elements and Parameters in the "Extreme Point" Program:

- A "General" toolbar:** Using this toolbar, you can select the data source (see Chapter 3.4 and 3.5), save and load parameters and reset selected parameters to default settings (see Chapter 3.20.3).
- B List of active measuring programs:** This section displays the active measuring programs from the "Find objects" and "Combine objects" groups. You can add and remove measuring programs/measuring program groups (see Chapter 3.15 and 3.17), move measuring programs (see Chapter 3.16) and select an active measuring program for parameterizing and displaying the measured values.
- C Measuring program groups / Tab bar for switching between views:** This tab bar allows you to switch between the four main views (see Chapter 3.2). To the left of the tab bar you find the section for adding, removing and selecting measuring program groups (see Chapter 3.17).
- D 3D-View:** The 3D-View visualizes the 3D data (see Chapter 3.11).

- E** **"Measuring" toolbar:** Use this toolbar to set various ROIs for the measurement (see Chapter 3.18.4, 3.18.6 and 3.18.7).
 - F** **"3D-View" toolbar:** Use this toolbar to configure the orientation of the coordinate system and activate various options for mouse interaction in the 3D-View (see Chapter 3.11).
 - G** **"Start measurement" button:** Click on this button to perform a measuring operation, calculate the measurement results and display the point cloud and measurement results of the currently selected measuring program in the 3D-View.
 - H** **Results display:** The measurement results of the currently selected measuring program are displayed. Here, you can select which measured values are to be made available later for calculation, OK/nOK assessment, logging and output (see Chapter 3.18.9).
 - I** **Status bar:** Status and error messages are displayed in the status bar (see Chapter 8.1).
-
- 1** **Input data:** Use this selection field to select the input data for the program (see also Chapter 3.18.3).
 - 2** **Algorithm:** Select the direction in space for determining the extreme points. The following options are available:
 - **x direction:** Determine the extreme points in the X direction.
 - **y direction:** Determine the extreme points in the Y direction.
 - **z direction:** Determine the extreme points in the Z direction.
 - 3** **3D-View:** The determined extreme points are displayed as orange points in the 3D-View. The points that were used to determine the extreme point (green) and the discarded points (gray) are displayed.

6.1.3 "Plane Fit" Measuring Program

Use the "Plane Fit" program to calculate a plane at 3D points. Proceed as follows:

- If applicable, select the input data for the program (see below, section "1" and Chapter 3.18.3).
- If necessary, limit the range for the plane calculation in order to eliminate interfering points (see section "E" and Chapter 3.18.4, 3.18.6 and 3.18.7).
- If required, activate the optimized fit and enter a suitable threshold for the optimized fit (see below, section "2").
- If applicable, select measured values that are to be used later for calculation, OK/nOK assessment, logging and output (see below, section "H" and Chapter 3.18.9).

The measuring program outputs the following measured values:

- **Angle to x axis:** The angle of the calculated plane with respect to the X axis.
- **Angle to y axis:** The angle of the calculated plane with respect to the Y axis.
- **Angle to z axis:** The angle of the calculated plane with respect to the Z axis.
- **Distance to origin:** The distance between the plane and the origin of the coordinate system.
- **Center of gravity x:** The X coordinate of the center of gravity of the points that were used to calculate the plane.
- **Center of gravity y:** The Y coordinate of the center of gravity of the points that were used to calculate the plane.
- **Center of gravity z:** The Z coordinate of the center of gravity of the points that were used to calculate the plane.
- **Number of points:** The number of points in the point cloud that were used to calculate the plane.
- **Sigma:** The standard deviation of the distances between the points that were used to calculate the plane and the calculated plane.
- **Peak to Valley (PV):** The distance between the highest and lowest point relative to the calculated plane. The highest and lowest point is determined from the points that were used to calculate the plane.

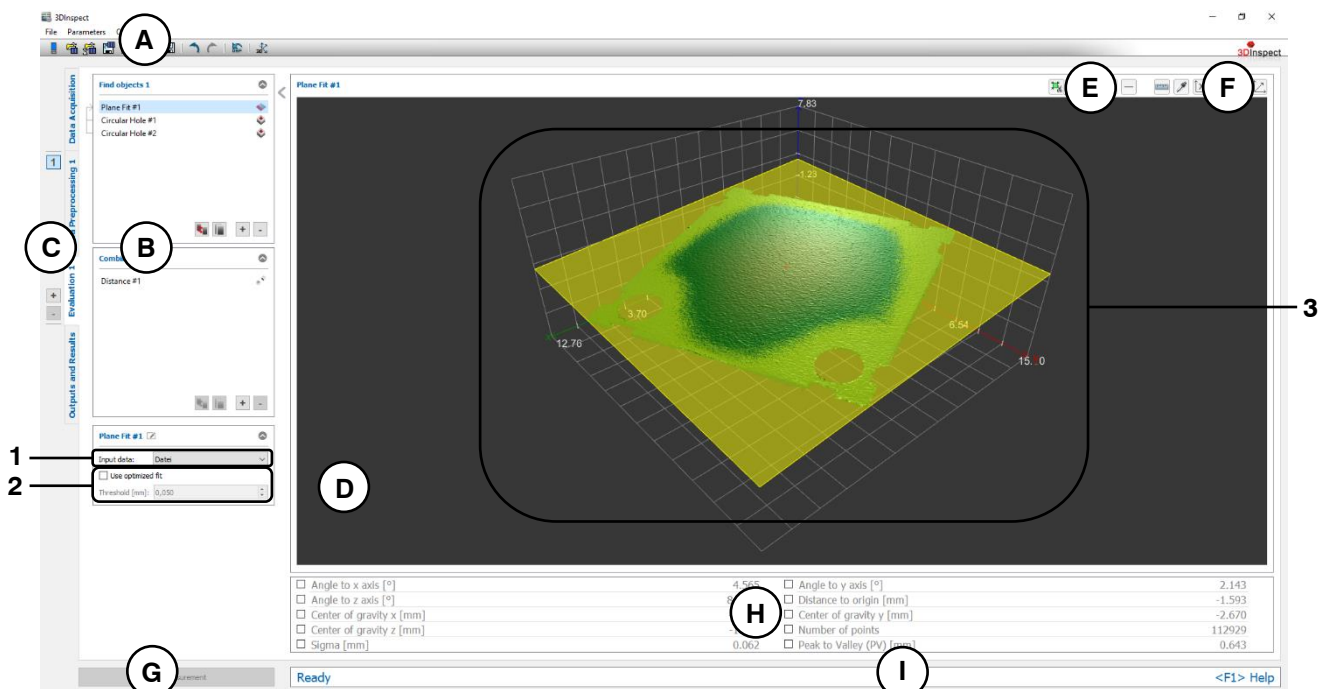

Fig. 6.5: "Plane Fit" Measuring Program

Display Elements and Parameters in the "Plane Fit" Program:

- A "General" toolbar:** Using this toolbar, you can select the data source (see Chapter 3.4 and 3.5), save and load parameters (see Chapter 3.20), reset selected parameters to default settings (see Chapter 3.20.3) and undo and restore changes of settings and parameters (see Chapter 3.21).

- B List of active measuring programs:** This section displays the active measuring programs from the "Find objects" and "Combine objects" groups. You can add and remove measuring programs/measuring program groups (see Chapter 3.15 and 3.17), move measuring programs (see Chapter 3.16) and select an active measuring program for parameterizing and displaying the measured values.
 - C Measuring program groups / Tab bar for switching between views:** This tab bar allows you to switch between the four main views (see Chapter 3.2). To the left of the tab bar you find the section for adding, removing and selecting measuring program groups (see Chapter 3.17).
 - D 3D-View:** The 3D-View visualizes the 3D data (see Chapter 3.11).
 - E "Measuring" toolbar:** Use this toolbar to set various ROIs for the measurement (see Chapter 3.18.4, 3.18.6 and 3.18.7).
 - F "3D-View" toolbar:** Use this toolbar to configure the orientation of the coordinate system and activate various options for mouse interaction in the 3D-View (see Chapter 3.11).
 - G "Start measurement" button:** Click on this button to perform a measuring operation, calculate the measurement results and display the point cloud and measurement results of the currently selected measuring program in the 3D-View.
 - H Results display:** The measurement results of the currently selected measuring program are displayed. Here, you can select which measured values are to be made available later for calculation, OK/nOK assessment, logging and output (see Chapter 3.18.9).
 - I Status bar:** Status and error messages are displayed in the status bar (see Chapter 8.1).
- 1 Input data:** Use this selection field to select the input data for the program (see also Chapter 3.18.3).
 - 2**
 - **Use optimized fit:** When this parameter is activated, an additional preselection of points is applied prior to the plane fit in order to automatically discard outliers or points that do not belong to the plane. The points are selected such that the distances from the resulting plane are less than the predefined threshold and such that the maximum possible number of points is used. Therefore, only the points that best match the plane are used for the plane fit. The optimized fit is suitable for
 - discarding outlier points/point accumulations during plane fitting
 - considering only the main geometry in the case of small "secondary geometries" presentThe optimized fit is not suitable to achieve improvements within the basic noise of the data.
 - **Threshold [mm]:** The threshold for the preselection of the points. Points that deviate from the plane to a smaller degree than the threshold are used for the plane fit. A higher threshold means that more points are used for the plane fit.
 - 3 3D-View:** The 3D-View shows the fitted plane (yellow) and the center of gravity (orange) of the points that were used for the plane fit. The points that were used to calculate the plane are shown with a color gradient ("Colors" palette, see Chapter 8.4). The points that best match the plane are shown in green. The discarded points are shown in gray.

6.1.4 "Sphere Fit" Measuring Program

Use the "Sphere Fit" program to calculate a sphere at 3D points. Proceed as follows:

- If applicable, select the input data for the program (see below, section "1" and Chapter 3.18.3).
- If necessary, limit the range for the sphere calculation in order to eliminate interfering points (see below, section "E" and Chapter 3.18.4, 3.18.6 and 3.18.7).
- If required, activate the optimized fit and enter a suitable threshold for the optimized fit (see below, section "2").
- If applicable, select measured values that are to be used later for calculation, OK/nOK assessment, logging and output (see below, section "H" and Chapter 3.18.9).

The measuring program outputs the following measured values:

- **Center x:** The X coordinate of the center point of the calculated sphere.
- **Center y:** The Y coordinate of the center point of the calculated sphere.
- **Center z:** The Z coordinate of the center point of the calculated sphere.
- **Radius:** The radius of the calculated sphere.
- **Number of points:** The number of points in the point cloud that were used to calculate the sphere.
- **Sigma:** The standard deviation of the distances between the points that were used to calculate the sphere and the surface of the calculated sphere.
- **Peak to Valley (PV):** The distance between the two points that are furthest away inwards and outwards from the sphere, relative to the computed sphere. The two points are determined from the points that were used to calculate the sphere.

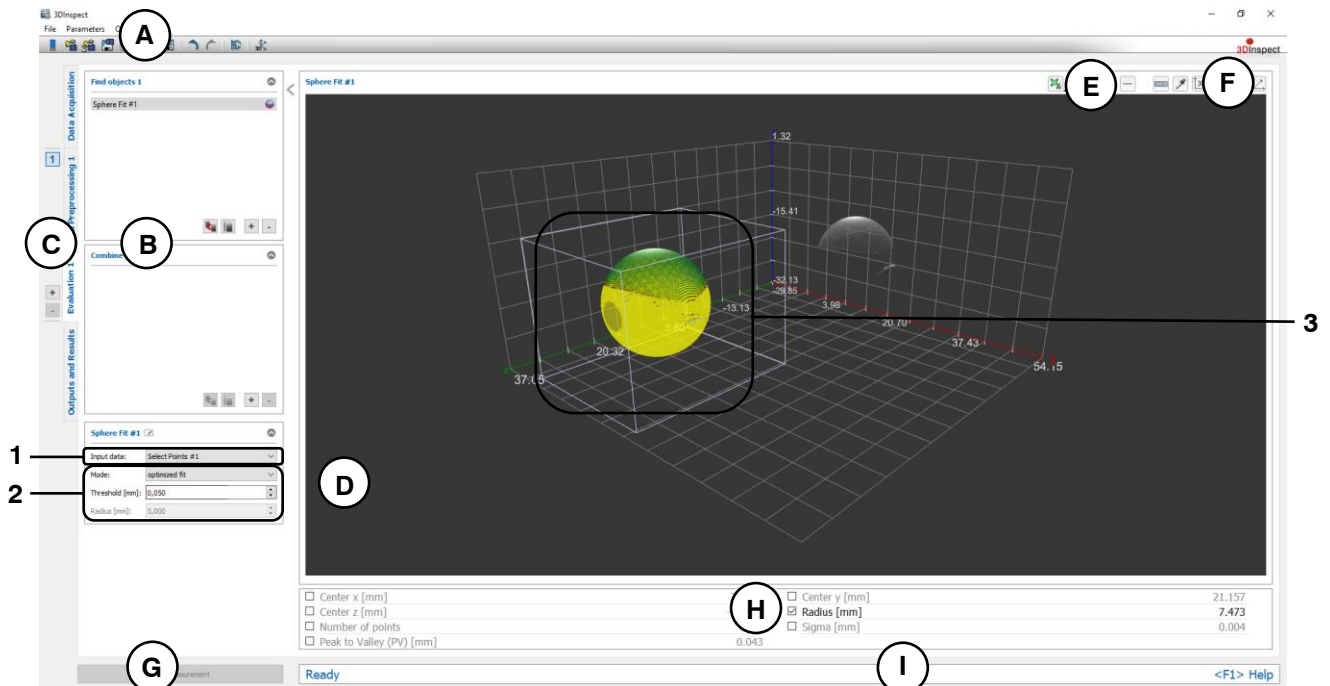

Fig. 6.6: "Sphere Fit" Measuring Program

Display Elements and Parameters in the "Sphere Fit" Program:

- A "General" toolbar:** Using this toolbar, you can select the data source (see Chapter 3.4 and 3.5), save and load parameters (see Chapter 3.20), reset selected parameters to default settings (see Chapter 3.20.3) and undo and restore changes of settings and parameters (see Chapter 3.21).
- B List of active measuring programs:** This section displays the active measuring programs from the "Find objects" and "Combine objects" groups. You can add and remove measuring programs/measuring program groups (see Chapter 3.15 and 3.17), move measuring programs (see Chapter 3.16) and select an active measuring program for parameterizing and displaying the measured values.

- C Measuring program groups / Tab bar for switching between views:** This tab bar allows you to switch between the four main views (see Chapter 3.2). To the left of the tab bar you find the section for adding, removing and selecting measuring program groups (see Chapter 3.17).
- D 3D-View:** The 3D-View visualizes the 3D data (see Chapter 3.11).
- E "Measuring" toolbar:** Use this toolbar to set various ROIs for the measurement (see Chapter 3.18.4, 3.18.6 and 3.18.7).
- F "3D-View" toolbar:** Use this toolbar to configure the orientation of the coordinate system and activate various options for mouse interaction in the 3D-View (see Chapter 3.11).
- G "Start measurement" button:** Click on this button to perform a measuring operation, calculate the measurement results and display the point cloud and measurement results of the currently selected measuring program in the 3D-View.
- H Results display:** The measurement results of the currently selected measuring program are displayed. Here, you can select which measured values are to be made available later for calculation, OK/nOK assessment, logging and output (see Chapter 3.18.9).
- I Status bar:** Status and error messages are displayed in the status bar (see Chapter 8.1).
- 1 Input data:** Use this selection field to select the input data for the program (see also Chapter 3.18.3).
- 2 - Mode:** The following modes are available for sphere fit:
- **Standard:** All points which are inside the selection ranges are used for computing the sphere fit.
 - **Optimized fit:** When this option is activated, an additional preselection of the points is applied prior to the sphere fit in order to automatically discard outliers or points that do not belong to the sphere. The points are selected such that the distances from the resulting sphere are less than the predefined threshold and such that the maximum possible number of points is used. Therefore, only the points that best match the sphere are used for the sphere fit.
The optimized fit is suitable for
 - discarding outlier points/point accumulations during sphere fitting
 - considering only the main geometry in the case of small "secondary geometries" present
 The optimized fit is not suitable to achieve improvements within the basic noise of the data.
 - **Fixed radius:** If the radius of the sphere is well known, you may force the radius with this option. Thus the computation of the position of the sphere is more precise.
- **Threshold [mm]:** The threshold for the preselection of the points in case of an activated "Optimized fit" option. Points that deviate from the sphere to a smaller degree than the threshold are used for the sphere fit. A higher threshold means that more points are used for the sphere fit.
- **Radius:** Here you may specify the radius of the sphere in case of an activated "Fixed radius" option.
- 3 3D-View:** The 3D-View shows the fitted sphere (yellow). The points that were used to calculate the sphere are shown with a color gradient ("Colors" palette, see Chapter 8.4). The points that best match the sphere are shown in green. The discarded points are shown in gray.

6.1.5 "Cylinder Fit" Measuring Program

Use the "Cylinder Fit" program to calculate a cylinder at 3D points. Proceed as follows:

- If applicable, select the input data for the program (see below, section "1" and Chapter 3.18.3).
- If necessary, limit the range for the cylinder calculation in order to eliminate interfering points (see section "E" and Chapter 3.18.4, 3.18.6 and 3.18.7).
- If required, activate the optimized fit and enter a suitable threshold for the optimized fit (see below, section "2").
- If applicable, select measured values that are to be used later for calculation, OK/nOK assessment, logging and output (see below, section "H" and Chapter 3.18.9).

The measuring program outputs the following measured values:

- **Angle to x/y plane:** The angle of the longitudinal axis of the calculated cylinder with respect to the X/Y plane.
- **Angle to y/z plane:** The angle of the longitudinal axis of the calculated cylinder with respect to the Y/Z plane.
- **Angle to z/x plane:** The angle of the longitudinal axis of the calculated cylinder with respect to the Z/X plane.
- **Axis direction x:** The X component of the direction vector of the cylinder axis.
- **Axis direction y:** The Y component of the direction vector of the cylinder axis.
- **Axis direction z:** The Z component of the direction vector of the cylinder axis.
- **Radius:** The radius of the calculated cylinder.
- **Number of points:** The number of points in the point cloud that were used to calculate the cylinder.
- **Sigma:** The standard deviation of the distances between the points that were used to calculate the cylinder and the surface of the calculated cylinder.
- **Peak to Valley (PV):** The distance between the two points that are furthest away inwards and outwards from the surface of the cylinder, relative to the computed cylinder. The two points are determined from the points that were used to calculate the cylinder.

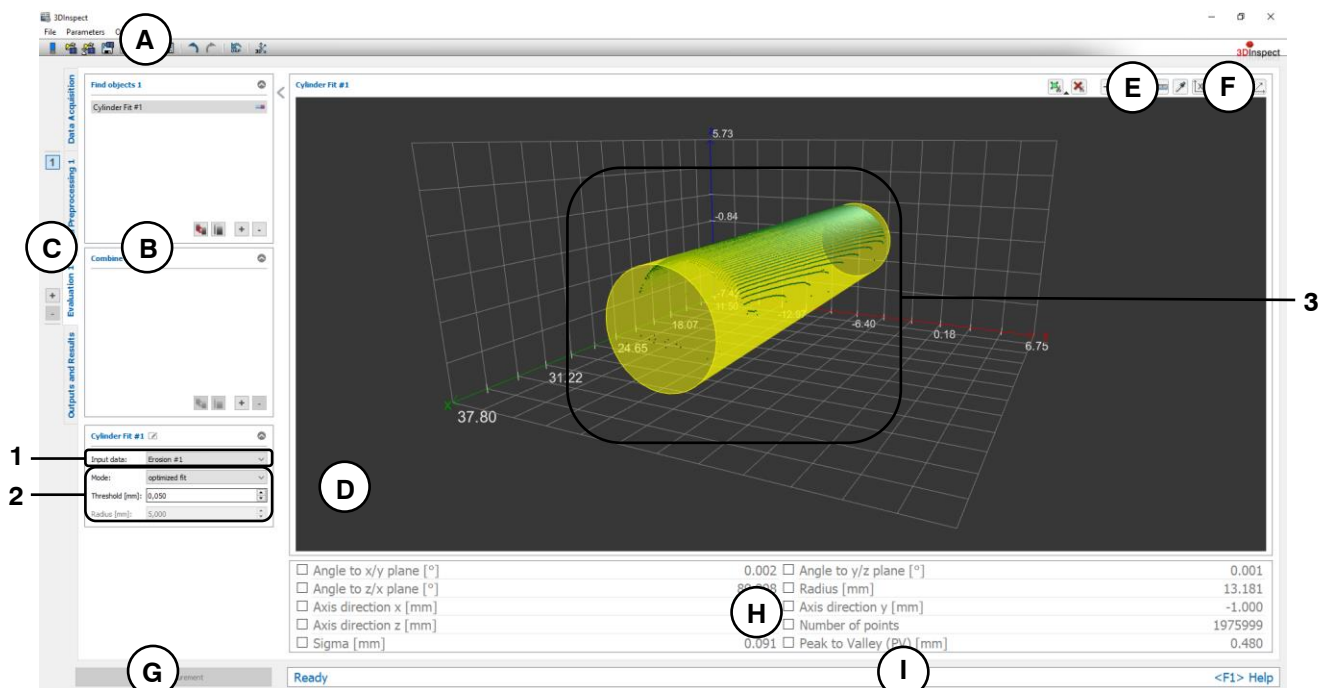

Fig. 6.7: "Cylinder Fit" Measuring Program

Display Elements and Parameters in the "Cylinder Fit" Program:

- A "General" toolbar:** Using this toolbar, you can select the data source (see Chapter 3.4 and 3.5), save and load parameters (see Chapter 3.20), reset selected parameters to default settings (see Chapter 3.20.3) and undo and restore changes of settings and parameters (see Chapter 3.21).

- B List of active measuring programs:** This section displays the active measuring programs from the "Find objects" and "Combine objects" groups. You can add and remove measuring programs/measuring program groups (see Chapter 3.15 and 3.17), move measuring programs (see Chapter 3.16) and select an active measuring program for parameterizing and displaying the measured values.
- C Measuring program groups / Tab bar for switching between views:** This tab bar allows you to switch between the four main views (see Chapter 3.2). To the left of the tab bar you find the section for adding, removing and selecting measuring program groups (see Chapter 3.17).
- D 3D-View:** The 3D-View visualizes the 3D data (see Chapter 3.11).
- E "Measuring" toolbar:** Use this toolbar to set various ROIs for the measurement (see Chapter 3.18.4, 3.18.6 and 3.18.7).
- F "3D-View" toolbar:** Use this toolbar to configure the orientation of the coordinate system and activate various options for mouse interaction in the 3D-View (see Chapter 3.11).
- G "Start measurement" button:** Click on this button to perform a measuring operation, calculate the measurement results and display the point cloud and measurement results of the currently selected measuring program in the 3D-View.
- H Results display:** The measurement results of the currently selected measuring program are displayed. Here, you can select which measured values are to be made available later for calculation, OK/nOK assessment, logging and output (see Chapter 3.18.9).
- I Status bar:** Status and error messages are displayed in the status bar (see Chapter 8.1).
- 1 Input data:** Use this selection field to select the input data for the program (see also Chapter 3.18.3).
- 2**
- **Mode:** The following modes are available for cylinder fit:
 - **Standard:** All points which are inside the ROIs are used for computing the cylinder fit.
 - **Optimized fit:** When this option is activated, an additional preselection of the points is applied prior to the cylinder fit in order to automatically discard outliers or points that do not belong to the cylinder. The points are selected such that the distances from the resulting cylinder are less than the predefined threshold and such that the maximum possible number of points is used. Therefore, only the points that best match the cylinder are used for the cylinder fit.

The optimized fit is suitable for

 - discarding outlier points/point accumulations during cylinder fitting
 - considering only the main geometry in the case of small "secondary geometries" present

The optimized fit is not suitable to achieve improvements within the basic noise of the data.
 - **Fixed radius:** If the radius of the cylinder is well known, you may force the radius with this option. Thus the computation of the position of the cylinder is more precise.
 - **Threshold [mm]:** The threshold for the preselection of the points in case of an activated "Optimized fit" option. Points that deviate from the cylinder to a smaller degree than the threshold are used for the cylinder fit. A higher threshold means that more points are used for the cylinder fit.
 - **Radius:** Here you may specify the radius of the cylinder in case of an activated "Fixed radius" option.
- 3 3D-View:** The 3D-View shows the fitted cylinder (yellow). The points that were used to calculate the cylinder are shown with a color gradient ("Colors" palette, see Chapter 8.4). The points that best match the cylinder are shown in green. The discarded points are shown in gray.

6.1.6 "Cone Fit" Measuring Program

Use the "Cone Fit" program to calculate a cone at 3D points. Proceed as follows:

- If applicable, select the input data for the program (see below, section "1" and Chapter 3.18.3).
- If necessary, limit the range for the cone calculation in order to eliminate interfering points (see section "E" and Chapter 3.18.4, 3.18.6 and 3.18.7).
- If required, activate the optimized fit and enter a suitable threshold for the optimized fit (see below, section "2").
- If applicable, select measured values that are to be used later for calculation, OK/nOK assessment, logging and output (see below, section "H" and Chapter 3.18.9).

The measuring program outputs the following measured values:

- **Angle to x/y plane:** The angle of the longitudinal axis of the calculated cone with respect to the X/Y plane.
- **Angle to y/z plane:** The angle of the longitudinal axis of the calculated cone with respect to the Y/Z plane.
- **Angle to z/x plane:** The angle of the longitudinal axis of the calculated cone with respect to the Z/X plane.
- **Axis direction x:** The X component of the direction vector of the cone axis.
- **Axis direction y:** The Y component of the direction vector of the cone axis.
- **Axis direction z:** The Z component of the direction vector of the cone axis.
- **Opening Angle:** Half the opening angle of the calculated cone.
- **Number of points:** The number of points in the point cloud that were used to calculate the cone.
- **Sigma:** The standard deviation of the distances between the points that were used to calculate the cone and the surface of the calculated cone.
- **Peak to Valley (PV):** The distance between the two points that are furthest away inwards and outwards from the surface of the cone, relative to the computed cone. The two points are determined from the points that were used to calculate the cone.

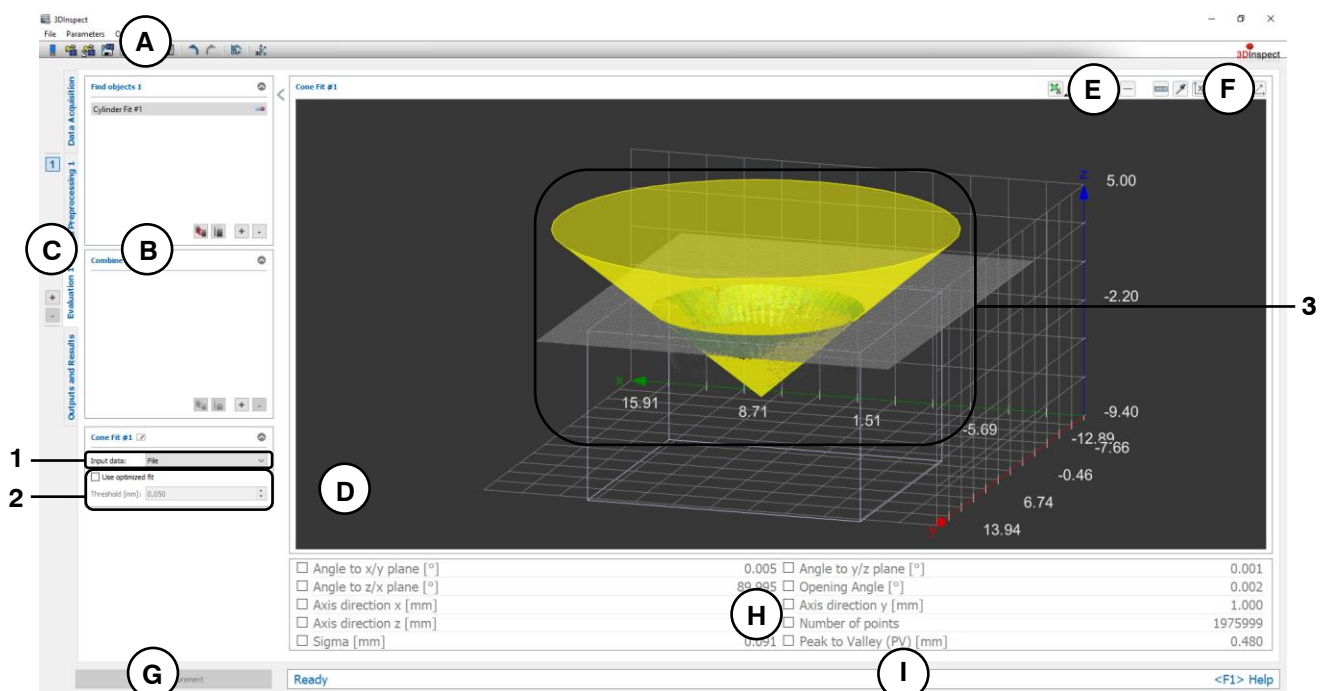

Fig. 6.8: "Cone Fit" Measuring Program

Display Elements and Parameters in the "Cone Fit" Program:

- A "General" toolbar:** Using this toolbar, you can select the data source (see Chapter 3.4 and 3.5), save and load parameters (see Chapter 3.20), reset selected parameters to default settings (see Chapter 3.20.3) and undo and restore changes of settings and parameters (see Chapter 3.21).

- B List of active measuring programs:** This section displays the active measuring programs from the "Find objects" and "Combine objects" groups. You can add and remove measuring programs/measuring program groups (see Chapter 3.15 and 3.17), move measuring programs (see Chapter 3.16) and select an active measuring program for parameterizing and displaying the measured values.
- C Measuring program groups / Tab bar for switching between views:** This tab bar allows you to switch between the four main views (see Chapter 3.2). To the left of the tab bar you find the section for adding, removing and selecting measuring program groups (see Chapter 3.17).
- D 3D-View:** The 3D-View visualizes the 3D data (see Chapter 3.11).
- E "Measuring" toolbar:** Use this toolbar to set various ROIs for the measurement (see Chapter 3.18.4, 3.18.6 and 3.18.7).
- F "3D-View" toolbar:** Use this toolbar to configure the orientation of the coordinate system and activate various options for mouse interaction in the 3D-View (see Chapter 3.11).
- G "Start measurement" button:** Click on this button to perform a measuring operation, calculate the measurement results and display the point cloud and measurement results of the currently selected measuring program in the 3D-View.
- H Results display:** The measurement results of the currently selected measuring program are displayed. Here, you can select which measured values are to be made available later for calculation, OK/nOK assessment, logging and output (see Chapter 3.18.9).
- I Status bar:** Status and error messages are displayed in the status bar (see Chapter 8.1).
- 1 Input data:** Use this selection field to select the input data for the program (see also Chapter 3.18.3).
- 2 Use optimized fit:** When this option is activated, an additional preselection of the points is applied prior to the cone fit in order to automatically discard outliers or points that do not belong to the cone. The points are selected such that the distances from the resulting cone are less than the predefined threshold and such that the maximum possible number of points is used. Therefore, only the points that best match the cone are used for the cone fit. The optimized fit is suitable for
- discarding outlier points/point accumulations during cone fitting
 - considering only the main geometry in the case of small "secondary geometries" present
- The optimized fit is not suitable to achieve improvements within the basic noise of the data.
- **Threshold [mm]:** The threshold for the preselection of the points in case of an activated "Optimized fit" option. Points that deviate from the cone to a smaller degree than the threshold are used for the cone fit. A higher threshold means that more points are used for the cone fit.
- 3 3D-View:** The 3D-View shows the fitted cone (yellow). The points that were used to calculate the cone are shown with a color gradient ("Colors" palette, see Chapter 8.4). The points that best match the cone are shown in green. The discarded points are shown in gray.

6.1.7 "Circular Hole" Measuring Program

Use the "Circular Hole" program to measure a circular hole in a point cloud.

Note: The "Circular Hole" program also requires a reference plane in addition to the point cloud as input data. This reference plane can be calculated using the "Plane Fit" (see Chapter 6.1.3) or "Plane Creation" (see Chapter 6.2.7) measuring program.

Proceed as follows:

- First, if you have not already, insert the "Plane Fit" or the "Plane Creation" measuring program and configure the measuring program in order to obtain a reference plane. Move the measuring program such that it comes before the "Circular Hole" program in the list of active measuring programs (see Chapter 3.16).
- Select the input point cloud and the reference plane for the program (see below, section "1" and Chapter 3.18.3).
- Define a ROI for the hole measurement (see below, section "E" and Chapter 3.18.4 and 3.18.6). Make sure that the ROI is as small as possible. You should choose the ROI such that the center point of the ROI is as close as possible to the expected center point of the circle hole.
- If required, activate the optimized fit and enter a suitable threshold for the optimized fit (see below, section "2").
- If necessary, change the edge threshold (see below, section "2").
- If necessary, change the number of points which are used for detecting the hole (see below, section "2").
- If necessary, choose the projection plane (see below, section "2").
- If applicable, select measured values that are to be used later for calculation, OK/nOK assessment, logging and output (see below, section "H" and Chapter 3.18.9).

Note: Unlike other measuring programs, you have to define a ROI in the "Circular Hole" program in order to obtain valid measurement results.

Note: Unlike other measuring programs, only one ROI can be used in the "Circular Hole" measuring program.

The measuring program outputs the following measured values:

- **Center x:** The X coordinate of the center point of the calculated circle.
- **Center y:** The Y coordinate of the center point of the calculated circle.
- **Center z:** The Z coordinate of the center point of the calculated circle.
- **Radius:** The radius of the calculated circle.
- **Number of points:** The number of edge points that were used to calculate the circle.
- **Sigma:** The standard deviation of the distances between the points that were used to calculate the circle and the calculated circle.
- **Peak to Valley (PV):** The distance between the two points that are furthest away inwards and outwards from the circle, relative to the computed circle. The two points are determined from the points that were used to calculate the circle.

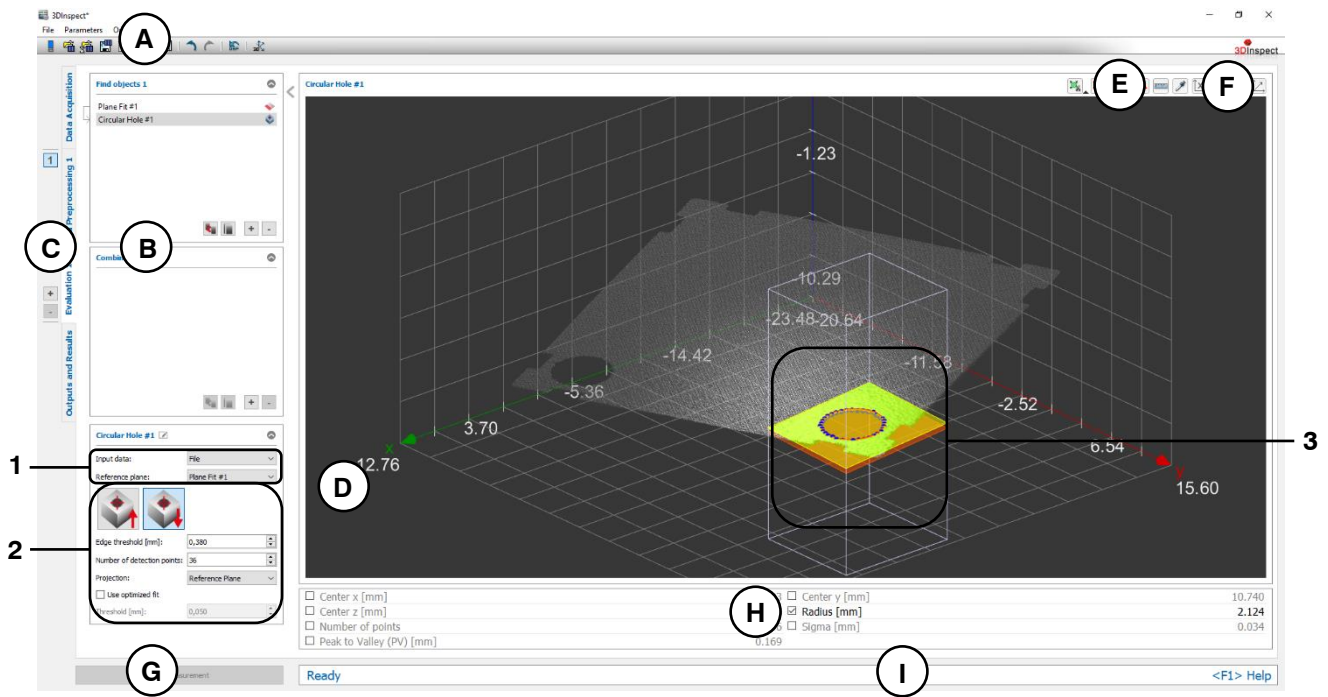

Fig. 6.9: "Circular Hole" Measuring Program

Display Elements and Parameters in the "Circular Hole" Program:

- A "General" toolbar:** Using this toolbar, you can select the data source (see Chapter 3.4 and 3.5), save and load parameters (see Chapter 3.20), reset selected parameters to default settings (see Chapter 3.20.3) and undo and restore changes of settings and parameters (see Chapter 3.21).
 - B List of active measuring programs:** This section displays the active measuring programs from the "Find objects" and "Combine objects" groups. You can add and remove measuring programs/measuring program groups (see Chapter 3.15 and 3.17), move measuring programs (see Chapter 3.16) and select an active measuring program for parameterizing and displaying the measured values.
 - C Measuring program groups / Tab bar for switching between views:** This tab bar allows you to switch between the four main views (see Chapter 3.2). To the left of the tab bar you find the section for adding, removing and selecting measuring program groups (see Chapter 3.17).
 - D 3D-View:** The 3D-View visualizes the 3D data (see Chapter 3.11).
 - E "Measuring" toolbar:** Use this toolbar to set the ROI for the measurement (see Chapter 3.18.4 and 3.18.6).
 - F "3D-View" toolbar:** Use this toolbar to configure the orientation of the coordinate system and activate various options for mouse interaction in the 3D-View (see Chapter 3.11).
 - G "Start measurement" button:** Click on this button to perform a measuring operation, calculate the measurement results and display the point cloud and measurement results of the currently selected measuring program in the 3D-View.
 - H Results display:** The measurement results of the currently selected measuring program are displayed. Here, you can select which measured values are to be made available later for calculation, OK/nOK assessment, logging and output (see Chapter 3.18.9).
 - I Status bar:** Status and error messages are displayed in the status bar (see Chapter 8.1).
- 1 Input data:** Use this selection field to select the reference plane and input point cloud for the program (see also Chapter 3.18.3). An overview of measuring programs, which provide planes, can be found in Chapter 3.19.3.
 - 2 - Search direction:** Specify whether the circular hole is detected up- or downwards the reference plane.

- **Edge threshold [mm]:** This threshold defines the minimum deviation of the surface from the reference plane in order to detect the edge points. If the hole is a countersunk hole, or if 3D points of the hole wall are available in the measurement data, this parameter can be used to alter the position of the calculated edge points relative to the reference plane.
- **Number of detection points:** Specify the number of points for detecting the hole.
- **Projection:** Select whether the edge points are projected and onto which plane. These points will be used for computing the circle fit and the distances for sigma and PV. The points may be projected onto the reference plane or onto the threshold plane which is parallel to the reference plane.
- **Use optimized fit:** When this parameter is activated, an additional preselection of points is applied prior to the circle fit in order to automatically discard outliers or points that do not belong to the circle. The points are selected such that the distances from the resulting circle are less than the predefined threshold and such that the maximum possible number of points is used. Therefore, only the points that best match the circle are used for the circle fit.
The optimized fit is suitable for
 - discarding outlier points/point accumulations during circle fitting
 - considering only the main geometry in the case of small "secondary geometries" presentThe optimized fit is not suitable to achieve improvements within the basic noise of the data.
- **Threshold [mm]:** The threshold for the preselection of the points. Points that deviate from the circle to a smaller degree than the threshold are used for the circle fit. A higher threshold means that more points are used for the circle fit.

3 3D-View: The 3D-View shows the fitted circle (orange). The points that were used to calculate the circle are shown in blue. The input plane is shown in yellow, and the reference plane defined by the input plane and edge threshold is shown in orange.

6.1.8 "Circular Pad" Measuring Program

Use the "Circular Pad" program to measure a circular pad in a point cloud.

Note: The "Circular Pad" program also requires a reference plane in addition to the point cloud as input data. This reference plane can be calculated using the "Plane Fit" (see Chapter 6.1.3) or "Plane Creation" (see Chapter 6.2.7) measuring program.

Proceed as follows:

- First, if you have not already, insert the "Plane Fit" or the "Plane Creation" measuring program and configure the measuring program in order to obtain a reference plane. Please note that you should use the points of the pad for computing the reference plane. Move the measuring program such that it comes before the "Circular Pad" program in the list of active measuring programs (see Chapter 3.16).
- Select the input point cloud and the reference plane for the program (see below, section "1" and Chapter 3.18.3).
- Define a ROI for the pad measurement (see below, section "E" and Chapter 3.18.4 and 3.18.6). Make sure that the ROI is as small as possible. You should choose the ROI such that the center point of the ROI is as close as possible to the expected center point of the circle.
- If required, activate the optimized fit and enter a suitable threshold for the optimized fit (see below, section "2").
- If necessary, change the edge threshold (see below, section "2").
- If necessary, change the number of points which are used for detecting the pad (see below, section "2").
- If necessary, choose the projection plane (see below, section "2").
- If applicable, select measured values that are to be used later for calculation, OK/nOK assessment, logging and output (see below, section "H" and Chapter 3.18.9).

Note: Unlike other measuring programs, you have to define a ROI in the "Circular Pad" program in order to obtain valid measurement results.

Note: Unlike other measuring programs, only one ROI can be used in the "Circular Pad" measuring program.

The measuring program outputs the following measured values:

- **Center x:** The X coordinate of the center point of the calculated circle.
- **Center y:** The Y coordinate of the center point of the calculated circle.
- **Center z:** The Z coordinate of the center point of the calculated circle.
- **Radius:** The radius of the calculated circle.
- **Number of points:** The number of edge points that were used to calculate the circle.
- **Sigma:** The standard deviation of the distances between the points that were used to calculate the circle and the calculated circle.
- **Peak to Valley (PV):** The distance between the two points that are furthest away inwards and outwards from the circle, relative to the computed circle. The two points are determined from the points that were used to calculate the circle.

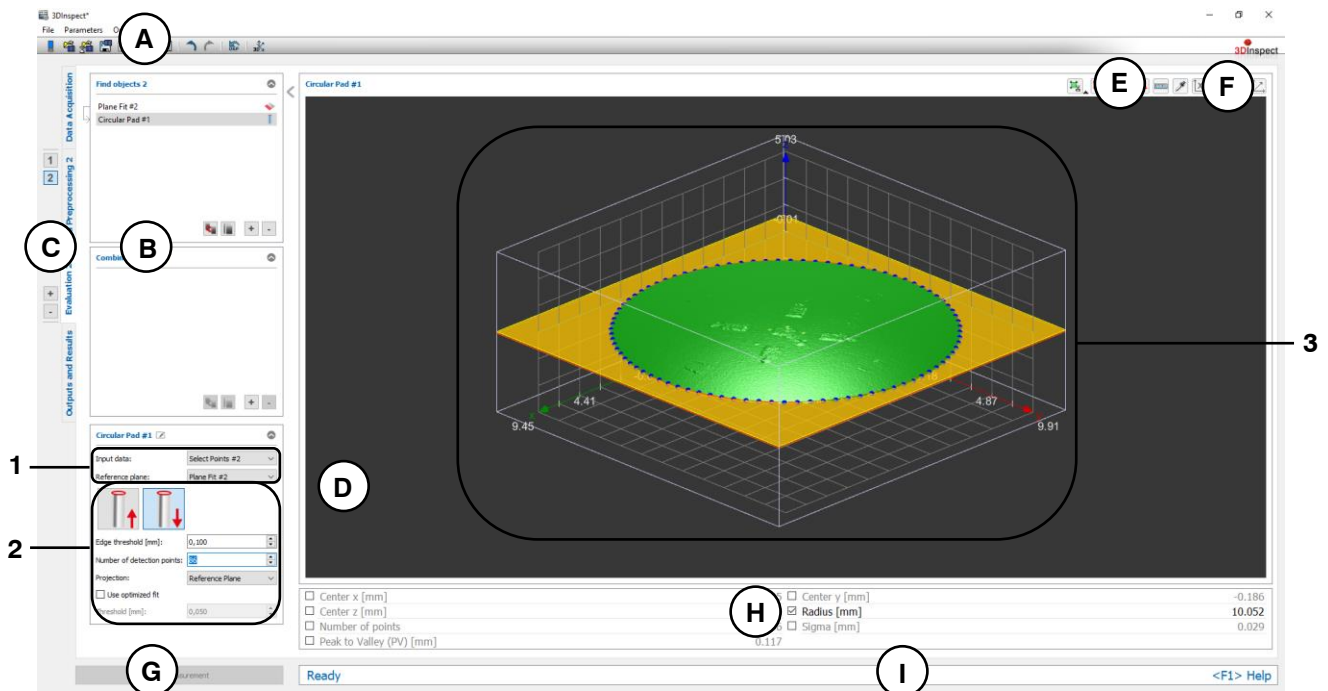

Fig. 6.10: "Circular Pad" Measuring Program

Display Elements and Parameters in the "Circular Pad" Program:

- A "General" toolbar:** Using this toolbar, you can select the data source (see Chapter 3.4 and 3.5), save and load parameters (see Chapter 3.20), reset selected parameters to default settings (see Chapter 3.20.3) and undo and restore changes of settings and parameters (see Chapter 3.21).
- B List of active measuring programs:** This section displays the active measuring programs from the "Find objects" and "Combine objects" groups. You can add and remove measuring programs/measuring program groups (see Chapter 3.15 and 3.17), move measuring programs (see Chapter 3.16) and select an active measuring program for parameterizing and displaying the measured values.
- C Measuring program groups / Tab bar for switching between views:** This tab bar allows you to switch between the four main views (see Chapter 3.2). To the left of the tab bar you find the section for adding, removing and selecting measuring program groups (see Chapter 3.17).
- D 3D-View:** The 3D-View visualizes the 3D data (see Chapter 3.11).
- E "Measuring" toolbar:** Use this toolbar to set the ROI for the measurement (see Chapter 3.18.4 and 3.18.6).
- F "3D-View" toolbar:** Use this toolbar to configure the orientation of the coordinate system and activate various options for mouse interaction in the 3D-View (see Chapter 3.11).
- G "Start measurement" button:** Click on this button to perform a measuring operation, calculate the measurement results and display the point cloud and measurement results of the currently selected measuring program in the 3D-View.

- H Results display:** The measurement results of the currently selected measuring program are displayed. Here, you can select which measured values are to be made available later for calculation, OK/nOK assessment, logging and output (see Chapter 3.18.9).
- I Status bar:** Status and error messages are displayed in the status bar (see Chapter 8.1).
- 1 Input data:** Use this selection field to select the reference plane and input point cloud for the program (see also Chapter 3.18.3). An overview of measuring programs, which provide planes, can be found in Chapter 3.19.3.
- 2**
- **Search direction:** Specify whether the edge points of the circular pad are detected from the face downwards or towards the face upwards.
 - **Edge threshold [mm]:** This threshold defines the minimum deviation of the surface from the reference plane in order to detect the edge points. If the hole is a countersunk hole, or if 3D points of the hole wall are available in the measurement data, this parameter can be used to alter the position of the calculated edge points relative to the reference plane.
 - **Number of detection points:** Specify the number of points for detecting the pad.
 - **Projection:** Select whether the edge points are projected and onto which plane. These points will be used for computing the circle fit and the distances for sigma and PV. The points may be projected onto the reference plane or onto the threshold plane which is parallel to the reference plane.
 - **Use optimized fit:** When this parameter is activated, an additional preselection of points is applied prior to the circle fit in order to automatically discard outliers or points that do not belong to the circle. The points are selected such that the distances from the resulting circle are less than the predefined threshold and such that the maximum possible number of points is used. Therefore, only the points that best match the circle are used for the circle fit.
The optimized fit is suitable for
 - discarding outlier points/point accumulations during circle fitting
 - considering only the main geometry in the case of small "secondary geometries" presentThe optimized fit is not suitable to achieve improvements within the basic noise of the data.
 - **Threshold [mm]:** The threshold for the preselection of the points. Points that deviate from the circle to a smaller degree than the threshold are used for the circle fit. A higher threshold means that more points are used for the circle fit.
- 3 3D-View:** The 3D-View shows the fitted circle (orange). The points that were used to calculate the circle are shown in blue. The input plane is shown in yellow, and the reference plane defined by the input plane and edge threshold is shown in orange.

6.1.9 "Rectangular Hole" Measuring Program

Use the "Rectangular Hole" program to measure a rectangular hole in a point cloud.

Note: The "Rectangular Hole" program also requires a reference plane in addition to the point cloud as input data. This reference plane can be calculated using the "Plane Fit" (see Chapter 6.1.3) or "Plane Creation" (see Chapter 6.2.7) measuring program.

Proceed as follows:

- First, if you have not already, insert the "Plane Fit" or the "Plane Creation" measuring program and configure the measuring program in order to obtain a reference plane. Move the measuring program such that it comes before the "Rectangular Hole" program in the list of active measuring programs (see Chapter 3.16).
- Select the input point cloud and the reference plane for the program (see below, section "1" and Chapter 3.18.3).
- Define a ROI for the hole measurement (see below, section "E" and Chapter 3.18.4 and 3.18.6). Make sure that the ROI is as small as possible. You should choose the ROI such that the center point of the ROI is as close as possible to the expected center point of the rectangle hole.
- If required, activate the optimized fit and enter a suitable threshold for the optimized fit (see below, section "2").
- If necessary, change the edge threshold (see below, section "2").
- If necessary, change the number of points which are used for detecting the hole (see below, section "2").
- If necessary, choose the projection plane (see below, section "2").
- If applicable, select measured values that are to be used later for calculation, OK/nOK assessment, logging and output (see below, section "H" and Chapter 3.18.9).

Note: Unlike other measuring programs, you have to define a ROI in the "Rectangular Hole" program in order to obtain valid measurement results.

Note: Unlike other measuring programs, only one ROI can be used in the "Rectangular Hole" measuring program.

The measuring program outputs the following measured values:

- **Center x:** The X coordinate of the center point of the calculated rectangle.
- **Center y:** The Y coordinate of the center point of the calculated rectangle.
- **Center z:** The Z coordinate of the center point of the calculated rectangle.
- **Width:** The width of the calculated rectangle.
- **Height:** The height of the calculated rectangle.
- **Number of points:** The number of points that were used to calculate the rectangle.
- **Sigma:** The standard deviation of the distances between the points that were used to calculate the rectangle and the calculated rectangle.
- **Peak to Valley (PV):** The distance between the two points that are furthest away inwards and outwards from the rectangle, relative to the computed rectangle. The two points are determined from the points that were used to calculate the rectangle.

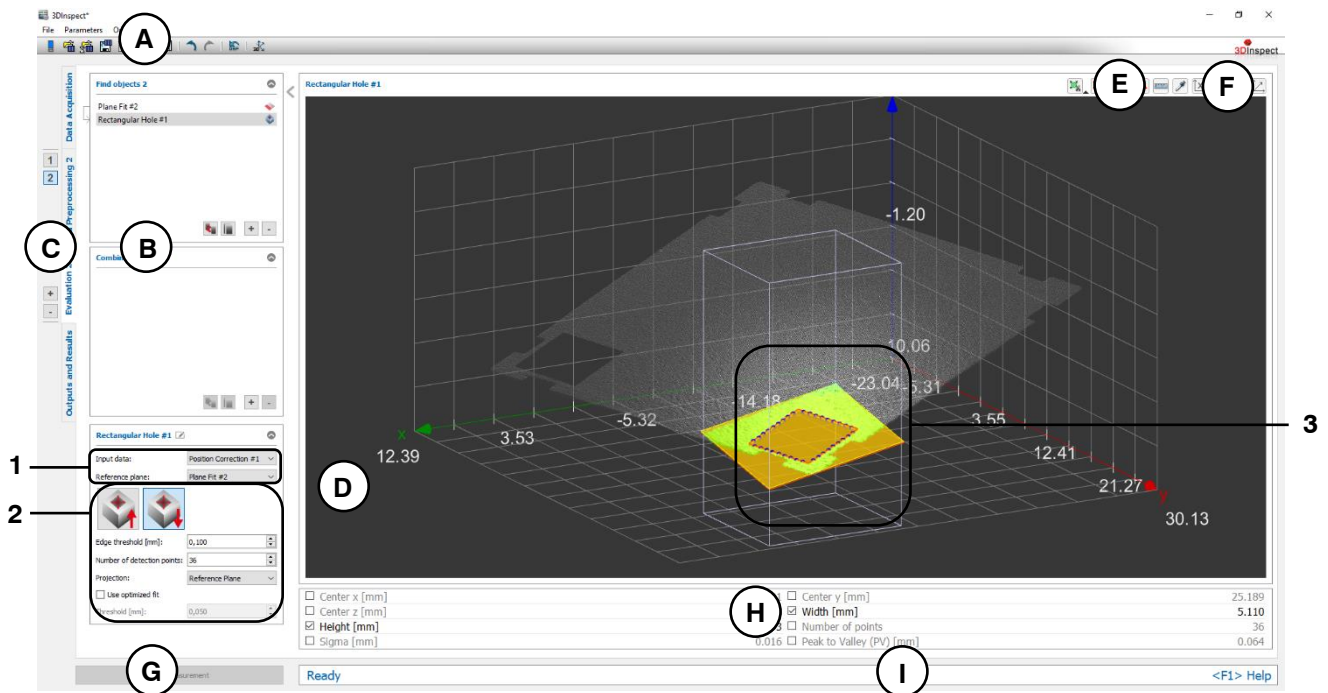

Fig. 6.11: "Rectangular Hole" Measuring Program

Display Elements and Parameters in the "Rectangular Hole" Program:

- A "General" toolbar:** Using this toolbar, you can select the data source (see Chapter 3.4 and 3.5), save and load parameters (see Chapter 3.20), reset selected parameters to default settings (see Chapter 3.20.3) and undo and restore changes of settings and parameters (see Chapter 3.21).
 - B List of active measuring programs:** This section displays the active measuring programs from the "Find objects" and "Combine objects" groups. You can add and remove measuring programs/measuring program groups (see Chapter 3.15 and 3.17), move measuring programs (see Chapter 3.16) and select an active measuring program for parameterizing and displaying the measured values.
 - C Measuring program groups / Tab bar for switching between views:** This tab bar allows you to switch between the four main views (see Chapter 3.2). To the left of the tab bar you find the section for adding, removing and selecting measuring program groups (see Chapter 3.17).
 - D 3D-View:** The 3D-View visualizes the 3D data (see Chapter 3.11).
 - E "Measuring" toolbar:** Use this toolbar to set the ROI for the measurement (see Chapter 3.18.4 and 3.18.6).
 - F "3D-View" toolbar:** Use this toolbar to configure the orientation of the coordinate system and activate various options for mouse interaction in the 3D-View (see Chapter 3.11).
 - G "Start measurement" button:** Click on this button to perform a measuring operation, calculate the measurement results and display the point cloud and measurement results of the currently selected measuring program in the 3D-View.
 - H Results display:** The measurement results of the currently selected measuring program are displayed. Here, you can select which measured values are to be made available later for calculation, OK/nOK assessment, logging and output (see Chapter 3.18.9).
 - I Status bar:** Status and error messages are displayed in the status bar (see Chapter 8.1).
- 1 Input data:** Use this selection field to select the reference plane and input point cloud for the program (see also Chapter 3.18.3). An overview of measuring programs, which provide planes, can be found in Chapter 3.19.3.
 - 2 - Search direction:** Specify whether the circular hole is detected up- or downwards the reference plane.

- **Edge threshold [mm]:** This threshold defines the minimum deviation of the surface from the reference plane in order to detect the edge points. If the hole is a countersunk hole, or if 3D points of the hole wall are available in the measurement data, this parameter can be used to alter the position of the calculated edge points relative to the reference plane.
 - **Number of detection points:** Specify the number of points for detecting the hole.
 - **Projection:** Select whether the edge points are projected and onto which plane. These points will be used for computing the rectangle and the distances for sigma and PV. The points may be projected onto the reference plane or onto the threshold plane which is parallel to the reference plane.
 - **Use optimized fit:** When this parameter is activated, an additional preselection of points is applied prior to the calculated hole in order to automatically discard outliers or points that do not belong to the calculated hole. The points are selected such that the distances from the resulting rectangle are less than the predefined threshold and such that the maximum possible number of points is used. Therefore, only the points that best match are used for the rectangle.
The optimized fit is suitable for
 - discarding outlier points/point accumulations during rectangle fitting
 - considering only the main geometry in the case of small "secondary geometries" presentThe optimized fit is not suitable to achieve improvements within the basic noise of the data.
 - **Threshold [mm]:** The threshold for the preselection of the points. Points that deviate from the rectangle hole to a smaller degree than the threshold are used for the hole. A higher threshold means that more points are used for the hole.
- 3 3D-View:** The 3D-View shows the fitted rectangle hole (orange). The points that were used to calculate the rectangle are shown in blue. The input plane is shown in yellow, and the reference plane defined by the input plane and edge threshold is shown in orange.

6.1.10 "Rectangular Pad" Measuring Program

Use the "Rectangular Pad" program to measure a rectangular pad in a point cloud.

Note: The "Rectangular Pad" program also requires a reference plane in addition to the point cloud as input data. This reference plane can be calculated using the "Plane Fit" (see Chapter 6.1.3) or "Plane Creation" (see Chapter 6.2.7) measuring program.

Proceed as follows:

- First, if you have not already, insert the "Plane Fit" or the "Plane Creation" measuring program and configure the measuring program in order to obtain a reference plane. Please note that you should use the points of the pad for computing the reference plane. Move the measuring program such that it comes before the "Rectangular Pad" program in the list of active measuring programs (see Chapter 3.16).
- Select the input point cloud and the reference plane for the program (see below, section "1" and Chapter 3.18.3).
- Define a ROI for the pad measurement (see below, section "E" and Chapter 3.18.4 and 3.18.6). Make sure that the ROI is as small as possible and completely encloses the pad. You should choose the ROI such that the center point of the ROI is as close as possible to the expected center point of the pad.
- If required, activate the optimized fit and enter a suitable threshold for the optimized fit (see below, section "2").
- If necessary, change the edge threshold (see below, section "2").
- If necessary, change the number of points which are used for detecting the pad (see below, section "2").
- If necessary, choose the projection plane (see below, section "2").
- If applicable, select measured values that are to be used later for calculation, OK/nOK assessment, logging and output (see below, section "H" and Chapter 3.18.9).

Note: Unlike other measuring programs, you have to define a ROI in the "Rectangular Pad" program in order to obtain valid measurement results.

Note: Unlike other measuring programs, only one ROI can be used in the "Rectangular Pad" measuring program.

The measuring program outputs the following measured values:

- **Center x:** The X coordinate of the center point of the pad.
- **Center y:** The Y coordinate of the center point of the pad.
- **Center z:** The Z coordinate of the center point of the pad.
- **Width:** The width of the pad.
- **Height:** The height of the pad.
- **Number of points:** The number of edge points that were used to calculate the pad.
- **Sigma:** The standard deviation of the distances between the points that were used to calculate the pad and the respective edge of the pad.
- **Peak to Valley (PV):** The distance between the two points that are furthest away inwards and outwards from the respective edge, relative to the respective edge. The two points are determined from the points that were used to calculate the pad.

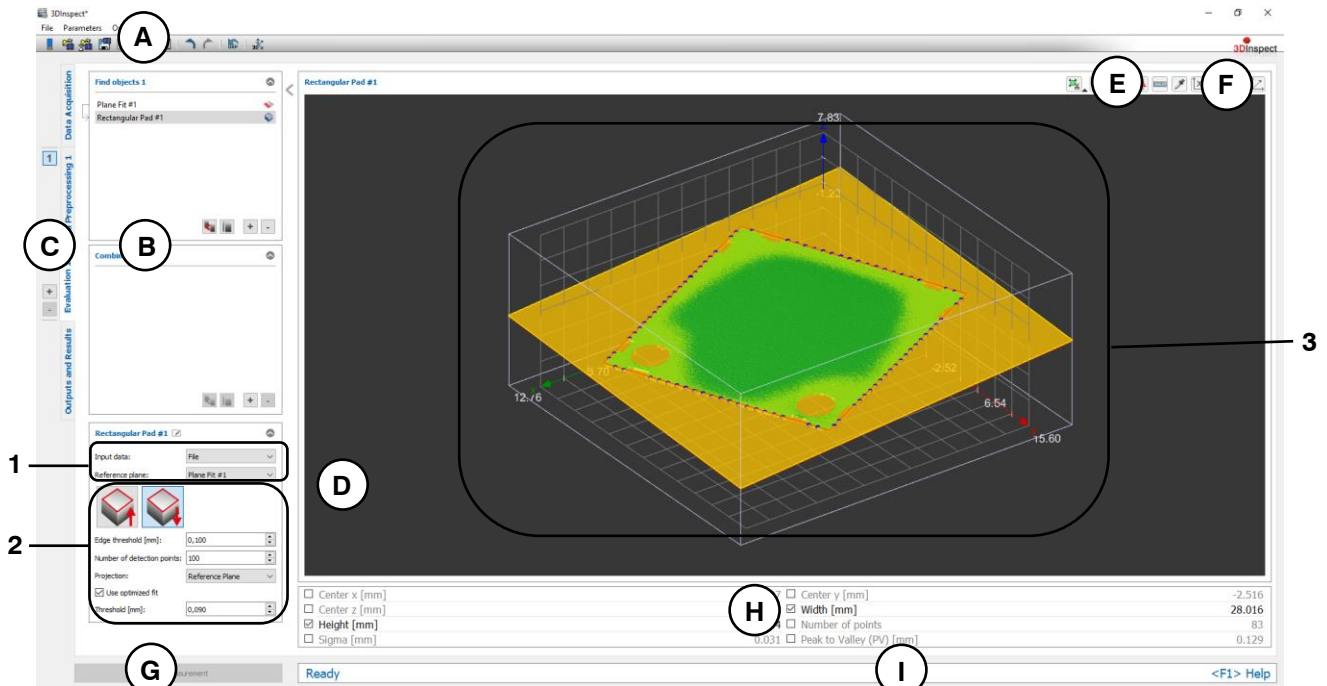

Fig. 6.12: "Rectangular Pad" Measuring Program

Display Elements and Parameters in the "Rectangular Pad" Program:

- A "General" toolbar:** Using this toolbar, you can select the data source (see Chapter 3.4 and 3.5), save and load parameters (see Chapter 3.20), reset selected parameters to default settings (see Chapter 3.20.3) and undo and restore changes of settings and parameters (see Chapter 3.21).
- B List of active measuring programs:** This section displays the active measuring programs from the "Find objects" and "Combine objects" groups. You can add and remove measuring programs/measuring program groups (see Chapter 3.15 and 3.17), move measuring programs (see Chapter 3.16) and select an active measuring program for parameterizing and displaying the measured values.
- C Measuring program groups / Tab bar for switching between views:** This tab bar allows you to switch between the four main views (see Chapter 3.2). To the left of the tab bar you find the section for adding, removing and selecting measuring program groups (see Chapter 3.17).
- D 3D-View:** The 3D-View visualizes the 3D data (see Chapter 3.11).
- E "Measuring" toolbar:** Use this toolbar to set the ROI for the measurement (see Chapter 3.18.4 and 3.18.6).
- F "3D-View" toolbar:** Use this toolbar to configure the orientation of the coordinate system and activate various options for mouse interaction in the 3D-View (see Chapter 3.11).

- G** **"Start measurement" button:** Click on this button to perform a measuring operation, calculate the measurement results and display the point cloud and measurement results of the currently selected measuring program in the 3D-View.
- H** **Results display:** The measurement results of the currently selected measuring program are displayed. Here, you can select which measured values are to be made available later for calculation, OK/nOK assessment, logging and output (see Chapter 3.18.9).
- I** **Status bar:** Status and error messages are displayed in the status bar (see Chapter 8.1).
- 1** **Input data:** Use this selection field to select the reference plane and input point cloud for the program (see also Chapter 3.18.3). An overview of measuring programs, which provide planes, can be found in Chapter 3.19.3.
- 2**
- **Search direction:** Specify whether the edge points of the circular pad are detected from the face downwards or towards the face upwards.
 - **Edge threshold [mm]:** This threshold defines the minimum deviation of the surface from the reference plane in order to detect the edge points. If the edges are skewed or if 3D points of the side walls of the pad are available in the measurement data, this parameter can be used to alter the position of the calculated edge points relative to the reference plane.
 - **Number of detection points:** Specify the number of points for detecting the pad.
 - **Projection:** Select whether the edge points are projected and onto which plane. These points will be used for computing the pad and the distances for sigma and PV. The points may be projected onto the reference plane or onto the threshold plane which is parallel to the reference plane.
 - **Use optimized fit:** When this parameter is activated, an additional preselection of points is applied prior to the pad computation in order to automatically discard outliers or points that do not belong to the pad. The points are selected such that the distances from the resulting pad are less than the predefined threshold and such that the maximum possible number of points is used. Therefore, only the points that best match the pad are used for the rectangle pad. The optimized fit is suitable for
 - discarding outlier points/point accumulations during rectangle fitting
 - considering only the main geometry in the case of small "secondary geometries" presentThe optimized fit is not suitable to achieve improvements within the basic noise of the data.
 - **Threshold [mm]:** The threshold for the preselection of the points. Points that deviate from the pad to a smaller degree than the threshold are used for the rectangular pad computation. A higher threshold means that more points are used for the pad.
- 3** **3D-View:** The 3D-View shows the fitted pad (orange). The points that were used to calculate the pad are shown in blue. The input plane is shown in yellow, and the reference plane defined by the input plane and edge threshold is shown in orange.

6.1.11 "Edge" Measuring Program

Use the "Edge" program to measure a straight edge in a point cloud.

Note: The "Edge" program also requires a reference plane in addition to the point cloud as input data. This reference plane can be calculated using the "Plane Fit" (see Chapter 6.1.3) or "Plane Creation" (see Chapter 6.2.7) measuring program.

Proceed as follows:

- First, if you have not already, insert the "Plane Fit" or the "Plane Creation" measuring program and configure the measuring program in order to obtain a reference plane. Move the measuring program such that it comes before the "Edge" program in the list of active measuring programs (see Chapter 3.16).
- Select the input point cloud and the reference plane for the program (see below, section "1" and Chapter 3.18.3).
- Define a ROI for the edge measurement (see below, section "E" and Chapter 3.18.4 and 3.18.6). Make sure that the ROI is as small as possible. You should choose the ROI such that the center point of the ROI is as close as possible to the expected center point of the edge and such that exactly one edge is in the ROI.
- If required, activate the optimized fit and enter a suitable threshold for the optimized fit (see below, section "2").
- If necessary, change the edge threshold (see below, section "2").
- If necessary, change the number of points which are used for detecting the edge (see below, section "2").
- If necessary, choose the projection plane (see below, section "2").
- If applicable, select measured values that are to be used later for calculation, OK/nOK assessment, logging and output (see below, section "H" and Chapter 3.18.9).

Note: Unlike other measuring programs, you have to define a ROI in the "Edge" program in order to obtain valid measurement results.

Note: Unlike other measuring programs, only one ROI can be used in the "Edge" measuring program.

The measuring program outputs the following measured values:

- **Line angle to x/y plane:** The angle of the edge with respect to the X/Y plane.
- **Line angle to y/z plane:** The angle of the edge with respect to the Y/Z plane.
- **Line angle to z/x plane:** The angle of the edge with respect to the Z/X plane.
- **Center x:** The X coordinate of the center point of the points which has been used to calculate the edge.
- **Center y:** The Y coordinate of the center point of the points which has been used to calculate the edge.
- **Center z:** The Z coordinate of the center point of the points which has been used to calculate the edge.
- **Number of points:** The number points that were used to calculate the edge.
- **Sigma:** The standard deviation of the distances between the points that were used to calculate the edge and the calculated edge.
- **Peak to Valley (PV):** The distance between the two points that are furthest away inwards and outwards from the edge, relative to the computed edge. The two points are determined from the points that were used to calculate the edge.

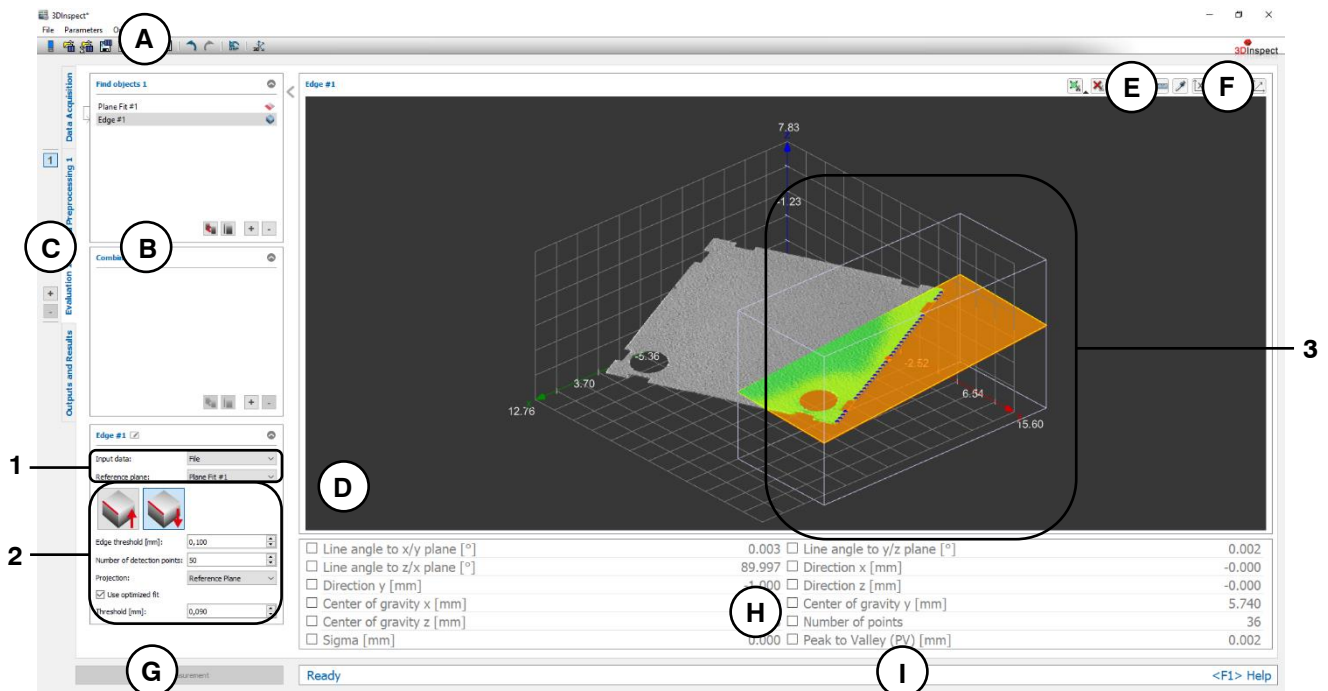

Fig. 6.13: "Edge" Measuring Program

Display Elements and Parameters in the "Edge" Program:

- A "General" toolbar:** Using this toolbar, you can select the data source (see Chapter 3.4 and 3.5), save and load parameters (see Chapter 3.20), reset selected parameters to default settings (see Chapter 3.20.3) and undo and restore changes of settings and parameters (see Chapter 3.21).
- B List of active measuring programs:** This section displays the active measuring programs from the "Find objects" and "Combine objects" groups. You can add and remove measuring programs/measuring program groups (see Chapter 3.15 and 3.17), move measuring programs (see Chapter 3.16) and select an active measuring program for parameterizing and displaying the measured values.
- C Measuring program groups / Tab bar for switching between views:** This tab bar allows you to switch between the four main views (see Chapter 3.2). To the left of the tab bar you find the section for adding, removing and selecting measuring program groups (see Chapter 3.17).
- D 3D-View:** The 3D-View visualizes the 3D data (see Chapter 3.11).
- E "Measuring" toolbar:** Use this toolbar to set the ROI for the measurement (see Chapter 3.18.4 and 3.18.6).
- F "3D-View" toolbar:** Use this toolbar to configure the orientation of the coordinate system and activate various options for mouse interaction in the 3D-View (see Chapter 3.11).
- G "Start measurement" button:** Click on this button to perform a measuring operation, calculate the measurement results and display the point cloud and measurement results of the currently selected measuring program in the 3D-View.
- H Results display:** The measurement results of the currently selected measuring program are displayed. Here, you can select which measured values are to be made available later for calculation, OK/nOK assessment, logging and output (see Chapter 3.18.9).
- I Status bar:** Status and error messages are displayed in the status bar (see Chapter 8.1).
- 1 Input data:** Use this selection field to select the reference plane and input point cloud for the program (see also Chapter 3.18.3). An overview of measuring programs, which provide planes, can be found in Chapter 3.19.3.
- 2 - Search direction:** Select whether the edge is up- or downwards the reference plane.

- **Edge threshold [mm]:** This threshold defines the minimum deviation of the surface from the reference plane in order to detect the edge points. If the edge is skewed or if 3D points of the side wall of the object are available in the measurement data, this parameter can be used to alter the position of the calculated edge points relative to the reference plane.
 - **Number of detection points:** Specify the number of points for detecting the edge.
 - **Projection:** Select whether the edge points are projected and onto which plane. These points will be used for computing the edge fit and the distances for sigma and PV. The points may be projected onto the reference plane or onto the threshold plane which is parallel to the reference plane.
 - **Use optimized fit:** When this parameter is activated, an additional preselection of points is applied prior to the edge fit in order to automatically discard outliers or points that do not belong to the edge. The points are selected such that the distances from the resulting edge are less than the predefined threshold and such that the maximum possible number of points is used. Therefore, only the points that best match the edge are used for the edge fit.
The optimized fit is suitable for
 - discarding outlier points/point accumulations during edge fitting
 - considering only the main geometry in the case of small "secondary geometries" presentThe optimized fit is not suitable to achieve improvements within the basic noise of the data.
 - **Threshold [mm]:** The threshold for the preselection of the points. Points that deviate from the edge to a smaller degree than the threshold are used for the edge fit. A higher threshold means that more points are used for the edge fit.
- 3 3D-View:** The 3D-View shows the fitted edge (orange). The points that were used to calculate the edge are shown in blue. The input plane is shown in yellow, and the reference plane defined by the input plane and edge threshold is shown in orange.

6.1.12 "Seam" Measuring Program

Use the "Seam" program to measure a seam in a point cloud. All points that lie above the threshold plane defined by the X/Y plane and the threshold value are used to detect the seam.

Note: The "Seam" program requires an equidistant default grid (= x and y axis). Use the "Resampling" program (see Chapter 5.1.8) to create a point cloud with an equidistant grid when needed.

Proceed as follows:

- Select the input point cloud for the program (see below, section "1" and Chapter 3.18.3).
- Define a ROI for the seam measurement (see below, section "E" and Chapter 3.18.4 and 3.18.6).
- Specify an adequate threshold for detecting the seam (see below, section "2").
- If applicable, select measured values that are to be used later for calculation, OK/nOK assessment, logging and output (see below, section "H" and Chapter 3.18.9).

The measuring program outputs the following measured values:

- **Volume:** The volume of the measured seam related to the X/Y plane.
- **Area:** The area of the measured seam related to the X/Y plane.
- **Height:** The height of the measured seam related to the X/Y plane.
- **Number of points:** The number of points of the measured seam.
- **Maximum point x:** The X coordinate of the maximum point of the measured seam.
- **Maximum point y:** The Y coordinate of the maximum point of the measured seam.
- **Maximum point z:** The Z coordinate of the maximum point of the measured seam.

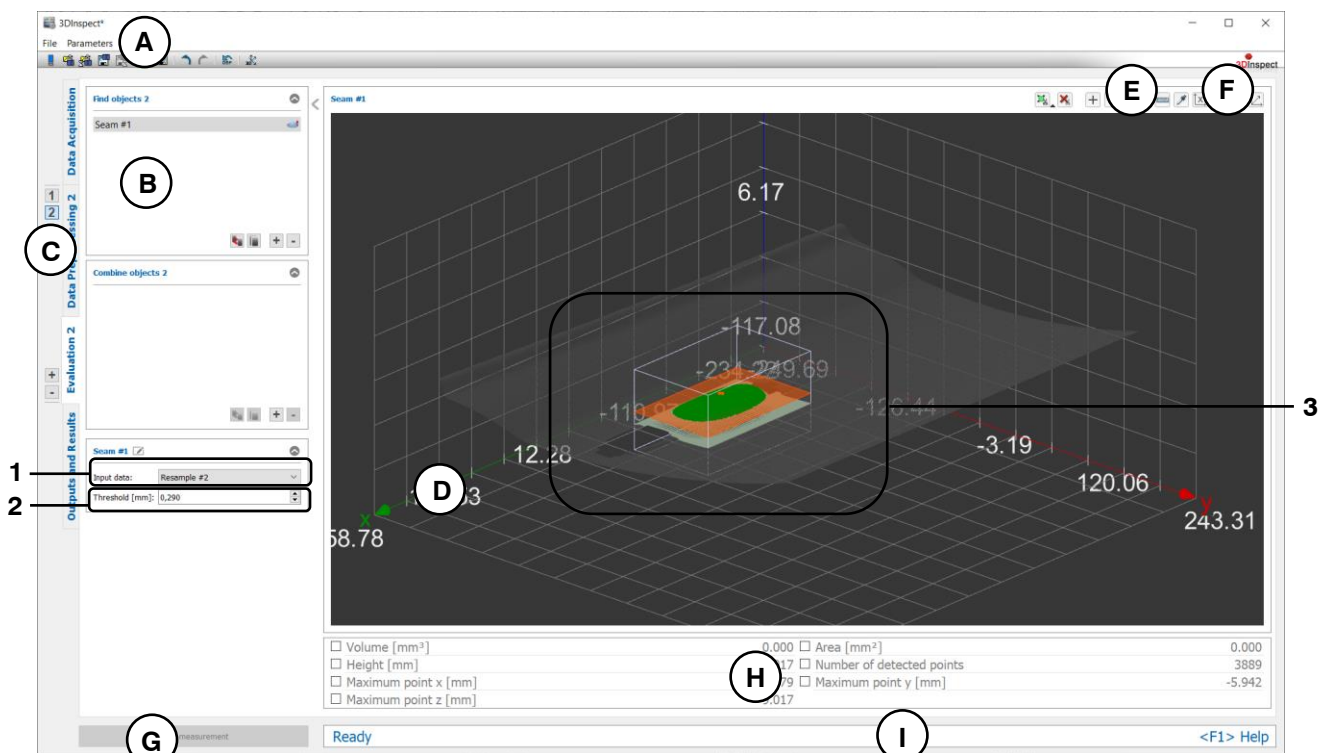

Fig. 6.14: "Seam" Measuring Program

Display Elements and Parameters in the "Seam" Program:

- A "General" toolbar:** Using this toolbar, you can select the data source (see Chapter 3.4 and 3.5), save and load parameters (see Chapter 3.20), reset selected parameters to default settings (see Chapter 3.20.3) and undo and restore changes of settings and parameters (see Chapter 3.21).
- B List of active measuring programs:** This section displays the active measuring programs from the "Find objects" and "Combine objects" groups. You can add and remove measuring programs/measuring program groups (see Chapter 3.15 and 3.17), move measuring programs

(see Chapter 3.16) and select an active measuring program for parameterizing and displaying the measured values.

- C Measuring program groups / Tab bar for switching between views:** This tab bar allows you to switch between the four main views (see Chapter 3.2). To the left of the tab bar you find the section for adding, removing and selecting measuring program groups (see Chapter 3.17).
 - D 3D-View:** The 3D-View visualizes the 3D data (see Chapter 3.11).
 - E "Measuring" toolbar:** Use this toolbar to set the ROI for the measurement (see Chapter 3.18.4 and 3.18.6).
 - F "3D-View" toolbar:** Use this toolbar to configure the orientation of the coordinate system and activate various options for mouse interaction in the 3D-View (see Chapter 3.11).
 - G "Start measurement" button:** Click on this button to perform a measuring operation, calculate the measurement results and display the point cloud and measurement results of the currently selected measuring program in the 3D-View.
 - H Results display:** The measurement results of the currently selected measuring program are displayed. Here, you can select which measured values are to be made available later for calculation, OK/nOK assessment, logging and output (see Chapter 3.18.9).
 - I Status bar:** Status and error messages are displayed in the status bar (see Chapter 8.1).
-
- 1 Input data:** Use this selection field to select the input point cloud for the program (see also Chapter 3.18.3).
 - 2 Threshold [mm]:** This threshold defines the minimum deviation of the surface to the X/Y plane to detect the points.
 - 3 3D-View:** The points that were used to measure the seam are shown in green. The threshold plane defined by the X/Y plane and the threshold value is displayed in orange. In addition, the maximum point is shown in the 3D display.

6.1.13 "Groove" Measuring Program

Use the "Groove" program to measure a groove in a point cloud. All points that lie below the threshold plane defined by the X/Y plane and the threshold value are used to detect the groove.

Note: The "Groove" program requires an equidistant default grid (= x and y axis). Use the "Resampling" program (see Chapter 5.1.8) to create a point cloud with an equidistant grid when needed.

Proceed as follows:

- Select the input point cloud for the program (see below, section "1" and Chapter 3.18.3).
- Define a ROI for the seam measurement (see below, section "E" and Chapter 3.18.4 and 3.18.6).
- Specify an adequate threshold for detecting the groove (see below, section "2").
- If applicable, select measured values that are to be used later for calculation, OK/nOK assessment, logging and output (see below, section "H" and Chapter 3.18.9).

The measuring program outputs the following measured values:

- **Volume:** The volume of the measured groove related to the X/Y plane.
- **Area:** The area of the measured groove related to the X/Y plane.
- **Depth:** The depth of the measured groove related to the X/Y plane.
- **Number of points:** The number of points of the measured groove.
- **Minimum point x:** The X coordinate of the minimum point of the measured groove.
- **Minimum point y:** The Y coordinate of the minimum point of the measured groove.
- **Minimum point z:** The Z coordinate of the minimum point of the measured groove.

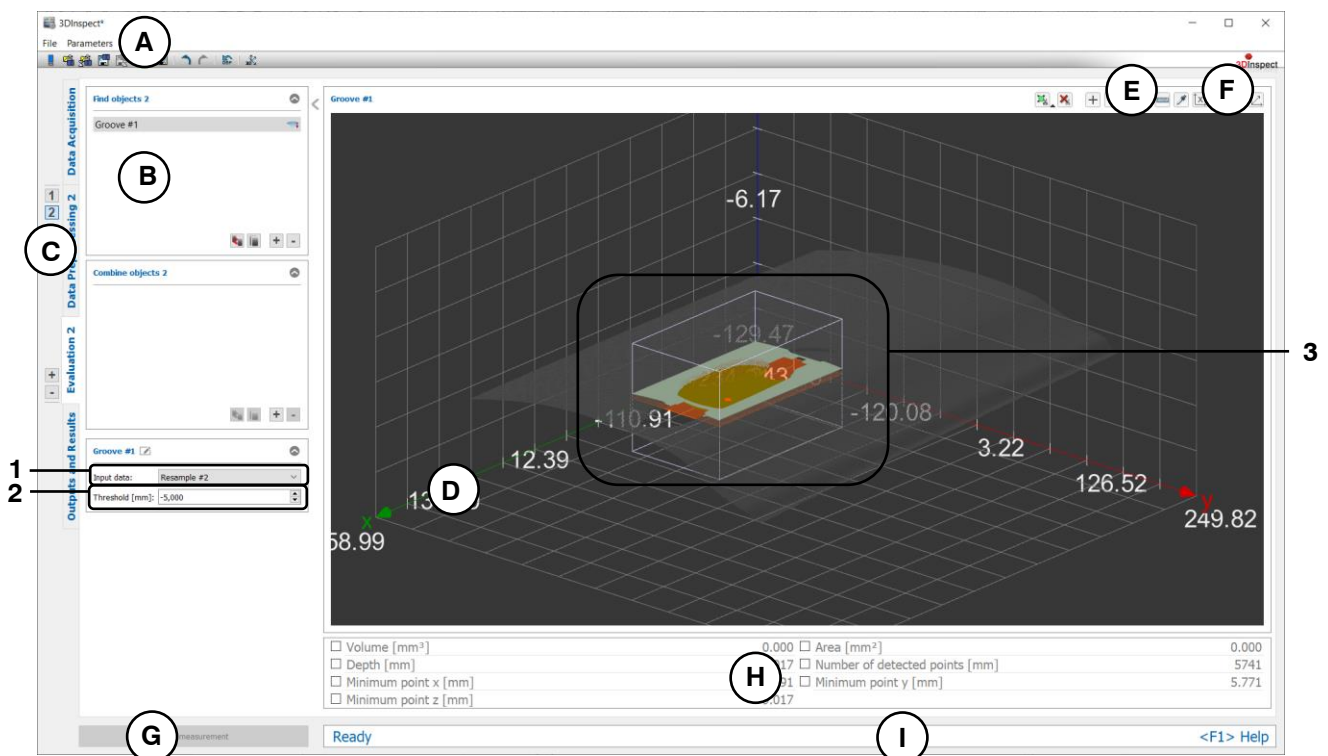

Fig. 6.15: "Groove" Measuring Program

Display Elements and Parameters in the "Groove" Program:

- A "General" toolbar:** Using this toolbar, you can select the data source (see Chapter 3.4 and 3.5), save and load parameters (see Chapter 3.20), reset selected parameters to default settings (see Chapter 3.20.3) and undo and restore changes of settings and parameters (see Chapter 3.21).
- B List of active measuring programs:** This section displays the active measuring programs from the "Find objects" and "Combine objects" groups. You can add and remove measuring programs/measuring program groups (see Chapter 3.15 and 3.17), move measuring programs

- (see Chapter 3.16) and select an active measuring program for parameterizing and displaying the measured values.
- C Measuring program groups / Tab bar for switching between views:** This tab bar allows you to switch between the four main views (see Chapter 3.2). To the left of the tab bar you find the section for adding, removing and selecting measuring program groups (see Chapter 3.17).
 - D 3D-View:** The 3D-View visualizes the 3D data (see Chapter 3.11).
 - E "Measuring" toolbar:** Use this toolbar to set the ROI for the measurement (see Chapter 3.18.4 and 3.18.6).
 - F "3D-View" toolbar:** Use this toolbar to configure the orientation of the coordinate system and activate various options for mouse interaction in the 3D-View (see Chapter 3.11).
 - G "Start measurement" button:** Click on this button to perform a measuring operation, calculate the measurement results and display the point cloud and measurement results of the currently selected measuring program in the 3D-View.
 - H Results display:** The measurement results of the currently selected measuring program are displayed. Here, you can select which measured values are to be made available later for calculation, OK/nOK assessment, logging and output (see Chapter 3.18.9).
 - I Status bar:** Status and error messages are displayed in the status bar (see Chapter 8.1).
- 1 Input data:** Use this selection field to select the input point cloud for the program (see also Chapter 3.18.3).
 - 2 Threshold [mm]:** This threshold defines the minimum deviation of the surface to the X/Y plane to detect the points.
 - 3 3D-View:** The points that were used to measure the groove are shown in green. The threshold plane defined by the X/Y plane and the threshold value is displayed in orange. In addition, the minimum point is shown in the 3D display.

6.1.14 "QR Code" Measuring Program

Use the "QR Code" program to read a QR Code from a 3D point cloud.

Note: The "QR Code" measuring program detects QR codes with the size 29x29 that are characterized by height differences in the measurement data. The black marked pixels must be lower than the white marked pixels. Printed QR codes that are characterized by intensity differences cannot be detected.

Proceed as follows:

- If applicable, select the input data for the program (see below, section "1" and Chapter 3.18.3).
- If necessary, limit the reading range in order to eliminate interfering points (see section "E" and Chapter 3.18.4, 3.18.6 and 3.18.7).
- If required, activate or deactivate the "Flatten surface" option (see below, section "2").
- If applicable, select detected message that are to be used later for logging and output (see below, section "H" and Chapter 3.18.9).

The measuring program outputs the following measured values:

- **Decoded message:** The decoded message of the QR Code.

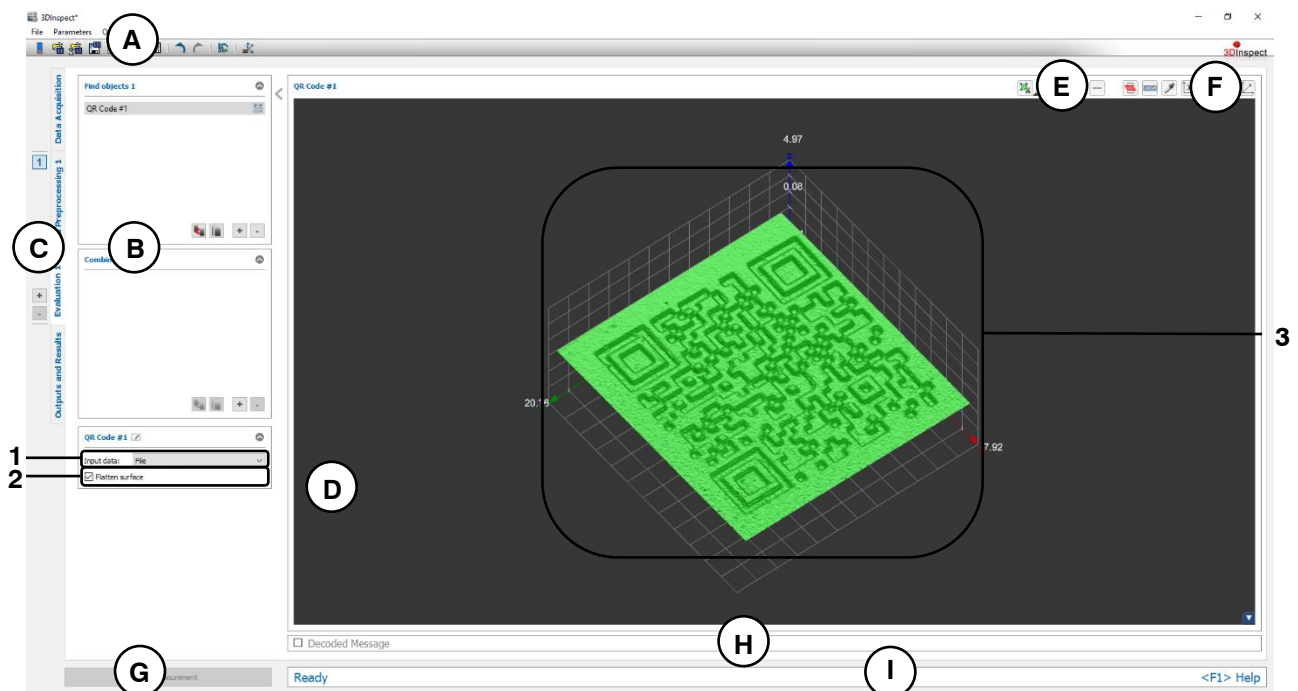

Fig. 6.16: "QR Code" Measuring Program

Display Elements and Parameters in the "QR Code" Program:

- A "General" toolbar:** Using this toolbar, you can select the data source (see Chapter 3.4 and 3.5), save and load parameters (see Chapter 3.20), reset selected parameters to default settings (see Chapter 3.20.3) and undo and restore changes of settings and parameters (see Chapter 3.21).
- B List of active measuring programs:** This section displays the active measuring programs from the "Find objects" and "Combine objects" groups. You can add and remove measuring programs/measuring program groups (see Chapter 3.15 and 3.17), move measuring programs (see Chapter 3.16) and select an active measuring program for parameterizing and displaying the measured values.
- C Measuring program groups / Tab bar for switching between views:** This tab bar allows you to switch between the four main views (see Chapter 3.2). To the left of the tab bar you find the section for adding, removing and selecting measuring program groups (see Chapter 3.17).
- D 3D-View:** The 3D-View visualizes the 3D data (see Chapter 3.11).

- E** **"Measuring" toolbar:** Use this toolbar to set various ROIs for the measurement (see Chapter [3.18.4](#), [3.18.6](#) and [3.18.7](#)).
 - F** **"3D-View" toolbar:** Use this toolbar to configure the orientation of the coordinate system and activate various options for mouse interaction in the 3D-View (see Chapter [3.11](#)).
 - G** **"Start measurement" button:** Click on this button to perform a measuring operation, calculate the measurement results and display the point cloud and measurement results of the currently selected measuring program in the 3D-View.
 - H** **Results display:** The measurement results of the currently selected measuring program are displayed. Here, you can select which measured values are to be made available later for calculation, OK/nOK assessment, logging and output (see Chapter [3.18.9](#)).
 - I** **Status bar:** Status and error messages are displayed in the status bar (see Chapter [8.1](#)).
-
- 1** **Input data:** Use this selection field to select the input data for the program (see also Chapter [3.18.3](#)).
 - 2** **Flatten surface:** The selected area will be approximated to a plane. This option is required for curved surfaces.
 - 3** **3D-View:** The 3D-View visualizes the points that are used to detect the QR Code in green. The discarded points are shown in gray.

6.1.15 "Center of Gravity 2D" Measuring Program

Use the "Center of Gravity 2D" program to calculate the center of gravity of 2D points.

Note: The "Center of Gravity 2D" program needs a 2D profile as input data. The "Profile Section" measuring program can be used in order to generate a 2D profile. (see Chapter 5.1.19)

Proceed as follows:

- If applicable, select the input data for the program (see below, section "1" and Chapter 3.18.3).
- If necessary, limit the range for the center of gravity calculation in order to eliminate interfering points (see section "E" and Chapter 3.18.5, 3.18.6 and 3.18.7).
- If applicable, select measured values that are to be used later for calculation, OK/nOK assessment, logging and output (see below, section "H" and Chapter 3.18.9).

Depending on the selected parameter "Result format" (see below, section "2") the measuring program outputs the following measured values:

- **Center of gravity x:** The X coordinate of the calculated center of gravity in the three dimensional space.
- **Center of gravity y:** The Y coordinate of the calculated center of gravity in the three dimensional space.
- **Center of gravity z:** The Z coordinate of the calculated center of gravity in the three dimensional space.
- **Center of gravity u:** The U coordinate of the calculated center of gravity in the two dimensional space.
- **Center of gravity v:** The V coordinate of the calculated center of gravity in the two dimensional space.
- **Number of points:** The number of selected points in the current profile that were used to calculate the center of gravity.
- **Sigma:** The standard deviation of the distances of the points to the center of gravity.

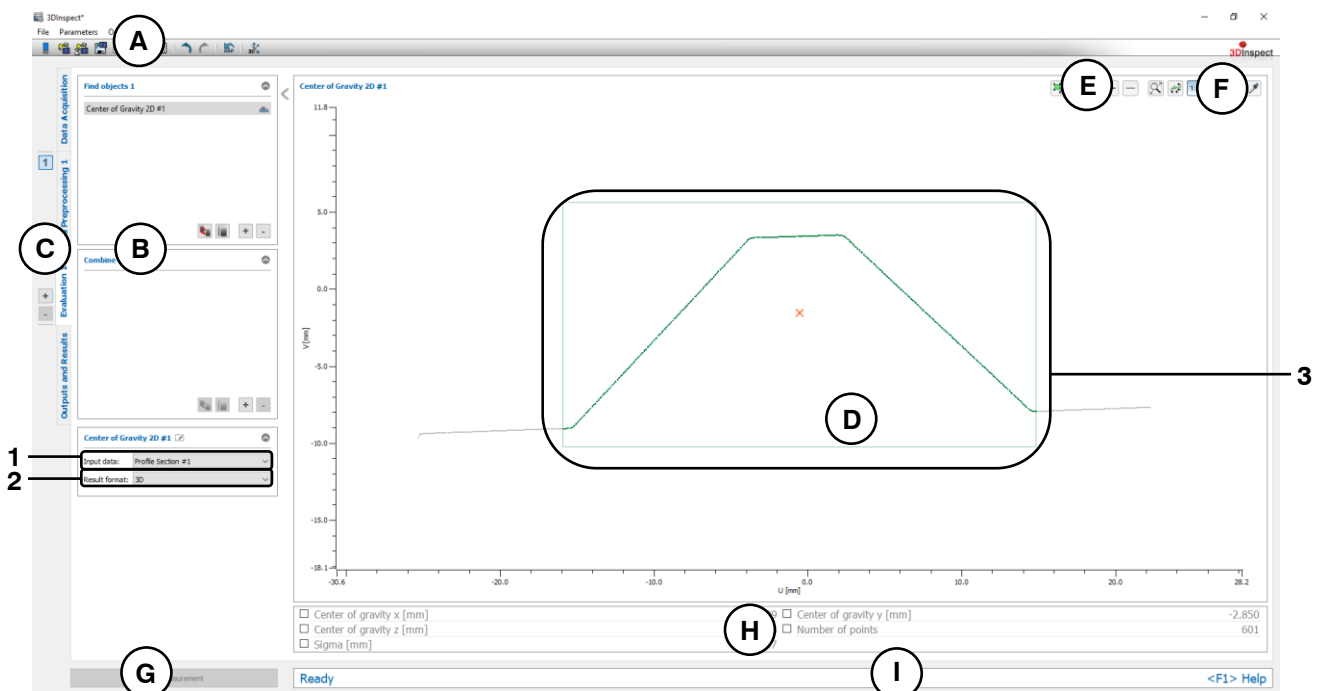

Fig. 6.17: "Center of Gravity 2D" Measuring Program

Display Elements and Parameters in the "Center of Gravity 2D" Program:

- A** **"General" toolbar:** Using this toolbar, you can select the data source (see Chapter 3.4 and 3.5), save and load parameters (see Chapter 3.20), reset selected parameters to default settings (see Chapter 3.20.3) and undo and restore changes of settings and parameters (see Chapter 3.21).

- B List of active measuring programs:** This section displays the active measuring programs from the "Find objects" and "Combine objects" groups. You can add and remove measuring programs/measuring program groups (see Chapter 3.15 and 3.17), move measuring programs (see Chapter 3.16) and select an active measuring program for parameterizing and displaying the measured values.
 - C Measuring program groups / Tab bar for switching between views:** This tab bar allows you to switch between the four main views (see Chapter 3.2). To the left of the tab bar you find the section for adding, removing and selecting measuring program groups (see Chapter 3.17).
 - D 2D Profile View:** The 2D Profile View visualizes the 2D data (see Chapter 3.13).
 - E "Measuring" toolbar:** Use this toolbar to set various ROIs for the measurement (see Chapter 3.18.5, 3.18.6 and 3.18.7).
 - F "2D Profile View" toolbar:** Use this toolbar to scale the 2D Profile View and activate various options for mouse interaction (see Chapter 3.13).
 - G "Start measurement" button:** Click on this button to perform a measuring operation, calculate the measurement results and display the profile and measurement results of the currently selected measuring program in the 2D Profile View.
 - H Results display:** The measurement results of the currently selected measuring program are displayed. Here, you can select which measured values are to be made available later for calculation, OK/nOK assessment, logging and output (see Chapter 3.18.9).
 - I Status bar:** Status and error messages are displayed in the status bar (see Chapter 8.1).
- 1 Input data:** Use this selection field to select the input data for the program (see also Chapter 3.18.3).
 - 2 Result format:** Choose whether the measured values are to be output in the two or three dimensional space. This affects the results display, the calculating, assessing, logging and output of the measured values.
 - 3 2D Profile View:** The calculated center of gravity is displayed as an orange point in the 2D Profile View. The points that were used to calculate the center of gravity (green) and the discarded points (gray) are displayed.

6.1.16 "Extreme Point 2D" Measuring Program

Use the "Extreme Point 2D" program to determine extreme points of 2D points.

Note: The "Extreme Point 2D" program needs a 2D profile as input data. The "Profile Section" measuring program can be used in order to generate a 2D profile. (see Chapter 5.1.19)

Proceed as follows:

- If applicable, select the input data for the program (see below, section "1" and Chapter 3.18.3).
- If necessary, limit the range for determining the extreme points in order to eliminate interfering points (see section "E" and Chapter 3.18.5, 3.18.6 and 3.18.7).
- Select the direction of the extreme points to be determined (see below, section "2").
- If applicable, select measured values that are to be used later for calculation, OK/nOK assessment, logging and output (see below, section "H" and Chapter 3.18.9).

Depending on the selected parameter "Result format" (see below, section "2") the measuring program outputs the following measured values:

- **Minimum point x:** The X coordinate of the minimum point in the three dimensional space.
- **Minimum point y:** The Y coordinate of the minimum point in the three dimensional space.
- **Minimum point z:** The Z coordinate of the minimum point in the three dimensional space.
- **Maximum point x:** The X coordinate of the maximum point in the three dimensional space.
- **Maximum point y:** The Y coordinate of the maximum point in the three dimensional space.
- **Maximum point z:** The Z coordinate of the maximum point in the three dimensional space.
- **Minimum point u:** The U coordinate of the minimum point in the two dimensional space.
- **Minimum point v:** The V coordinate of the minimum point in the two dimensional space.
- **Maximum point u:** The U coordinate of the maximum point in the two dimensional space.
- **Maximum point v:** The V coordinate of the maximum point in the two dimensional space.
- **Number of points:** The number of selected points in the current profile that were used to determine the extreme points.

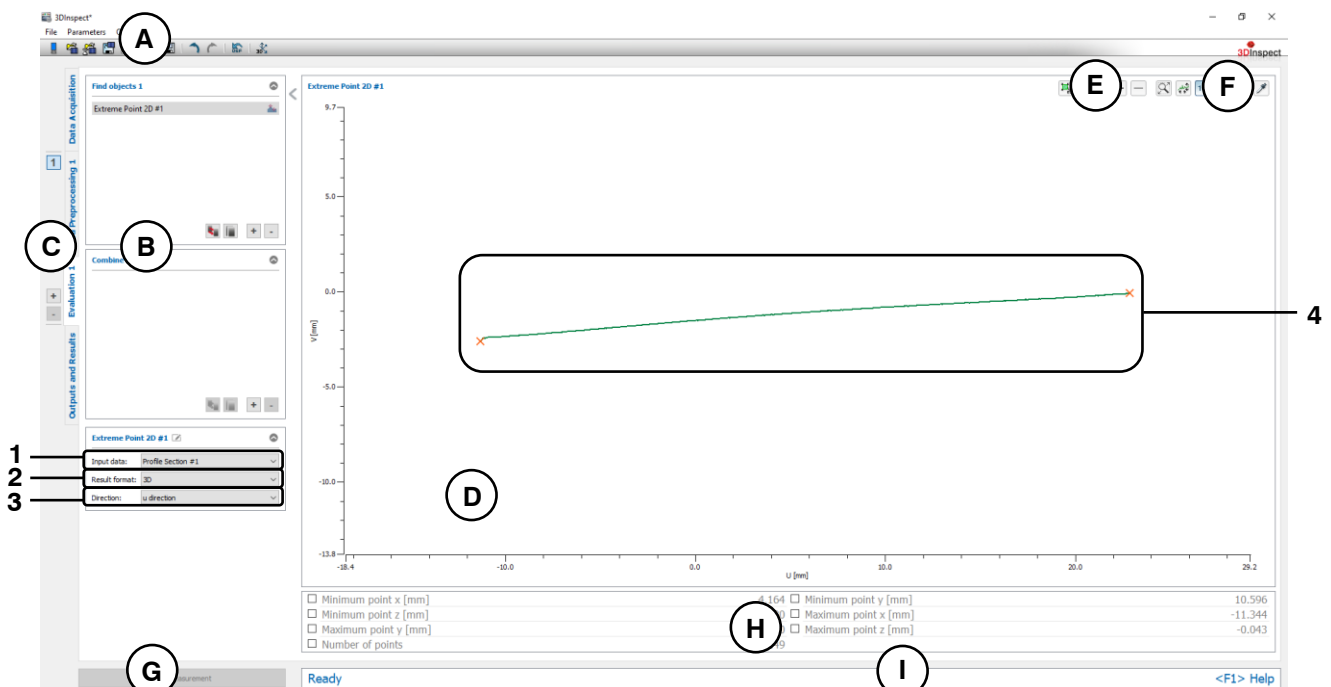

Fig. 6.18: "Extreme Point 2D" Measuring Program

Display Elements and Parameters in the "Extreme Point 2D" Program:

- A "General" toolbar:** Using this toolbar, you can select the data source (see Chapter 3.4 and 3.5), save and load parameters (see Chapter 3.20), reset selected parameters to default settings (see Chapter 3.20.3) and undo and restore changes of settings and parameters (see Chapter 3.21).

- B List of active measuring programs:** This section displays the active measuring programs from the "Find objects" and "Combine objects" groups. You can add and remove measuring programs/measuring program groups (see Chapter 3.15 and 3.17), move measuring programs (see Chapter 3.16) and select an active measuring program for parameterizing and displaying the measured values.
 - C Measuring program groups / Tab bar for switching between views:** This tab bar allows you to switch between the four main views (see Chapter 3.2). To the left of the tab bar you find the section for adding, removing and selecting measuring program groups (see Chapter 3.17).
 - D 2D Profile View:** The 2D Profile View visualizes the 2D data (see Chapter 3.13).
 - E "Measuring" toolbar:** Use this toolbar to set various ROIs for the measurement (see Chapter 3.18.5, 3.18.6 and 3.18.7).
 - F "2D Profile View" toolbar:** Use this toolbar to scale the 2D Profile View and activate various options for mouse interaction (see Chapter 3.13).
 - G "Start measurement" button:** Click on this button to perform a measuring operation, calculate the measurement results and display the profile and measurement results of the currently selected measuring program in the 2D Profile View.
 - H Results display:** The measurement results of the currently selected measuring program are displayed. Here, you can select which measured values are to be made available later for calculation, OK/nOK assessment, logging and output (see Chapter 3.18.9).
 - I Status bar:** Status and error messages are displayed in the status bar (see Chapter 8.1).
- 1 Input data:** Use this selection field to select the input data for the program (see also Chapter 3.18.3).
 - 2 Result format:** Choose whether the measured values are to be output in the two or three dimensional space. This affects the results display, the calculating, assessing, logging and output of the measured values.
 - 3 Algorithm:** Select the direction in space for determining the extreme points. The following options are available:
 - **U direction:** Determine the extreme points in the u direction.
 - **V direction:** Determine the extreme points in the v direction.
 - 4 2D Profile View:** The determined extreme points are displayed as orange points in the 2D Profile View. The points that were used to determine the extreme point (green) and the discarded points (gray) are displayed.

6.1.17 "Line Fit 2D" Measuring Program

Use the "Line Fit 2D" program to calculate a line at 2D points.

Note: The "Line Fit 2D" program needs a 2D profile as input data. The "Profile Section" measuring program can be used in order to generate a 2D profile. (see Chapter [5.1.19](#))

Proceed as follows:

- If applicable, select the input data for the program (see below, section "1" and Chapter [3.18.3](#)).
- If necessary, limit the range for the line calculation in order to eliminate interfering points (see section "E" and Chapter [3.18.5](#), [3.18.6](#) and [3.18.7](#)).
- If required, choose a mode for the line fit and if necessary enter a suitable threshold to eliminate outliers (see below, section "2").
- If applicable, select measured values that are to be used later for calculation, OK/nOK assessment, logging and output (see below, section "H" and Chapter [3.18.9](#)).

Depending on the selected parameter "Result format" (see below, section "2") the measuring program outputs the following measured values:

- **Center of gravity x:** The X coordinate of the center of gravity of the points that were used to calculate the line in the three dimensional space.
- **Center of gravity y:** The Y coordinate of the center of gravity of the points that were used to calculate the line in the three dimensional space.
- **Center of gravity z:** The Z coordinate of the center of gravity of the points that were used to calculate the line in the three dimensional space.
- **Angle to x/y plane:** The angle of the calculated line with respect to the X/Y plane in the three dimensional space.
- **Angle to y/z plane:** The angle of the calculated line with respect to the Y/Z plane in the three dimensional space.
- **Angle to z/x plane:** The angle of the calculated line with respect to the Z/X plane in the three dimensional space.
- **Center of gravity u:** The U coordinate of the center of gravity of the points that were used to calculate the line in the two dimensional space.
- **Center of gravity v:** The V coordinate of the center of gravity of the points that were used to calculate the line in the two dimensional space.
- **Angle:** The angle of the calculated line with respect to the x axis in the two dimensional space.
- **Distance to origin:** The distance to origin of the calculated line in the two dimensional space.
- **Number of points:** The number of points in the profile that were used to calculate the line.
- **Sigma:** The standard deviation of the distances between the points that were used to calculate the line and the calculated line.
- **Peak to Valley (PV):** The distance between the highest and lowest point relative to the calculated line. The highest and lowest point is determined from the points that were used to calculate the line.

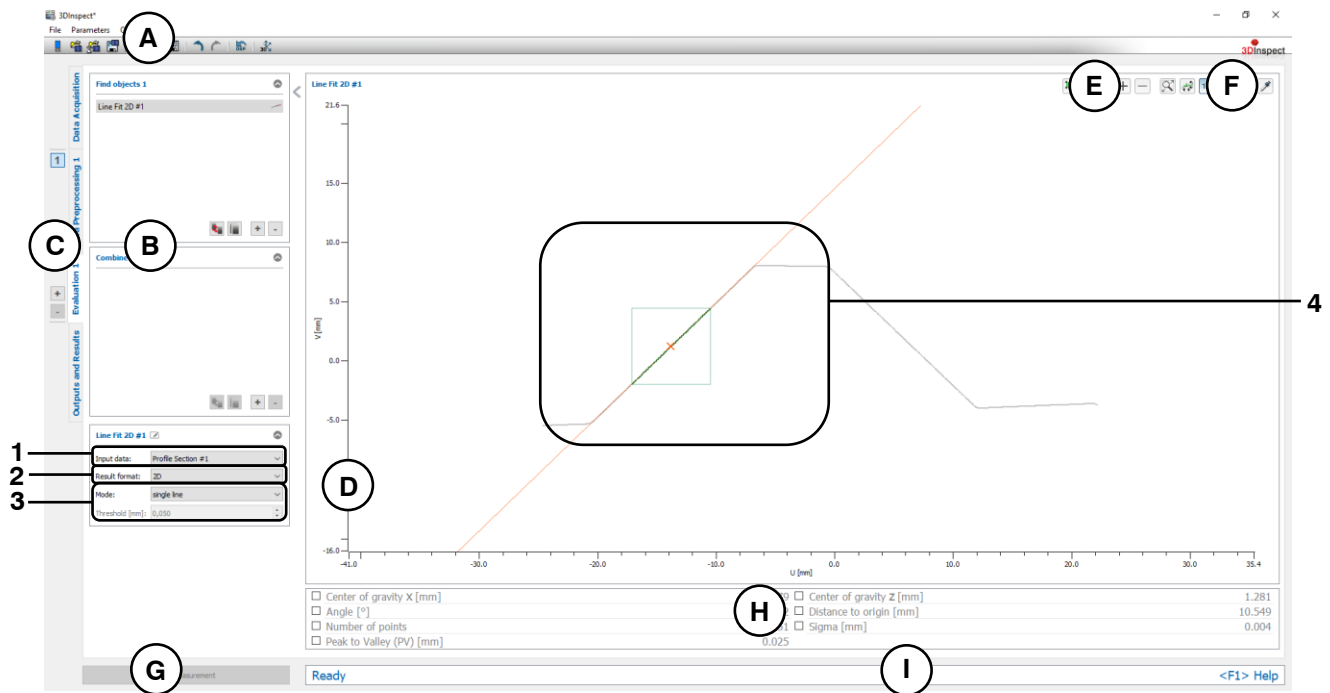

Fig. 6.19: "Line Fit 2D" Measuring Program

Display Elements and Parameters in the "Line Fit 2D" Program:

- A "General" toolbar:** Using this toolbar, you can select the data source (see Chapter 3.4 and 3.5), save and load parameters (see Chapter 3.20), reset selected parameters to default settings (see Chapter 3.20.3) and undo and restore changes of settings and parameters (see Chapter 3.21).
 - B List of active measuring programs:** This section displays the active measuring programs from the "Find objects" and "Combine objects" groups. You can add and remove measuring programs/measuring program groups (see Chapter 3.15 and 3.17), move measuring programs (see Chapter 3.16) and select an active measuring program for parameterizing and displaying the measured values.
 - C Measuring program groups / Tab bar for switching between views:** This tab bar allows you to switch between the four main views (see Chapter 3.2). To the left of the tab bar you find the section for adding, removing and selecting measuring program groups (see Chapter 3.17).
 - D 2D Profile View:** The 2D Profile View visualizes the 2D data (see Chapter 3.13).
 - E "Measuring" toolbar:** Use this toolbar to set various ROIs for the measurement (see Chapter 3.18.5, 3.18.6 and 3.18.7).
 - F "2D Profile View" toolbar:** Use this toolbar to scale the 2D Profile View and activate various options for mouse interaction (see Chapter 3.13).
 - G "Start measurement" button:** Click on this button to perform a measuring operation, calculate the measurement results and display the profile and measurement results of the currently selected measuring program in the 2D Profile View.
 - H Results display:** The measurement results of the currently selected measuring program are displayed. Here, you can select which measured values are to be made available later for calculation, OK/nOK assessment, logging and output (see Chapter 3.18.9).
 - I Status bar:** Status and error messages are displayed in the status bar (see Chapter 8.1).
- 1 Input data:** Use this selection field to select the input data for the program (see also Chapter 3.18.3).
 - 2 Result format:** Choose whether the measured values are to be output in the two or three dimensional space. This affects the results display, the calculating, assessing, logging and output of the measured values.

- 3** - **Mode:** The following modes are available for the line fit:
- **Single line:** Uses all selected points to fit a single line.
 - **Single line (eliminate outliers):** An additional preselection is applied to the selected points to which the straight line is fitted. The preselection depends on the entered threshold value.
The optimized fit is suitable for
 - discarding outlier points/point accumulations during straight line fitting
 - considering only the main geometry in the case of small "secondary geometries" presentThe optimized fit is not suitable to achieve improvements within the basic noise of the data.
 - **Double parallel lines:** Use this mode in order to fit two parallel lines. To do so, you have to specify two regions of interest (see Chapter 3.18.5) for selecting the points for the line fit.
- **Threshold [mm]:** The threshold for the preselection of the points. Points that deviate from the line to a smaller degree than the threshold are used for the line fit. A higher threshold means that more points are used for the line fit. This option is only available in mode "Single Line (eliminate outliers)".
- 4** **2D Profile View:** The 2D Profile View shows the fitted lines (orange) and the center of gravity (orange) of the points that were used for the line fit. The points that were used to calculate the line are shown in green. The discarded points are shown in gray.

6.1.18 "Circle Fit 2D" Measuring Program

Use the "Circle Fit 2D" program to calculate a circle at 2D points.

Note: The "Circle Fit 2D" program needs a 2D profile as input data. The "Profile Section" measuring program can be used in order to generate a 2D profile. (see Chapter 5.1.19)

Proceed as follows:

- If applicable, select the input data for the program (see below, section "1" and Chapter 3.18.3).
- If necessary, limit the range for the circle calculation in order to eliminate interfering points (see below, section "E" and Chapter 3.18.5, 3.18.6 and 3.18.7).
- If required, change the mode to eliminate outliers and enter a suitable threshold for the outlier elimination (see below, section "2").
- If applicable, select measured values that are to be used later for calculation, OK/nOK assessment, logging and output (see below, section "H" and Chapter 3.18.9).

Depending on the selected parameter "Result format" (see below, section "2") the measuring program outputs the following measured values:

- **Center x:** The X coordinate of the center point of the calculated circle in the three dimensional space.
- **Center y:** The Y coordinate of the center point of the calculated circle in the three dimensional space.
- **Center z:** The Z coordinate of the center point of the calculated circle in the three dimensional space.
- **Center u:** The U coordinate of the center point of the calculated circle in the two dimensional space.
- **Center v:** The V coordinate of the center point of the calculated circle in the two dimensional space.
- **Radius:** The radius of the calculated circle.
- **Number of points:** The number of points in the 2D profile that were used to calculate the circle.
- **Sigma:** The standard deviation of the distances between the points that were used to calculate the circle and the surface of the calculated circle.
- **Peak to Valley (PV):** The distance between the two points that are furthest away inwards and outwards from the circle, relative to the computed circle. The two points are determined from the points that were used to calculate the circle.

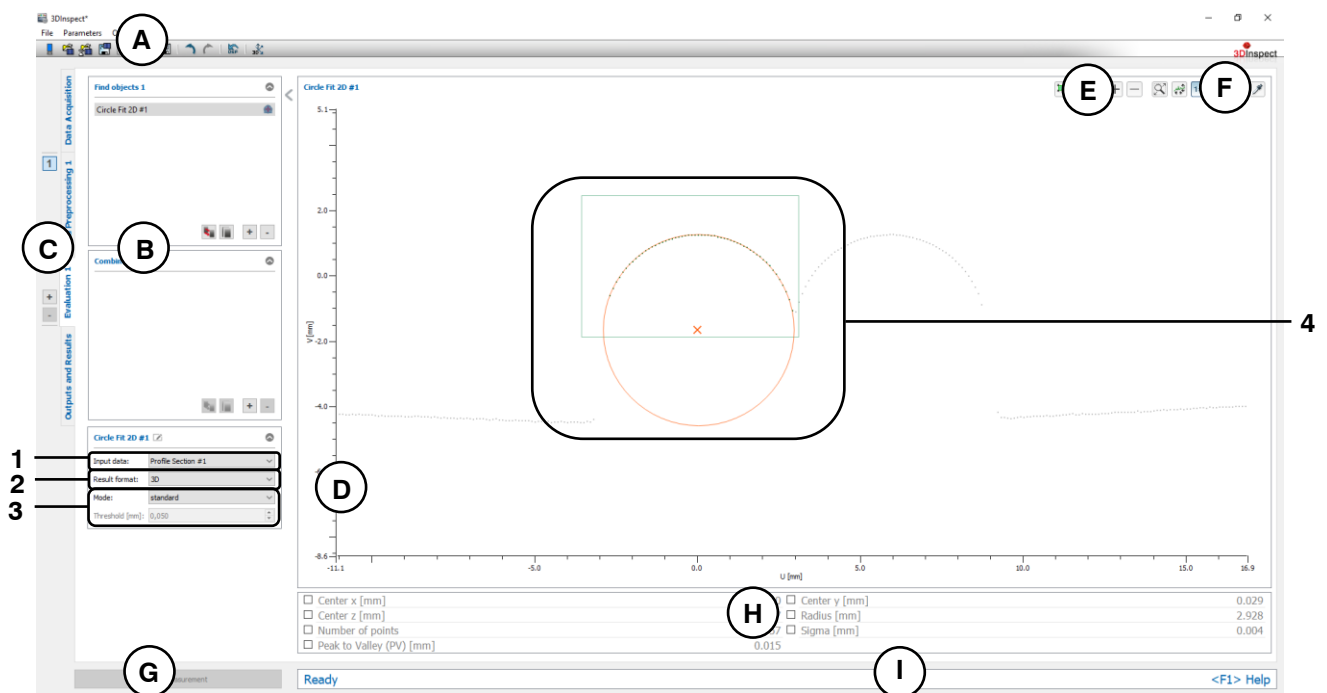

Fig. 6.20: "Circle Fit 2D" Measuring Program

Display Elements and Parameters in the "Circle Fit 2D" Program:

- A "General" toolbar:** Using this toolbar, you can select the data source (see Chapter 3.4 and 3.5), save and load parameters (see Chapter 3.20), reset selected parameters to default settings (see Chapter 3.20.3) and undo and restore changes of settings and parameters (see Chapter 3.21).
- B List of active measuring programs:** This section displays the active measuring programs from the "Find objects" and "Combine objects" groups. You can add and remove measuring programs/measuring program groups (see Chapter 3.15 and 3.17), move measuring programs (see Chapter 3.16) and select an active measuring program for parameterizing and displaying the measured values.
- C Measuring program groups / Tab bar for switching between views:** This tab bar allows you to switch between the four main views (see Chapter 3.2). To the left of the tab bar you find the section for adding, removing and selecting measuring program groups (see Chapter 3.17).
- D 2D Profile View:** The 2D Profile View visualizes the 2D data (see Chapter 3.13).
- E "Measuring" toolbar:** Use this toolbar to set various ROIs for the measurement (see Chapter 3.18.5, 3.18.6 and 3.18.7).
- F "2D Profile View" toolbar:** Use this toolbar to scale the 2D Profile View and activate various options for mouse interaction (see Chapter 3.13).
- G "Start measurement" button:** Click on this button to perform a measuring operation, calculate the measurement results and display the profile and measurement results of the currently selected measuring program in the 2D Profile View.
- H Results display:** The measurement results of the currently selected measuring program are displayed. Here, you can select which measured values are to be made available later for calculation, OK/nOK assessment, logging and output (see Chapter 3.18.9).
- I Status bar:** Status and error messages are displayed in the status bar (see Chapter 8.1).
- 1 Input data:** Use this selection field to select the input data for the program (see also Chapter 3.18.3).
- 2 Result format:** Choose whether the measured values are to be output in the two or three dimensional space. This affects the results display, the calculating, assessing, logging and output of the measured values.
- 3 - Mode:** The following modes are available for circle fit:
- **Standard:** All points which are inside the selection ranges are used for computing the circle fit.
 - **Eliminate outliers:** When this option is selected, an additional preselection of the points is applied prior to the circle fit in order to automatically discard outliers or points that do not belong to the circle. The points are selected such that the distances from the resulting circle are less than the predefined threshold and such that the maximum possible number of points is used. Therefore, only the points that best match the circle are used for the circle fit.
The optimized fit is suitable for
 - discarding outlier points/point accumulations during straight line fitting
 - considering only the main geometry in the case of small "secondary geometries" present
 The optimized fit is not suitable to achieve improvements within the basic noise of the data.
- **Threshold [mm]:** The threshold for the preselection of the points. Points that deviate from the circle to a smaller degree than the threshold are used for the circle fit. A higher threshold means that more points are used for the circle fit.
- 4 2D Profile View:** The 2D Profile View shows the fitted circle (orange). The points that were used to calculate the circle are shown in green. The discarded points are shown in gray.

6.1.19 "Corner Radius 2D" Measuring Program

Use the "Corner Radius 2D" program to calculate the radius of a corner. A circle is fitted to the points of the corner. The circle is additionally defined by two selectable tangents.

Note: The "Corner Radius 2D" program needs a 2D profile as input data. The "Profile Section" measuring program can be used in order to generate a 2D profile. (see Chapter [5.1.19](#))

Proceed as follows:

- If applicable, select the input data for the program (see below, section "1" and Chapter [3.18.3](#)).
- If necessary, limit the range for the corner radius measuring in order to eliminate interfering points (see below, section "E" and Chapter [3.18.5](#), [3.18.6](#) and [3.18.7](#)).
- Enter the range of the opening angle starting from the intersection of the tangents. All points that are within the angle and in the selection range are used for circle fitting (see below, section "3").
- If applicable, select measured values that are to be used later for calculation, OK/nOK assessment, logging and output (see below, section "H" and Chapter [3.18.9](#)).

Depending on the selected parameter "Result format" (see below, section "2") the measuring program outputs the following measured values:

- **Center x:** The X coordinate of the center point of the calculated circle to the corner in the three dimensional space.
- **Center y:** The Y coordinate of the center point of the calculated circle to the corner in the three dimensional space.
- **Center z:** The Z coordinate of the center point of the calculated circle to the corner in the three dimensional space.
- **Center u:** The U coordinate of the center point of the calculated circle to the corner in the two dimensional space.
- **Center v:** The V coordinate of the center point of the calculated circle to the corner in the two dimensional space.
- **Radius:** The radius of the calculated circle to the corner.
- **Number of points:** The number of points in the 2D profile that were used to calculate the circle to the corner.
- **Sigma:** The standard deviation of the distances between the points that were used to calculate the circle to the corner and the surface of the calculated circle to the corner.
- **Peak to Valley (PV):** The distance between the two points that are furthest away inwards and outwards from the circle, relative to the computed circle to the corner. The two points are determined from the points that were used to calculate the circle to the corner.

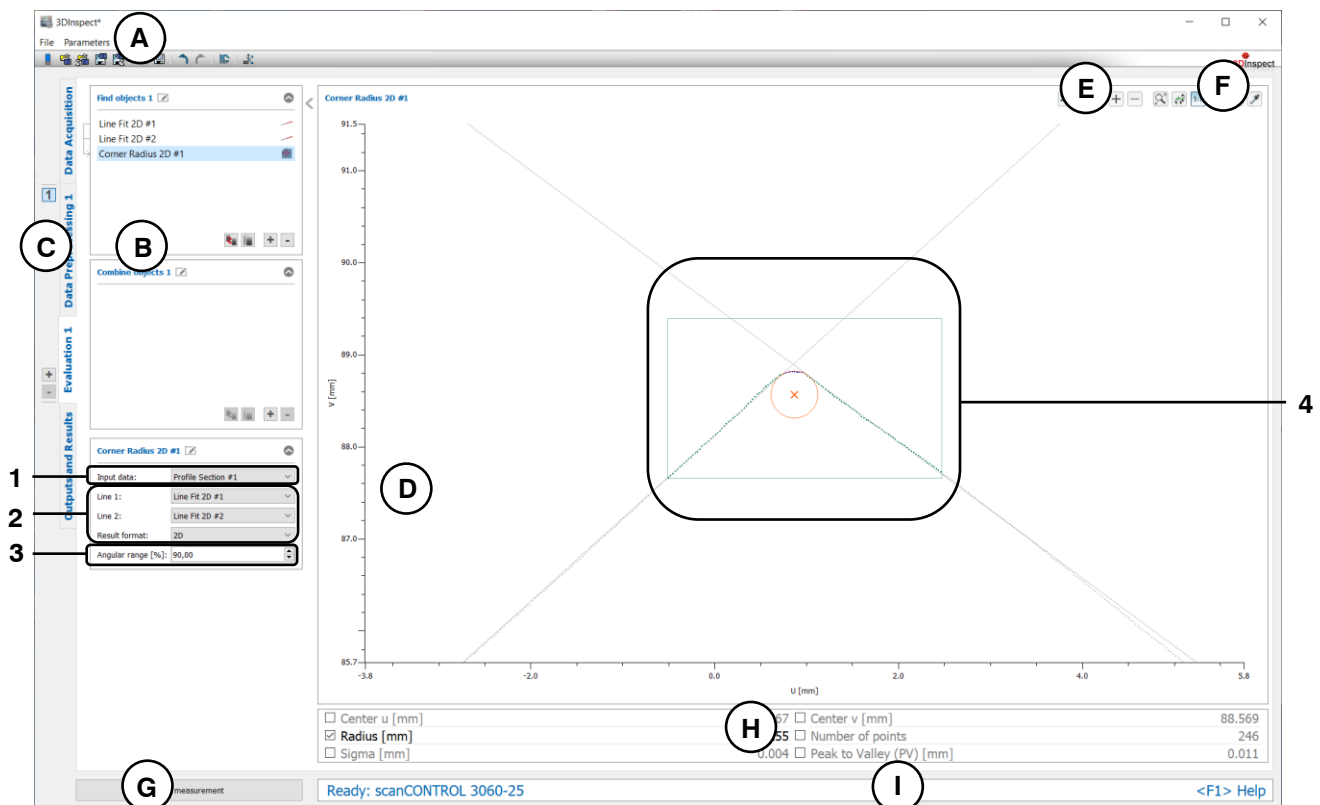

Fig. 6.21: "Corner Radius 2D" Measuring Program

Display Elements and Parameters in the "Corner Radius 2D" Program:

- A** **"General" toolbar:** Using this toolbar, you can select the data source (see Chapter 3.4 and 3.5), save and load parameters (see Chapter 3.20), reset selected parameters to default settings (see Chapter 3.20.3) and undo and restore changes of settings and parameters (see Chapter 3.21).
- B** **List of active measuring programs:** This section displays the active measuring programs from the "Find objects" and "Combine objects" groups. You can add and remove measuring programs/measuring program groups (see Chapter 3.15 and 3.17), move measuring programs (see Chapter 3.16) and select an active measuring program for parameterizing and displaying the measured values.
- C** **Measuring program groups / Tab bar for switching between views:** This tab bar allows you to switch between the four main views (see Chapter 3.2). To the left of the tab bar you find the section for adding, removing and selecting measuring program groups (see Chapter 3.17).
- D** **2D Profile View:** The 2D Profile View visualizes the 2D data (see Chapter 3.13).
- E** **"Measuring" toolbar:** Use this toolbar to set various ROIs for the measurement (see Chapter 3.18.5, 3.18.6 and 3.18.7).
- F** **"2D Profile View" toolbar:** Use this toolbar to scale the 2D Profile View and activate various options for mouse interaction (see Chapter 3.13).
- G** **"Start measurement" button:** Click on this button to perform a measuring operation, calculate the measurement results and display the profile and measurement results of the currently selected measuring program in the 2D Profile View.
- H** **Results display:** The measurement results of the currently selected measuring program are displayed. Here, you can select which measured values are to be made available later for calculation, OK/nOK assessment, logging and output (see Chapter 3.18.9).
- I** **Status bar:** Status and error messages are displayed in the status bar (see Chapter 8.1).

- 1 **Input data:** Use this selection field to select the input data and the tangents for the program (see also Chapter 3.18.3). An overview of measuring programs which provide 2D lines can be found in Chapter 3.19.2.
- 2 **Result format:** Choose whether the measured values are to be output in the two or three dimensional space. This affects the results display, the calculating, assessing, logging and output of the measured values.
- 3 **Angular range [%]:** Enter the range of the opening angle starting from the intersection of the tangents. All points that are within the angle and in the selection range are used for circle fitting.
- 4 **2D Profile View:** The 2D profile view shows the fitted circle and the center point (orange). The selected 2D lines that serve as edges of the corner are shown in gray. The points potentially eligible for the calculation of the circle are drawn in green and those used for the calculation of the circle are drawn in blue. The discarded points are shown in gray.

6.1.20 "Roundness 2D" Measuring Program

Use the "Roundness 2D" program to determine the roundness in a 2D profile. Two concentric circles, the inner and the outer minimum zone reference circles, are calculated. The roundness results from the difference of the radii of the two circles.

Note: The "Roundness 2D" program needs a 2D profile as input data. The "Profile Section" measuring program can be used in order to generate a 2D profile. (see Chapter 5.1.19)

Proceed as follows:

- If applicable, select the input data for the program (see below, section "1" and Chapter 3.18.3).
- If necessary, limit the range for the roundness calculation in order to eliminate interfering points (see section "E" and Chapter 3.18.5, 3.18.6 and 3.18.7).
- If applicable, select measured values that are to be used later for calculation, OK/nOK assessment, logging and output (see below, section "H" and Chapter 3.18.9).

The measuring program outputs the following measured values:

- **Roundness:** The difference of the radii of the inner and the outer circles.
- **Center x:** The X coordinate of the center point of the calculated circle in the three dimensional space.
- **Center y:** The Y coordinate of the center point of the calculated circle in the three dimensional space.
- **Center z:** The Z coordinate of the center point of the calculated circle in the three dimensional space.
- **Center u:** The U coordinate of the center point of the calculated circle in the two dimensional space.
- **Center v:** The V coordinate of the center point of the calculated circle in the two dimensional space.
- **Inner reference circle radius:** The radius of the calculated inner minimum zone reference circle.
- **Outer reference circle radius:** The radius of the calculated outer minimum zone reference circle.
- **Number of points:** The number of points in the 2D profile that were used to calculate the circles.

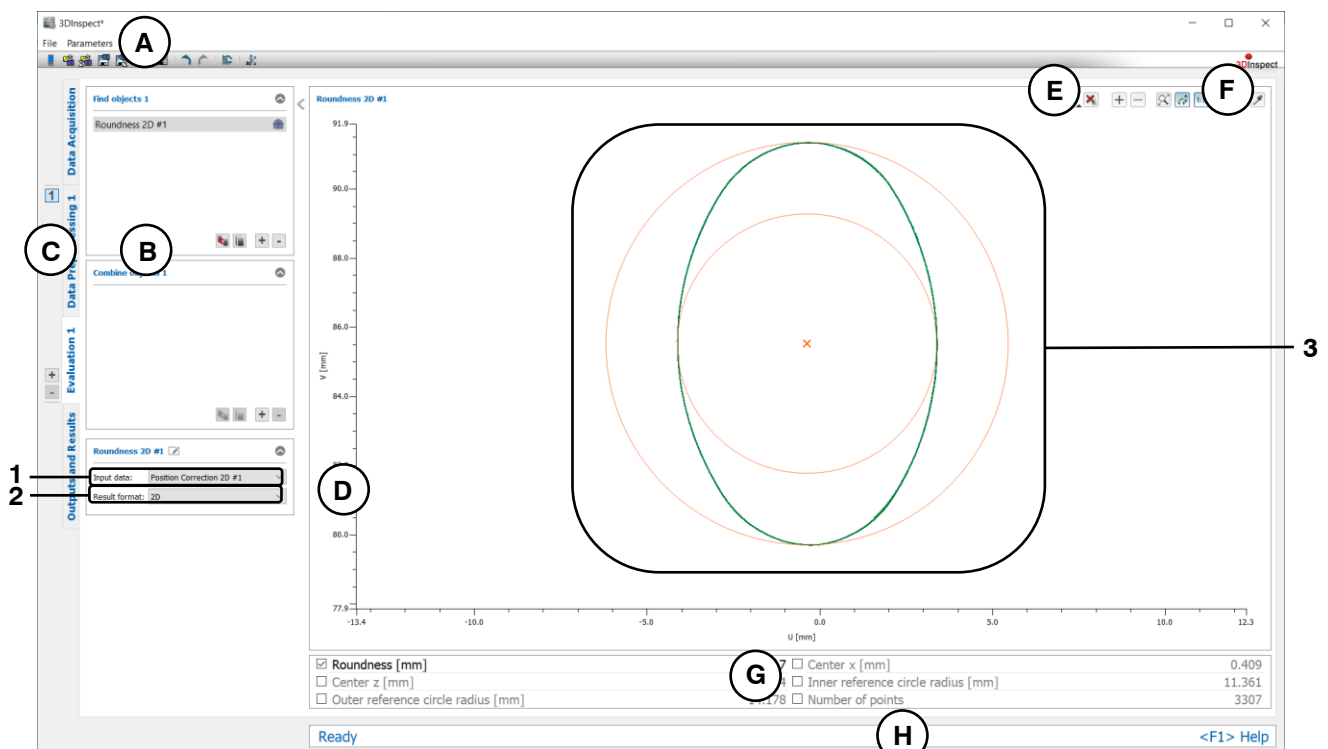

Fig. 6.22: "Roundness 2D" Measuring Program

Display Elements and Parameters in the "Roundness 2D" Program:

- A "General" toolbar:** Using this toolbar, you can select the data source (see Chapter 3.4 and 3.5), save and load parameters (see Chapter 3.20), reset selected parameters to default settings (see Chapter 3.20.3) and undo and restore changes of settings and parameters (see Chapter 3.21).
 - B List of active measuring programs:** This section displays the active measuring programs from the "Find objects" and "Combine objects" groups. You can add and remove measuring programs/measuring program groups (see Chapter 3.15 and 3.17), move measuring programs (see Chapter 3.16) and select an active measuring program for parameterizing and displaying the measured values.
 - C Measuring program groups / Tab bar for switching between views:** This tab bar allows you to switch between the four main views (see Chapter 3.2). To the left of the tab bar you find the section for adding, removing and selecting measuring program groups (see Chapter 3.17).
 - D 2D Profile View:** The 2D Profile View visualizes the 2D data (see Chapter 3.13).
 - E "Measuring" toolbar:** Use this toolbar to set various ROIs for the measurement (see Chapter 3.18.5, 3.18.6 and 3.18.7).
 - F "2D Profile View" toolbar:** Use this toolbar to scale the 2D Profile View and activate various options for mouse interaction (see Chapter 3.13).
 - G Results display:** The measurement results of the currently selected measuring program are displayed. Here, you can select which measured values are to be made available later for calculation, OK/nOK assessment, logging and output (see Chapter 3.18.9).
 - H Status bar:** Status and error messages are displayed in the status bar (see Chapter 8.1).
-
- 1 Input data:** Use this selection field to select the input data for the program (see also Chapter 3.18.3).
 - 2 Result format:** Choose whether the measured values are to be output in the two or three dimensional space. This affects the results display, the calculating, assessing, logging and output of the measured values.
 - 3 2D Profile View:** In the 2D profile view, the inner and the outer minimum zone reference circles are drawn in orange. The points that were used to determine the roundness are drawn in green. The discarded points are displayed in gray.

6.1.21 "Seam 2D" Measuring Program

Use the "Seam 2D" program to measure a seam in a 2D profile. All points that lie above a threshold line are used to detect the seam.

Note: The "Seam 2D" program needs a 2D profile as input data. The "Profile Section" measuring program can be used in order to generate a 2D profile. (see Chapter 5.1.19)

Note: In addition to the input profile, the "Seam 2D" measuring program requires a 2D line as input data. This line has to be computed with the "Line Fit 2D" measuring program (see Chapter 6.1.17).

Proceed as follows:

- First, if you have not already, insert the "Line Fit 2D" measuring program and configure the measuring program in order to obtain a reference line (see Chapter 6.1.17). Move the measuring program such that it comes before the "Seam 2D" program in the list of active measuring programs (see Chapter 3.16).
- Select the input data and the reference line for the program (see below, section "1" and Chapter 3.18.3).
- If necessary, limit the range for measuring the seam in order to eliminate interfering points (see section "E" and Chapter 3.18.5, 3.18.6 and 3.18.7).
- Set the threshold value relative to the reference line (section "E"). If 2D points exist above the threshold, a seam is detected.
- Define the minimum width (euclidean) for the seam and the search direction (see Fig. 6.23) for determining the seam (see below, area "3").
- If applicable, select measured values that are to be used later for calculation, OK/nOK assessment, logging and output (see below, section "H" and Chapter 3.18.9).

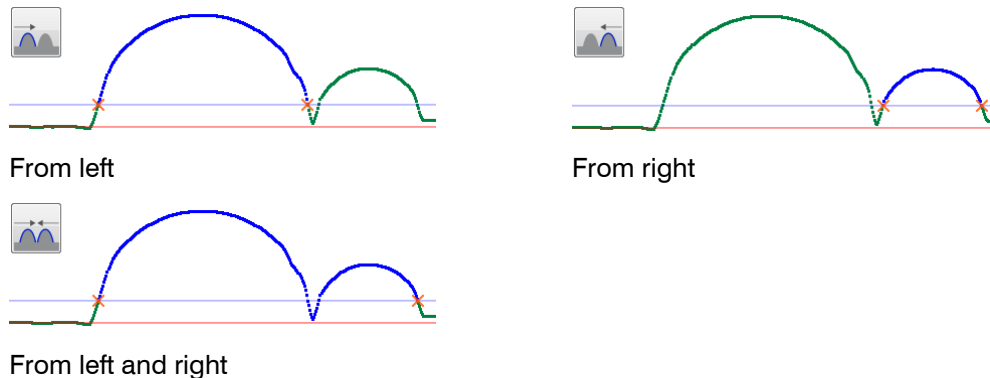

Fig. 6.23: Search direction

The measuring program outputs the following measured values:

- **Width:** The euclidean distance between the left and right points of the measured seam.
- **Height:** The height of the measured seam related to reference line.
- **Left point x:** The X coordinate of the left point of the measured seam in the three dimensional space.
- **Left point y:** The Y coordinate of the left point of the measured seam in the three dimensional space.
- **Left point z:** The Z coordinate of the left point of the measured seam in the three dimensional space.
- **Maximum point x:** The X coordinate of the maximum point of the measured seam in the three dimensional space.
- **Maximum point y:** The Y coordinate of the maximum point of the measured seam in the three dimensional space.
- **Maximum point z:** The Z coordinate of the maximum point of the measured seam in the three dimensional space.
- **Right point x:** The X coordinate of the right point of the measured seam in the three dimensional space.

- **Right point y:** The Y coordinate of the right point of the measured seam in the three dimensional space.
- **Right point z:** The Z coordinate of the right point of the measured seam in the three dimensional space.
- **Left point u:** The U coordinate of the left point of the measured seam in the two dimensional space.
- **Left point v:** The V coordinate of the left point of the measured seam in the two dimensional space.
- **Maximum point u:** The U coordinate of the maximum point of the measured seam in the two dimensional space.
- **Maximum point v:** The V coordinate of the maximum point of the measured seam in the two dimensional space.
- **Right point u:** The U coordinate of the right point of the measured seam in the two dimensional space.
- **Right point v:** The V coordinate of the right point of the measured seam in the two dimensional space.
- **Area:** The area of the measured seam related to reference line.
- **Number of points:** The number of points in the 2D profile which have been used for measuring the seam.

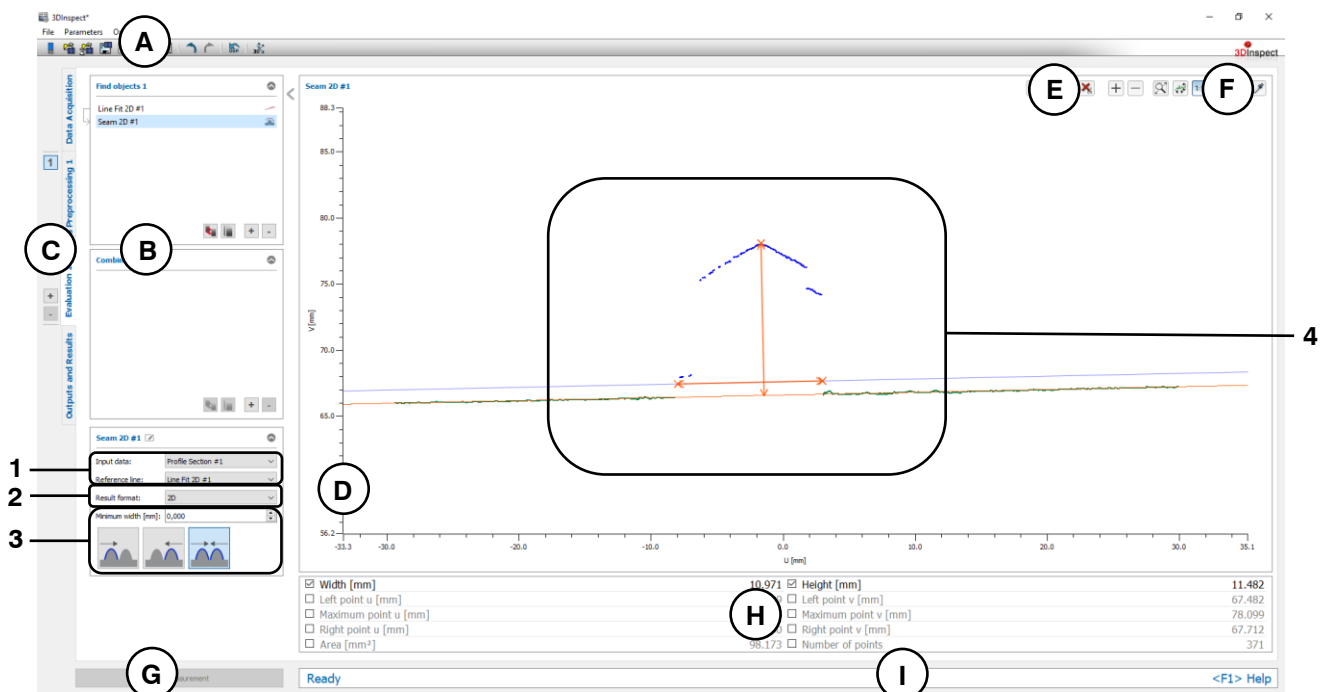

Fig. 6.24: "Seam 2D" Measuring Program

Display Elements and Parameters in the "Seam 2D" Program:

- A "General" toolbar:** Using this toolbar, you can select the data source (see Chapter 3.4 and 3.5), save and load parameters (see Chapter 3.20), reset selected parameters to default settings (see Chapter 3.20.3) and undo and restore changes of settings and parameters (see Chapter 3.21).
- B List of active measuring programs:** This section displays the active measuring programs from the "Find objects" and "Combine objects" groups. You can add and remove measuring programs/measuring program groups (see Chapter 3.15 and 3.17), move measuring programs (see Chapter 3.16) and select an active measuring program for parameterizing and displaying the measured values.
- C Measuring program groups / Tab bar for switching between views:** This tab bar allows you to switch between the four main views (see Chapter 3.2). To the left of the tab bar you find the section for adding, removing and selecting measuring program groups (see Chapter 3.17).
- D 2D Profile View:** The 2D Profile View visualizes the 2D data (see Chapter 3.13).

- E** **"Measuring" toolbar:** Use this toolbar to set various ROIs for the measurement (see Chapter 3.18.5, 3.18.6 and 3.18.7).
 - F** **"2D Profile View" toolbar:** Use this toolbar to scale the 2D Profile View and activate various options for mouse interaction (see Chapter 3.13).
 - G** **"Start measurement" button:** Click on this button to perform a measuring operation, calculate the measurement results and display the profile and measurement results of the currently selected measuring program in the 2D Profile View.
 - H** **Results display:** The measurement results of the currently selected measuring program are displayed. Here, you can select which measured values are to be made available later for calculation, OK/nOK assessment, logging and output (see Chapter 3.18.9).
 - I** **Status bar:** Status and error messages are displayed in the status bar (see Chapter 8.1).
-
- 1** **Input data:** Use this selection field to select the input data and the reference line for the program (see also Chapter 3.18.3). An overview of measuring programs which provide 2D lines can be found in Chapter 3.19.2.
 - 2** **Result format:** Choose whether the measured values are to be output in the two or three dimensional space. This affects the results display, the calculating, assessing, logging and output of the measured values.
 - 3**
 - **Minimum width:** Define the minimum width (euclidean) for the seam.
 - **Search direction:** Define the search direction for detecting the seam (see Fig. 6.23):
 - From left: The seam is searched from the left.
 - From right: The seam is searched from the left.
 - From left and right: The seam is searched from the left and right.
 - 4** **2D Profile View:** In the 2D profile view, the left, right and highest points of the seam as well as the height and width are drawn in orange. The points associated with the seam are displayed in blue. The reference and threshold lines are displayed in orange and blue, respectively. The points that were used to determine the seam are drawn in green. The discarded points are displayed in gray.

6.1.22 "Groove 2D" Measuring Program

Use the "Groove 2D" program to measure a groove in a 2D profile. All points that lie below a threshold line are used to detect the groove.

Note: The "Groove 2D" program needs a 2D profile as input data. The "Profile Section" measuring program can be used in order to generate a 2D profile. (see Chapter 5.1.19)

Note: In addition to the input profile, the "Groove 2D" measuring program requires a 2D line as input data. This line has to be computed with the "Line Fit 2D" measuring program (see Chapter 6.1.17).

Proceed as follows:

- First, if you have not already, insert the "Line Fit 2D" measuring program and configure the measuring program in order to obtain a reference line (see Chapter 6.1.17). Move the measuring program such that it comes before the "Groove 2D" program in the list of active measuring programs (see Chapter 3.16).
- Select the input data and the reference line for the program (see below, section "1" and Chapter 3.18.3).
- If necessary, limit the range for measuring the groove in order to eliminate interfering points (see section "E" and Chapter 3.18.5, 3.18.6 and 3.18.7).
- Set the threshold value relative to the reference line (section "E"). If 2D points exist below the threshold, a groove is detected.
- Define the minimum width (euclidean) for the groove and the search direction (see Fig. 6.23) for determining the groove (see below, area "3").
- If applicable, select measured values that are to be used later for calculation, OK/nOK assessment, logging and output (see below, section "H" and Chapter 3.18.9).

The measuring program outputs the following measured values:

- **Width:** The euclidean distance between the left and right points of the measured groove.
- **Depth:** The depth of the measured groove related to reference line.
- **Left point x:** The X coordinate of the left point of the measured groove in the three dimensional space.
- **Left point y:** The Y coordinate of the left point of the measured groove in the three dimensional space.
- **Left point z:** The Z coordinate of the left point of the measured groove in the three dimensional space.
- **Minimum point x:** The X coordinate of the maximum point of the measured groove in the three dimensional space.
- **Minimum point y:** The Y coordinate of the maximum point of the measured groove in the three dimensional space.
- **Minimum point z:** The Z coordinate of the maximum point of the measured groove in the three dimensional space.
- **Right point x:** The X coordinate of the right point of the measured groove in the three dimensional space.
- **Right point y:** The Y coordinate of the right point of the measured groove in the three dimensional space.
- **Right point z:** The Z coordinate of the right point of the measured groove in the three dimensional space.
- **Left point u:** The U coordinate of the left point of the measured groove in the two dimensional space.
- **Left point v:** The V coordinate of the left point of the measured groove in the two dimensional space.
- **Minimum point u:** The U coordinate of the minimum point of the measured groove in the two dimensional space.
- **Minimum point v:** The V coordinate of the minimum point of the measured groove in the two dimensional space.
- **Right point u:** The U coordinate of the right point of the measured groove in the two dimensional space.

- **Right point v:** The V coordinate of the right point of the measured groove in the two dimensional space.
- **Area:** The area of the measured groove related to reference line.
- **Number of points:** The number of points in the 2D profile which have been used for measuring the groove.

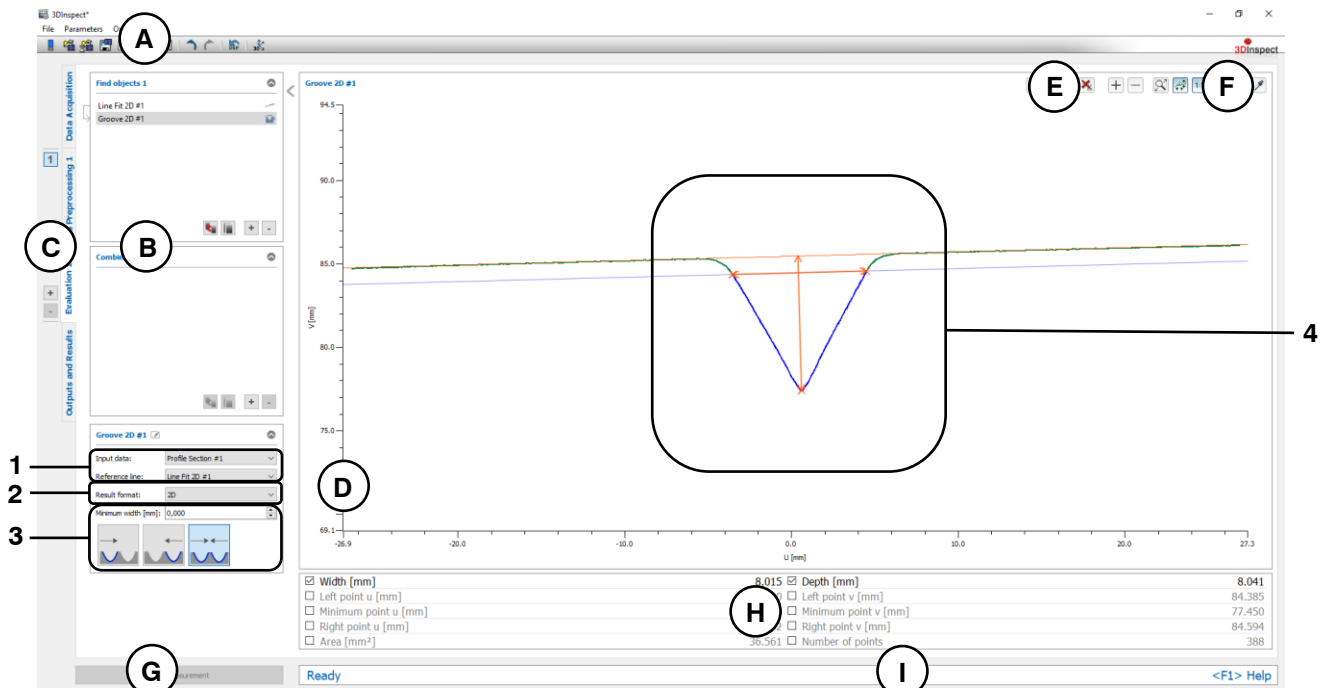

Fig. 6.25: "Groove 2D" Measuring Program

Display Elements and Parameters in the "Groove 2D" Program:

- A "General" toolbar:** Using this toolbar, you can select the data source (see Chapter 3.4 and 3.5), save and load parameters (see Chapter 3.20), reset selected parameters to default settings (see Chapter 3.20.3) and undo and restore changes of settings and parameters (see Chapter 3.21).
- B List of active measuring programs:** This section displays the active measuring programs from the "Find objects" and "Combine objects" groups. You can add and remove measuring programs/measuring program groups (see Chapter 3.15 and 3.17), move measuring programs (see Chapter 3.16) and select an active measuring program for parameterizing and displaying the measured values.
- C Measuring program groups / Tab bar for switching between views:** This tab bar allows you to switch between the four main views (see Chapter 3.2). To the left of the tab bar you find the section for adding, removing and selecting measuring program groups (see Chapter 3.17).
- D 2D Profile View:** The 2D Profile View visualizes the 2D data (see Chapter 3.13).
- E "Measuring" toolbar:** Use this toolbar to set various ROIs for the measurement (see Chapter 3.18.5, 3.18.6 and 3.18.7).
- F "2D Profile View" toolbar:** Use this toolbar to scale the 2D Profile View and activate various options for mouse interaction (see Chapter 3.13).
- G "Start measurement" button:** Click on this button to perform a measuring operation, calculate the measurement results and display the profile and measurement results of the currently selected measuring program in the 2D Profile View.
- H Results display:** The measurement results of the currently selected measuring program are displayed. Here, you can select which measured values are to be made available later for calculation, OK/nOK assessment, logging and output (see Chapter 3.18.9).
- I Status bar:** Status and error messages are displayed in the status bar (see Chapter 8.1).

- 1 **Input data:** Use this selection field to select the input data and the reference line for the program (see also Chapter 3.18.3). An overview of measuring programs which provide 2D lines can be found in Chapter 3.19.2.
- 2 **Result format:** Choose whether the measured values are to be output in the two or three dimensional space. This affects the results display, the calculating, assessing, logging and output of the measured values.
- 3
 - **Minimum width:** Define the minimum width (euclidean) for the groove.
 - **Search direction:** Define the search direction for detecting the groove (see Fig. 6.23):
 - From left: The groove is searched from the left.
 - From right: The groove is searched from the left.
 - From left and right: The groove is searched from the left and right.
- 4 **2D Profile View:** In the 2D profile view, the left, right and highest points of the groove as well as the height and width are drawn in orange. The points associated with the groove are displayed in blue. The reference and threshold lines are displayed in orange and blue, respectively. The points that were used to determine the groove are drawn in green. The discarded points are displayed in gray.

6.1.23 "Circle Seam 2D" Measuring Program

Use the "Circle Seam 2D" program to measure a seam in a 2D profile on a circular profile section. All points that lie outside a threshold circle are used to detect the seam.

Note: The "Circle Seam 2D" program needs a 2D profile as input data. The "Profile Section" measuring program can be used in order to generate a 2D profile. (see Chapter 5.1.19)

Note: In addition to the input profile, the "Circle Seam 2D" measuring program requires a 2D circle as input data. This circle has to be computed with the "Circle Fit 2D" measuring program (see Chapter 6.1.18).

Proceed as follows:

- First, if you have not already, insert the "Circle Fit 2D" measuring program and configure the measuring program in order to obtain a reference circle (see Chapter 6.1.18). Move the measuring program such that it comes before the "Circle Seam 2D" program in the list of active measuring programs (see Chapter 3.16).
- Select the input data and the reference line for the program (see below, section "1" and Chapter 3.18.3).
- If necessary, limit the range for measuring the seam in order to eliminate interfering points (see section "E" and Chapter 3.18.5, 3.18.6 and 3.18.7).
- Set the threshold value relative to the reference circle (section "E"). If 2D points exist outside the threshold, a seam is detected.
- Define the minimum width (euclidean) for the seam and the search direction (see Fig. 6.23) for determining the seam (see below, area "3").
- If applicable, select measured values that are to be used later for calculation, OK/nOK assessment, logging and output (see below, section "H" and Chapter 3.18.9).

The measuring program outputs the following measured values:

- **Width:** The euclidean distance between the left and right points of the measured seam.
- **Height:** The height of the measured seam related to reference line.
- **Left point x:** The X coordinate of the left point of the measured seam in the three dimensional space.
- **Left point y:** The Y coordinate of the left point of the measured seam in the three dimensional space.
- **Left point z:** The Z coordinate of the left point of the measured seam in the three dimensional space.
- **Maximum point x:** The X coordinate of the maximum point of the measured seam in the three dimensional space.
- **Maximum point y:** The Y coordinate of the maximum point of the measured seam in the three dimensional space.
- **Maximum point z:** The Z coordinate of the maximum point of the measured seam in the three dimensional space.
- **Right point x:** The X coordinate of the right point of the measured seam in the three dimensional space.
- **Right point y:** The Y coordinate of the right point of the measured seam in the three dimensional space.
- **Right point z:** The Z coordinate of the right point of the measured seam in the three dimensional space.
- **Left point u:** The U coordinate of the left point of the measured seam in the two dimensional space.
- **Left point v:** The V coordinate of the left point of the measured seam in the two dimensional space.
- **Maximum point u:** The U coordinate of the maximum point of the measured seam in the two dimensional space.
- **Maximum point v:** The V coordinate of the maximum point of the measured seam in the two dimensional space.
- **Right point u:** The U coordinate of the right point of the measured seam in the two dimensional space.

- **Right point v:** The V coordinate of the right point of the measured seam in the two dimensional space.
- **Area:** The area of the measured seam related to reference circle.
- **Number of points:** The number of points in the 2D profile which have been used for measuring the seam.

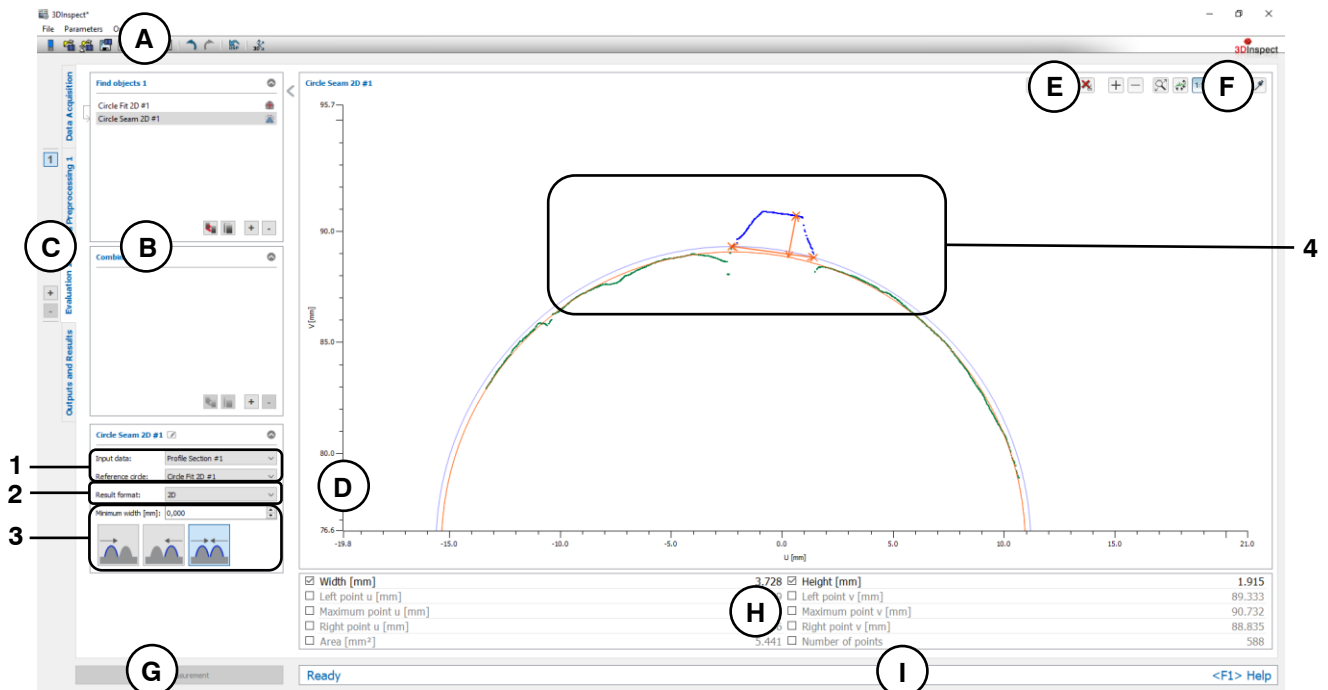

Fig. 6.26: "Circle Seam 2D" Measuring Program

Display Elements and Parameters in the "Circle Seam 2D" Program:

- A "General" toolbar:** Using this toolbar, you can select the data source (see Chapter 3.4 and 3.5), save and load parameters (see Chapter 3.20), reset selected parameters to default settings (see Chapter 3.20.3) and undo and restore changes of settings and parameters (see Chapter 3.21).
- B List of active measuring programs:** This section displays the active measuring programs from the "Find objects" and "Combine objects" groups. You can add and remove measuring programs/measuring program groups (see Chapter 3.15 and 3.17), move measuring programs (see Chapter 3.16) and select an active measuring program for parameterizing and displaying the measured values.
- C Measuring program groups / Tab bar for switching between views:** This tab bar allows you to switch between the four main views (see Chapter 3.2). To the left of the tab bar you find the section for adding, removing and selecting measuring program groups (see Chapter 3.17).
- D 2D Profile View:** The 2D Profile View visualizes the 2D data (see Chapter 3.13).
- E "Measuring" toolbar:** Use this toolbar to set various ROIs for the measurement (see Chapter 3.18.5, 3.18.6 and 3.18.7).
- F "2D Profile View" toolbar:** Use this toolbar to scale the 2D Profile View and activate various options for mouse interaction (see Chapter 3.13).
- G "Start measurement" button:** Click on this button to perform a measuring operation, calculate the measurement results and display the profile and measurement results of the currently selected measuring program in the 2D Profile View.
- H Results display:** The measurement results of the currently selected measuring program are displayed. Here, you can select which measured values are to be made available later for calculation, OK/nOK assessment, logging and output (see Chapter 3.18.9).
- I Status bar:** Status and error messages are displayed in the status bar (see Chapter 8.1).

- 1 **Input data:** Use this selection field to select the input data and the reference circle for the program (see also Chapter 3.18.3). An overview of measuring programs which provide 2D circles can be found in Chapter 3.19.4.
- 2 **Result format:** Choose whether the measured values are to be output in the two or three dimensional space. This affects the results display, the calculating, assessing, logging and output of the measured values.
- 3
 - **Minimum width:** Define the minimum width (euclidean) for the seam.
 - **Search direction:** Define the search direction for detecting the seam (see Fig. 6.23):
 - From left: The seam is searched from the left.
 - From right: The seam is searched from the left.
 - From left and right: The seam is searched from the left and right.
- 4 **2D Profile View:** In the 2D profile view, the left, right and highest points of the seam as well as the height and width are drawn in orange. The points associated with the seam are displayed in blue. The reference and threshold circles are displayed in orange and blue, respectively. The points that were used to determine the seam are drawn in green. The discarded points are displayed in gray.

6.1.24 "Circle Groove 2D" Measuring Program

Use the "Circle Groove 2D" program to measure a groove in a 2D profile on a circular profile section. All points that lie inside a threshold circle are used to detect the groove.

Note: The "Circle Groove 2D" program needs a 2D profile as input data. The "Profile Section" measuring program can be used in order to generate a 2D profile. (see Chapter 5.1.19)

Note: In addition to the input profile, the "Circle Groove 2D" measuring program requires a 2D circle as input data. This circle has to be computed with the "Circle Fit 2D" measuring program (see Chapter 6.1.18).

Proceed as follows:

- First, if you have not already, insert the "Circle Fit 2D" measuring program and configure the measuring program in order to obtain a reference circle (see Chapter 6.1.18). Move the measuring program such that it comes before the "Circle Groove 2D" program in the list of active measuring programs (see Chapter 3.16).
- Select the input data and the reference line for the program (see below, section "1" and Chapter 3.18.3).
- If necessary, limit the range for measuring the groove in order to eliminate interfering points (see section "E" and Chapter 3.18.5, 3.18.6 and 3.18.7).
- Set the threshold value relative to the reference circle (section "E"). If 2D points exist inside the threshold, a groove is detected.
- Define the minimum width (euclidean) for the groove and the search direction (see Fig. 6.23) for determining the groove (see below, area "3").
- If applicable, select measured values that are to be used later for calculation, OK/nOK assessment, logging and output (see below, section "H" and Chapter 3.18.9).

The measuring program outputs the following measured values:

- **Width:** The euclidean distance between the left and right points of the measured groove.
- **Depth:** The depth of the measured groove related to reference line.
- **Left point x:** The X coordinate of the left point of the measured groove in the three dimensional space.
- **Left point y:** The Y coordinate of the left point of the measured groove in the three dimensional space.
- **Left point z:** The Z coordinate of the left point of the measured groove in the three dimensional space.
- **Minimum point x:** The X coordinate of the maximum point of the measured groove in the three dimensional space.
- **Minimum point y:** The Y coordinate of the maximum point of the measured groove in the three dimensional space.
- **Minimum point z:** The Z coordinate of the maximum point of the measured groove in the three dimensional space.
- **Right point x:** The X coordinate of the right point of the measured groove in the three dimensional space.
- **Right point y:** The Y coordinate of the right point of the measured groove in the three dimensional space.
- **Right point z:** The Z coordinate of the right point of the measured groove in the three dimensional space.
- **Left point u:** The U coordinate of the left point of the measured groove in the two dimensional space.
- **Left point v:** The V coordinate of the left point of the measured groove in the two dimensional space.
- **Minimum point u:** The U coordinate of the minimum point of the measured groove in the two dimensional space.
- **Minimum point v:** The V coordinate of the minimum point of the measured groove in the two dimensional space.
- **Right point u:** The U coordinate of the right point of the measured groove in the two dimensional space.

- **Right point v:** The V coordinate of the right point of the measured groove in the two dimensional space.
- **Area:** The area of the measured groove related to reference circle.
- **Number of points:** The number of points in the 2D profile which have been used for measuring the groove.

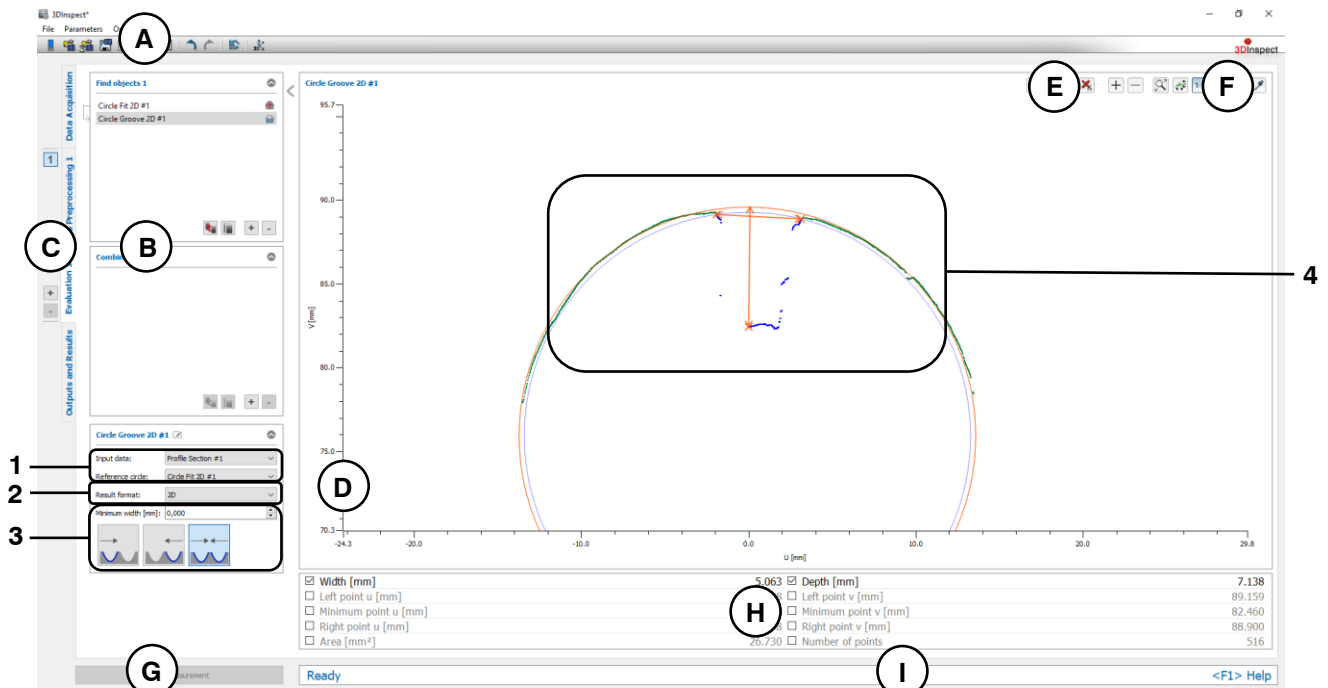

Fig. 6.27: "Circle Groove 2D" Measuring Program

Display Elements and Parameters in the "Circle Groove 2D" Program:

- A "General" toolbar:** Using this toolbar, you can select the data source (see Chapter 3.4 and 3.5), save and load parameters (see Chapter 3.20), reset selected parameters to default settings (see Chapter 3.20.3) and undo and restore changes of settings and parameters (see Chapter 3.21).
- B List of active measuring programs:** This section displays the active measuring programs from the "Find objects" and "Combine objects" groups. You can add and remove measuring programs/measuring program groups (see Chapter 3.15 and 3.17), move measuring programs (see Chapter 3.16) and select an active measuring program for parameterizing and displaying the measured values.
- C Measuring program groups / Tab bar for switching between views:** This tab bar allows you to switch between the four main views (see Chapter 3.2). To the left of the tab bar you find the section for adding, removing and selecting measuring program groups (see Chapter 3.17).
- D 2D Profile View:** The 2D Profile View visualizes the 2D data (see Chapter 3.13).
- E "Measuring" toolbar:** Use this toolbar to set various ROIs for the measurement (see Chapter 3.18.5, 3.18.6 and 3.18.7).
- F "2D Profile View" toolbar:** Use this toolbar to scale the 2D Profile View and activate various options for mouse interaction (see Chapter 3.13).
- G "Start measurement" button:** Click on this button to perform a measuring operation, calculate the measurement results and display the profile and measurement results of the currently selected measuring program in the 2D Profile View.
- H Results display:** The measurement results of the currently selected measuring program are displayed. Here, you can select which measured values are to be made available later for calculation, OK/nOK assessment, logging and output (see Chapter 3.18.9).
- I Status bar:** Status and error messages are displayed in the status bar (see Chapter 8.1).

- 1 **Input data:** Use this selection field to select the input data and the reference circle for the program (see also Chapter 3.18.3). An overview of measuring programs which provide 2D circles can be found in Chapter 3.19.4.
- 2 **Result format:** Choose whether the measured values are to be output in the two or three dimensional space. This affects the results display, the calculating, assessing, logging and output of the measured values.
- 3
 - **Minimum width:** Define the minimum width (euclidean) for the groove.
 - **Search direction:** Define the search direction for detecting the groove (see Fig. 6.23):
 - From left: The groove is searched from the left.
 - From right: The groove is searched from the left.
 - From left and right: The groove is searched from the left and right.
- 4 **2D Profile View:** In the 2D profile view, the left, right and highest points of the groove as well as the height and width are drawn in orange. The points associated with the groove are displayed in blue. The reference and threshold circles are displayed in orange and blue, respectively. The points that were used to determine the groove are drawn in green. The discarded points are displayed in gray.

6.1.25 "Gap 2D" Measuring Program

Use the "Gap 2D" program to determine the largest gap in a 2D profile.

Note: The "Gap 2D" program needs a 2D profile as input data. The "Profile Section" measuring program can be used in order to generate a 2D profile. (see Chapter [5.1.19](#))

Proceed as follows:

- If applicable, select the input data for the program (see below, section "1" and Chapter [3.18.3](#)).
- If necessary, limit the range for the gap calculation in order to eliminate interfering points (see section "E" and Chapter [3.18.5](#), [3.18.6](#) and [3.18.7](#)).
- Define the minimum width (euclidean, in X or Z direction) for the gap (see below, area "3").
- If applicable, select measured values that are to be used later for calculation, OK/nOK assessment, logging and output (see below, section "H" and Chapter [3.18.9](#)).

The measuring program outputs the following measured values:

- **Distance euclidean:** The euclidean distance between the left and right points of the measured gap.
- **Distance x:** The distance between the left and right points of the measured gap in X direction in the two dimensional space.
- **Distance z:** The distance between the left and right points of the measured gap in Z direction in the two dimensional space.
- **Left point x:** The X coordinate of the left point of the measured gap in the three dimensional space.
- **Left point y:** The Y coordinate of the left point of the measured gap in the three dimensional space.
- **Left point z:** The Z coordinate of the left point of the measured gap in the three dimensional space.
- **Right point x:** The X coordinate of the right point of the measured gap in the three dimensional space.
- **Right point y:** The Y coordinate of the right point of the measured gap in the three dimensional space.
- **Right point z:** The Z coordinate of the right point of the measured gap in the three dimensional space.
- **Distance u:** The distance between the left and right points of the measured gap in U direction in the two dimensional space.
- **Distance v:** The distance between the left and right points of the measured gap in V direction in the two dimensional space.
- **Left point u:** The U coordinate of the left point of the measured gap in the two dimensional space.
- **Left point v:** The V coordinate of the left point of the measured gap in the two dimensional space.
- **Right point u:** The U coordinate of the right point of the measured gap in the two dimensional space.
- **Right point v:** The V coordinate of the right point of the measured gap in the two dimensional space.
- **Number of points:** The number of points in the 2D profile which have been used for measuring the gap.

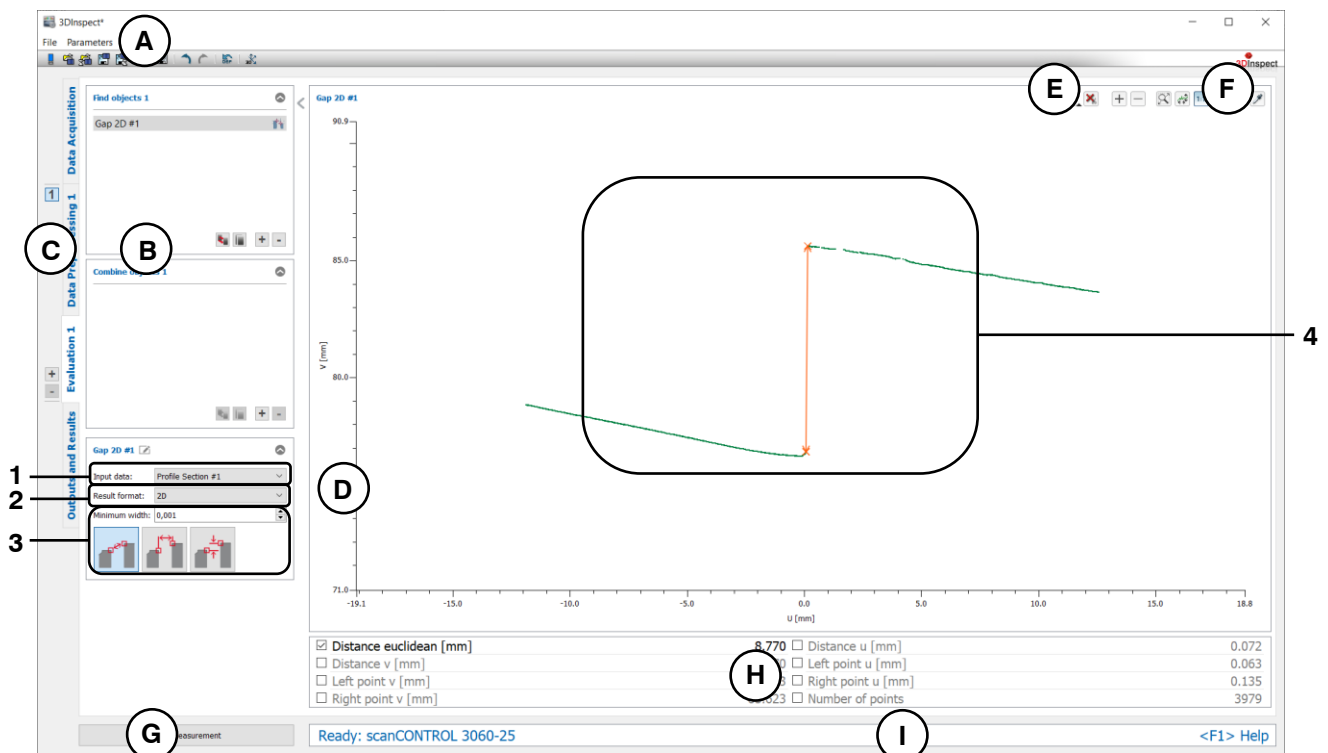

Fig. 6.28: "Gap 2D" Measuring Program

Display Elements and Parameters in the "Gap 2D" Program:

- A "General" toolbar:** Using this toolbar, you can select the data source (see Chapter 3.4 and 3.5), save and load parameters (see Chapter 3.20), reset selected parameters to default settings (see Chapter 3.20.3) and undo and restore changes of settings and parameters (see Chapter 3.21).
- B List of active measuring programs:** This section displays the active measuring programs from the "Find objects" and "Combine objects" groups. You can add and remove measuring programs/measuring program groups (see Chapter 3.15 and 3.17), move measuring programs (see Chapter 3.16) and select an active measuring program for parameterizing and displaying the measured values.
- C Measuring program groups / Tab bar for switching between views:** This tab bar allows you to switch between the four main views (see Chapter 3.2). To the left of the tab bar you find the section for adding, removing and selecting measuring program groups (see Chapter 3.17).
- D 2D Profile View:** The 2D Profile View visualizes the 2D data (see Chapter 3.13).
- E "Measuring" toolbar:** Use this toolbar to set various ROIs for the measurement (see Chapter 3.18.5, 3.18.6 and 3.18.7).
- F "2D Profile View" toolbar:** Use this toolbar to scale the 2D Profile View and activate various options for mouse interaction (see Chapter 3.13).
- G "Start measurement" button:** Click on this button to perform a measuring operation, calculate the measurement results and display the profile and measurement results of the currently selected measuring program in the 2D Profile View.
- H Results display:** The measurement results of the currently selected measuring program are displayed. Here, you can select which measured values are to be made available later for calculation, OK/nOK assessment, logging and output (see Chapter 3.18.9).
- I Status bar:** Status and error messages are displayed in the status bar (see Chapter 8.1).
- 1 Input data:** Use this selection field to select the input data for the program (see also Chapter 3.18.3).

- 2 Result format:** Choose whether the measured values are to be output in the two or three dimensional space. This affects the results display, the calculating, assessing, logging and output of the measured values.
- 3 Minimum width:** Define the minimum width for the gap in the selected direction to be detected.
- 4 2D Profile View:** In the 2D profile view, the left and right points of the gap as well as the euclidean distance are drawn in orange. The points that were used to determine the gap are drawn in green. The discarded points are displayed in gray.

6.2 Description of the Measuring Programs in the "Combine Objects" Group

In this group, you will find programs for relating previously found objects to one another.

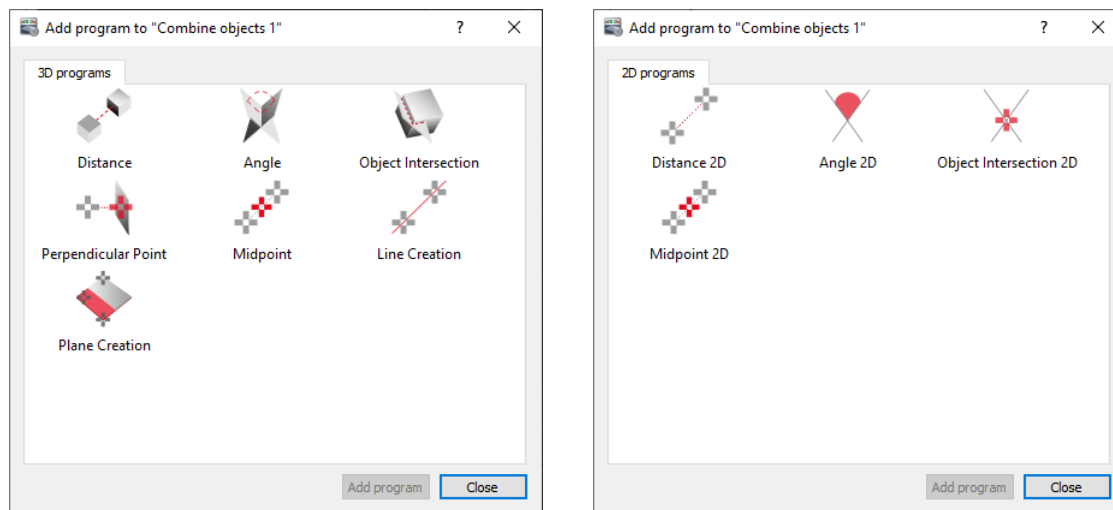

Fig. 6.29: "Combine objects" group

Measuring Programs in the "Combine Objects" Group:

- Distance: Calculate the distance between two objects (see Chapter 6.2.1).
- Angle: Calculate the angle difference between two objects (see Chapter 6.2.2).
- Object Intersection: Calculate a new geometric object by intersection of two objects (see Chapter 6.2.3).
- Perpendicular Point: Calculate a point by an orthogonal projection from a point to a plane or a line (see Chapter 6.2.4).
- Midpoint: Calculate the midpoint from two points (see Chapter 6.2.5).
- Line Creation: Create a straight line from two points (see Chapter 6.2.6).
- Plane Creation: Create a straight line from two points (see Chapter 6.2.7).
- Distance 2D: Calculate the distance between two 2D objects (see Chapter 6.2.8).
- Angle 2D: Calculate the angle difference between two 2D straight lines (see Chapter 6.2.9).
- Object Intersection 2D: Calculate one or two 2D points by intersection of two 2D objects (see Chapter 6.2.10).
- Midpoint 2D: Calculate the midpoint from two 2D points (see Chapter 6.2.11).

6.2.1 "Distance" Measuring Program

Use the "Distance" program to calculate the distance between two objects. Proceed as follows:

- Select the type of distance to be calculated (see below, section "1" and Chapter 3.18.2)
- If applicable, select the input data for the program (see below, section "2" and Chapter 3.18.3). The available input data vary depending on the type of distance.
- If applicable, configure further measuring program parameters depending on the type of distance and the input data (see below, section "3").
- If applicable, select measured values that are to be used later for calculation, OK/nOK assessment, logging and output (see below, section "G" and Chapter 3.18.9).

The measuring program outputs the following measured values:

- **Euclidean distance:** The Euclidean distance between the selected objects.
- **Distance x:** The distance between the selected objects in the x direction.
- **Distance y:** The distance between the selected objects in the y direction.
- **Distance z:** The distance between the selected objects in the z direction.

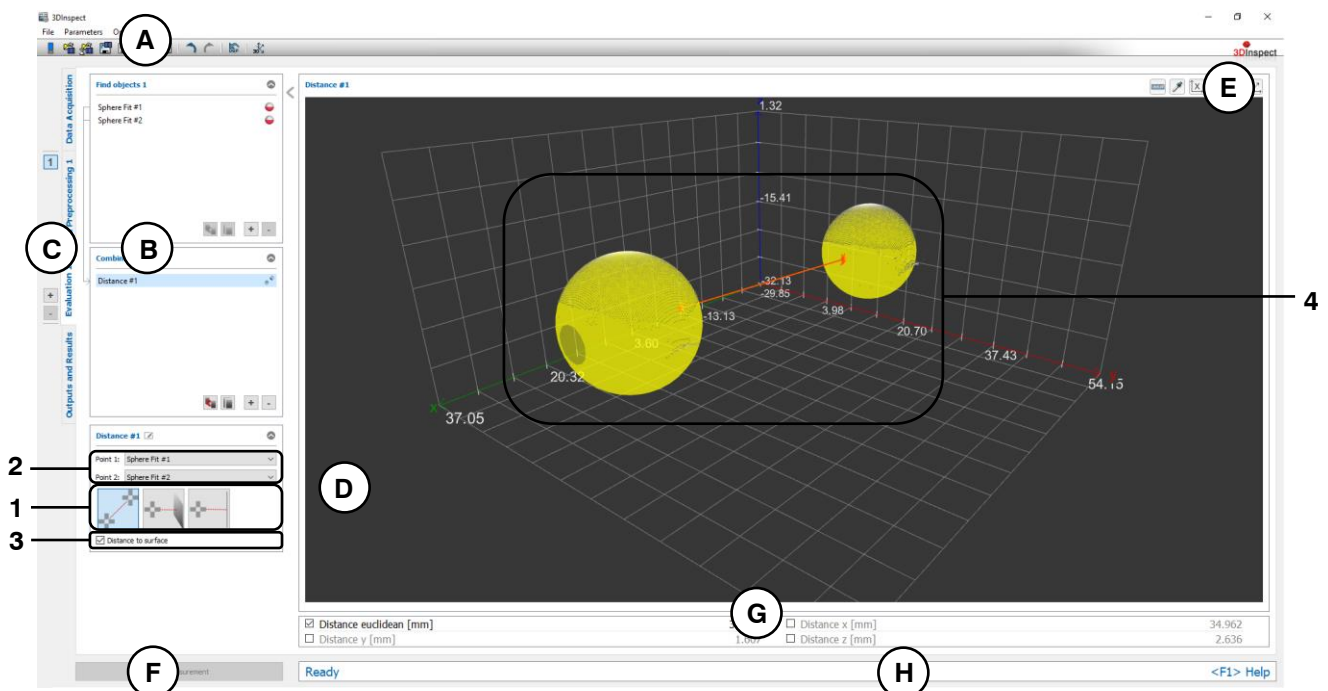

Fig. 6.30: "Distance" Measuring Program

Display Elements and Parameters in the "Distance" Program:

- A "General" toolbar:** Using this toolbar, you can select the data source (see Chapter 3.4 and 3.5), save and load parameters (see Chapter 3.20), reset selected parameters to default settings (see Chapter 3.20.3) and undo and restore changes of settings and parameters (see Chapter 3.21).
- B List of active measuring programs:** This section displays the active measuring programs from the "Find objects" and "Combine objects" groups. You can add and remove measuring programs/measuring program groups (see Chapter 3.15 and 3.17), move measuring programs (see Chapter 3.16) and select an active measuring program for parameterizing and displaying the measured values.
- C Measuring program groups / Tab bar for switching between views:** This tab bar allows you to switch between the four main views (see Chapter 3.2). To the left of the tab bar you find the section for adding, removing and selecting measuring program groups (see Chapter 3.17).
- D 3D-View:** The 3D-View visualizes the 3D data (see Chapter 3.11).
- E "3D-View" toolbar:** Use this toolbar to configure the orientation of the coordinate system and activate various options for mouse interaction in the 3D-View (see Chapter 3.11).

- F** **"Start measurement" button:** Click on this button to perform a measuring operation, calculate the measurement results and display the point cloud and measurement results of the currently selected measuring program in the 3D-View.
- G** **Results display:** The measurement results of the currently selected measuring program are displayed. Here, you can select which measured values are to be made available later for calculation, OK/nOK assessment, logging and output (see Chapter 3.18.9).
- H** **Status bar:** Status and error messages are displayed in the status bar (see Chapter 8.1).
- 1** **Distance type:** Select the type of distance to be calculated:
- **Distance between two points**
 - **Distance between point and plane**
 - **Distance between point and straight line**
- An overview of measuring programs, which provide points, lines and planes, can be found in Chapter 3.19.1, 3.19.2 and 3.19.3.
- 2** **Input data:** Use this selection field to select the input objects for the program (see also Chapter 3.18.3). The available input data vary depending on the type of distance
- 3** **Parameters:** The measuring program offers other parameters depending on the type of distance and selected input objects:
- **Distance from surface:** When you use spheres, cones and cylinders, you can choose whether the distance from the center point or longitudinal axis or from the surface of the relevant object is calculated.
 - **Signed distance:** You can choose whether to output the signed distance or the absolute distance value. This parameter is available for the following distance types:
 - Distance between two points when a point and sphere are used and the "Distance from surface" option is activated (point inside/outside sphere)
 - Distance between point and plane (point above/below the plane)
 - Distance between point and line when a point, cone and cylinder are used and the "Distance from surface" option is activated (point inside/outside cylinder or cone)
- 4** **3D-View:** The 3D-View displays the input objects and the distance between the objects as an orange arrow.

6.2.2 "Angle" Measuring Program

Use the "Angle" program to calculate the angle between two objects. Proceed as follows:

- Select the type of angle to be calculated (see below, section "1" and Chapter 3.18.2)
- If applicable, select the input data for the program (see below, section "2" and Chapter 3.18.3). The available input data vary depending on the type of angle.
- If applicable, configure further measuring program parameters (see below, section "3").
- If applicable, select measured values that are to be used later for calculation, OK/nOK assessment, logging and output (see below, section "G" and Chapter 3.18.9).

The measuring program outputs the following measured value:

- **Angle:** The angle between the selected objects.

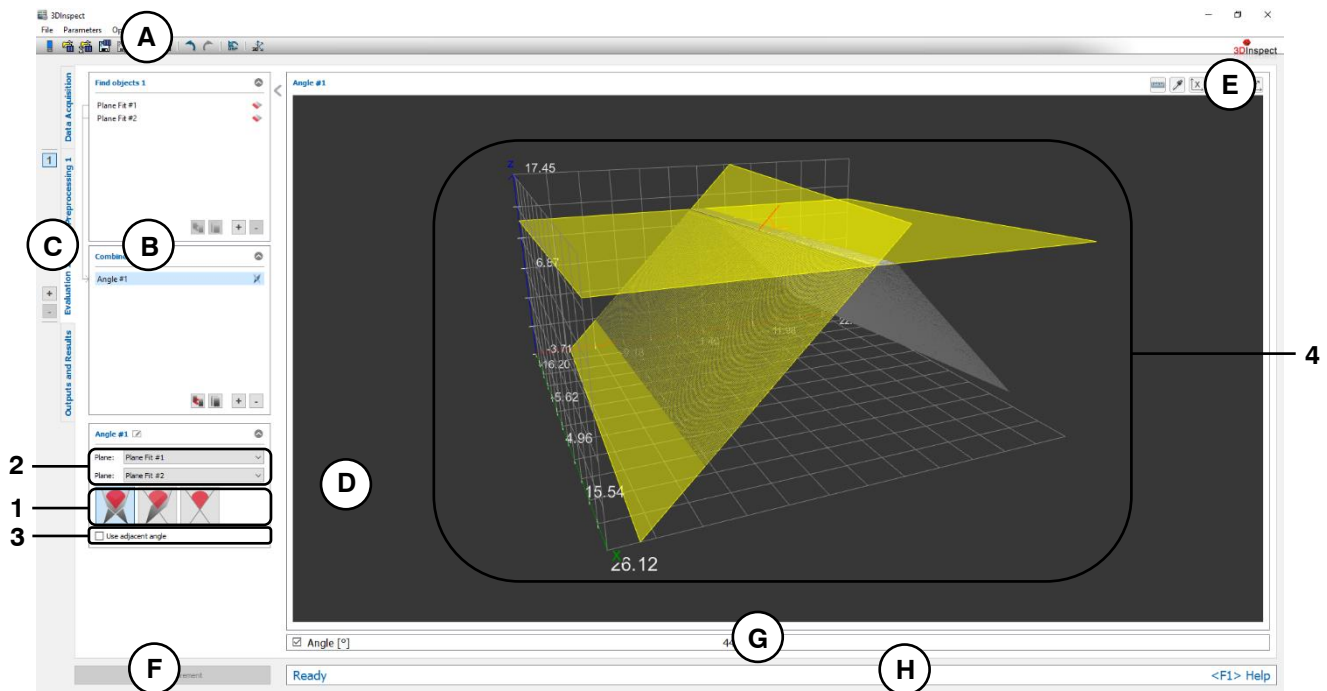

Fig. 6.31: "Angle" Measuring Program

Display Elements and Parameters in the "Angle" Program:

- A "General" toolbar:** Using this toolbar, you can select the data source (see Chapter 3.4 and 3.5), save and load parameters (see Chapter 3.20), reset selected parameters to default settings (see Chapter 3.20.3) and undo and restore changes of settings and parameters (see Chapter 3.21).
- B List of active measuring programs:** This section displays the active measuring programs from the "Find objects" and "Combine objects" groups. You can add and remove measuring programs/measuring program groups (see Chapter 3.15 and 3.17), move measuring programs (see Chapter 3.16) and select an active measuring program for parameterizing and displaying the measured values.
- C Measuring program groups / Tab bar for switching between views:** This tab bar allows you to switch between the four main views (see Chapter 3.2). To the left of the tab bar you find the section for adding, removing and selecting measuring program groups (see Chapter 3.17).
- D 3D-View:** The 3D-View visualizes the 3D data (see Chapter 3.11).
- E "3D-View" toolbar:** Use this toolbar to configure the orientation of the coordinate system and activate various options for mouse interaction in the 3D-View (see Chapter 3.11).
- F "Start measurement" button:** Click on this button to perform a measuring operation, calculate the measurement results and display the point cloud and measurement results of the currently selected measuring program in the 3D-View.

- G Results display:** The measurement results of the currently selected measuring program are displayed. Here, you can select which measured values are to be made available later for calculation, OK/nOK assessment, logging and output (see Chapter [3.18.9](#)).
- H Status bar:** Status and error messages are displayed in the status bar (see Chapter [8.1](#)).
- 1 Angle type:** Select the type of angle to be calculated:
- **Angle between two planes:** The value range for the angle is 0 to 180 degrees.
 - **Angle between plane and straight line:** The value range for the angle is 0 to 90 degrees.
 - **Angle between two lines:** The value range for the angle is 0 to 90 degrees.
- An overview of measuring programs, which provide lines and planes, can be found in Chapter [3.19.2](#) and [3.19.3](#).
- 2 Input data:** Use this selection field to select the input objects for the program (see also Chapter [3.18.3](#)). The available input data vary depending on the type of distance.
- 3 Use adjacent angle:** Specify whether the adjacent angle should be used as the measurement result.
- 4 3D-View:** The 3D-View displays the input objects and the angle between the objects as an orange arc.

6.2.3 "Object Intersection" Measuring Program

Use the "Object Intersection" program to calculate a new object by intersecting two objects. Proceed as follows:

- Select the type of intersection to be carried out and, if necessary, the maximum distance between two 3D lines (for section type "Calculating a point by intersecting two lines") (see below, section "1" and Chapter 3.18.2).
- If applicable, select the input data for the program (see below, section "2" and Chapter 3.18.3). The available input data vary depending on the type of intersection.
- If applicable, select measured values that are to be used later for calculation, OK/nOK assessment, logging and output (see below, section "G" and Chapter 3.18.9).

The measuring program outputs the following measured values depending on the type of intersection:

- **Calculating a straight line by intersecting two planes:**
 - **Line angle to x/y plane:** Angle of the intersection line with respect to the X/Y plane
 - **Line angle to y/z plane:** Angle of the intersection line with respect to the Y/Z plane
 - **Line angle to z/x plane:** Angle of the intersection line with respect to the Z/X plane
 - **Direction x:** The X component of the direction vector of the intersection line.
 - **Direction y:** The Y component of the direction vector of the intersection line.
 - **Direction z:** The Z component of the direction vector of the intersection line.
- **Calculating a point by intersecting a plane with a straight line:**
 - **Point x:** The X coordinate of the point of intersection
 - **Point y:** The Y coordinate of the point of intersection
 - **Point z:** The Z coordinate of the point of intersection
- **Calculating a point by intersecting two lines:**
 - **Point x:** The X coordinate of the point of intersection
 - **Point y:** The Y coordinate of the point of intersection
 - **Point z:** The Z coordinate of the point of intersection

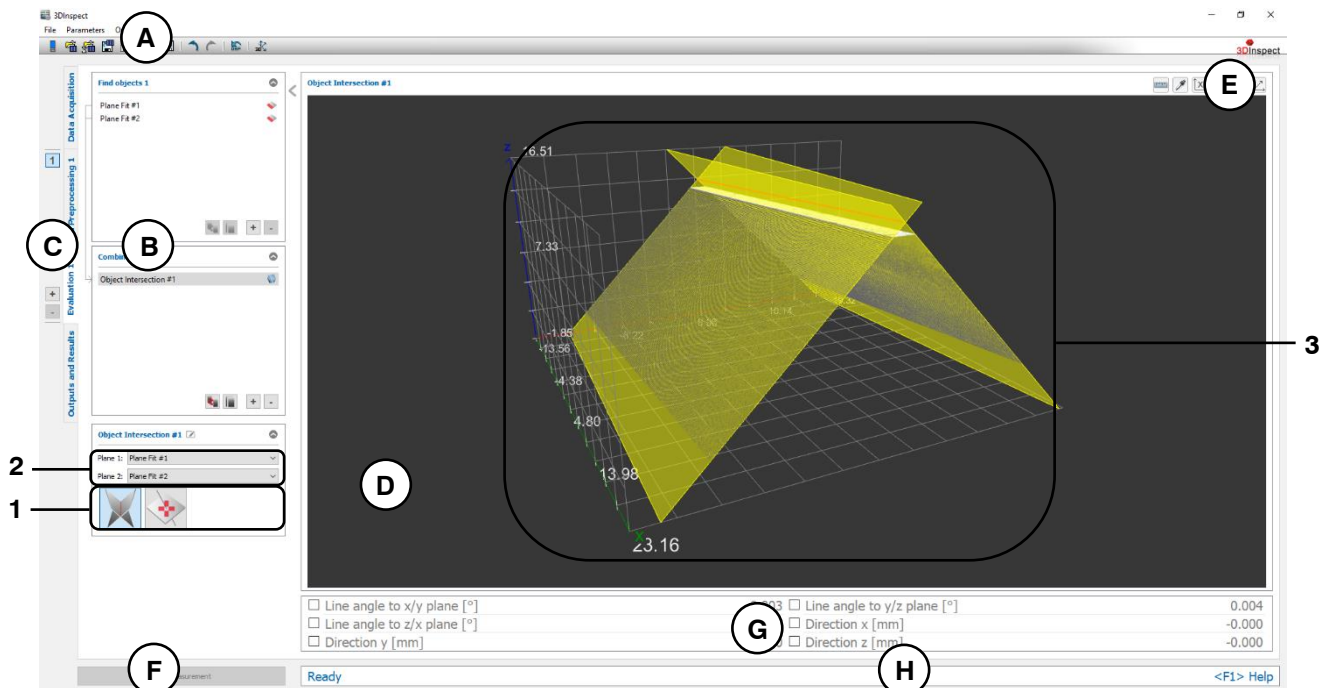

Fig. 6.32: "Object Intersection" Measuring Program

Display Elements and Parameters in the "Object Intersection" Program:

- A** **"General" toolbar:** Using this toolbar, you can select the data source (see Chapter 3.4 and 3.5), save and load parameters (see Chapter 3.20), reset selected parameters to default settings (see Chapter 3.20.3) and undo and restore changes of settings and parameters (see Chapter 3.21).

- B List of active measuring programs:** This section displays the active measuring programs from the "Find objects" and "Combine objects" groups. You can add and remove measuring programs/measuring program groups (see Chapter 3.15 and 3.17), move measuring programs (see Chapter 3.16) and select an active measuring program for parameterizing and displaying the measured values.
- C Measuring program groups / Tab bar for switching between views:** This tab bar allows you to switch between the four main views (see Chapter 3.2). To the left of the tab bar you find the section for adding, removing and selecting measuring program groups (see Chapter 3.17).
- D 3D-View:** The 3D-View visualizes the 3D data (see Chapter 3.11).
- E "3D-View" toolbar:** Use this toolbar to configure the orientation of the coordinate system and activate various options for mouse interaction in the 3D-View (see Chapter 3.11).
- F "Start measurement" button:** Click on this button to perform a measuring operation, calculate the measurement results and display the point cloud and measurement results of the currently selected measuring program in the 3D-View.
- G Results display:** The measurement results of the currently selected measuring program are displayed. Here, you can select which measured values are to be made available later for calculation, OK/nOK assessment, logging and output (see Chapter 3.18.9).
- H Status bar:** Status and error messages are displayed in the status bar (see Chapter 8.1).
- 1**
- **Intersection type:** Select the type of intersection to be carried out:
 - **Calculating a straight line by intersecting two planes**
 - **Calculating a point by intersecting a plane with a straight line**
 - **Calculating a point by intersecting two lines**
 - **Max. distance [mm]:** Specifies the maximum valid value for the shortest distance of the two lines for which an intersection point is calculated for the intersection type "Line/Line".
- An overview of measuring programs, which provide lines and planes, can be found in Chapter 3.19.2 and 3.19.3.
- 2 Input data:** Use this selection field to select the input objects for the program (see also Chapter 3.18.3). The available input data vary depending on the type of intersection.
- 3 3D-View:** The 3D-View displays the input objects (yellow) and the resulting object (orange).

6.2.4 "Perpendicular Point" Measuring Program

Use the "Perpendicular Point" program to project a point by means of orthogonal projection onto a plane or line. Proceed as follows:

- Select the type of projection to be carried out (see below, section "1" and Chapter 3.18.2)
- If applicable, select the input data for the program (see below, section "2" and Chapter 3.18.3). The available input data vary depending on the type of projection.
- If applicable, select measured values that are to be used later for calculation, OK/nOK assessment, logging and output (see below, section "G" and Chapter 3.18.9).

The measuring program outputs the following measured values:

- **Perpendicular point x:** The X coordinate of the perpendicular point
- **Perpendicular point y:** The Y coordinate of the perpendicular point
- **Perpendicular point z:** The Z coordinate of the perpendicular point

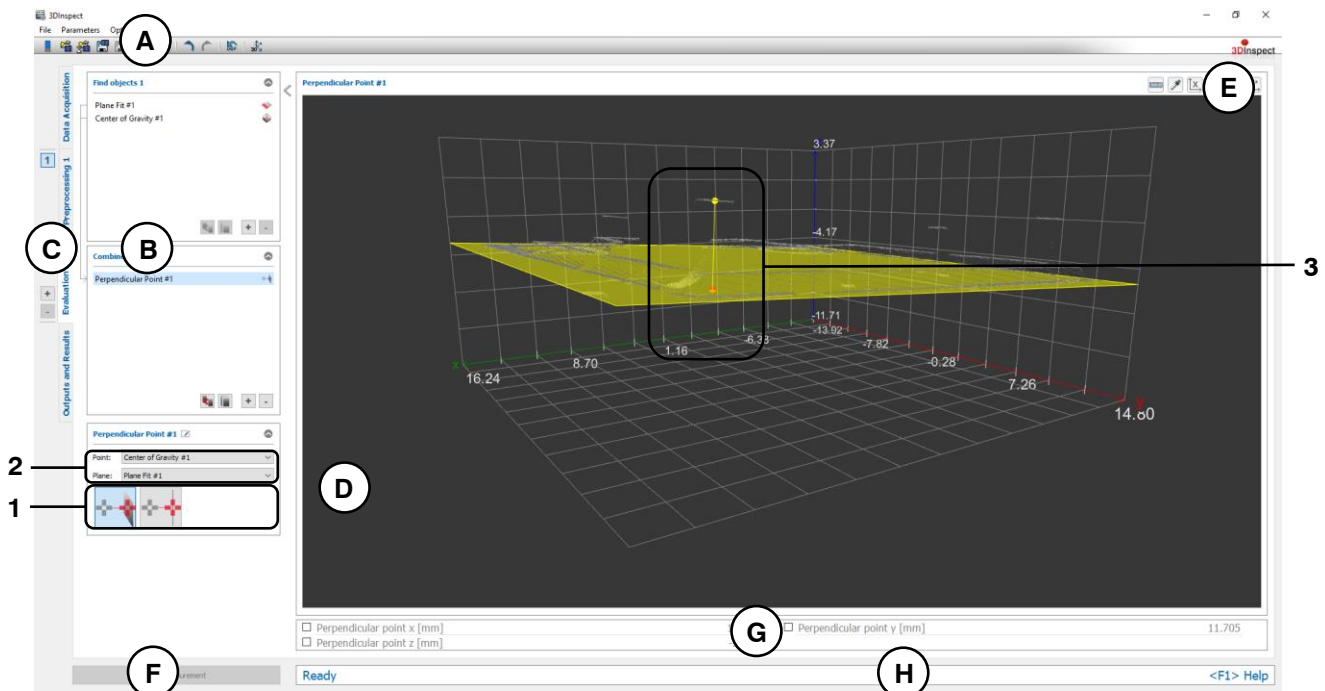

Fig. 6.33: "Perpendicular Point" Measuring Program

Display Elements and Parameters in the "Perpendicular Point" Program:

- A "General" toolbar:** Using this toolbar, you can select the data source (see Chapter 3.4 and 3.5), save and load parameters (see Chapter 3.20), reset selected parameters to default settings (see Chapter 3.20.3) and undo and restore changes of settings and parameters (see Chapter 3.21).
- B List of active measuring programs:** This section displays the active measuring programs from the "Find objects" and "Combine objects" groups. You can add and remove measuring programs/measuring program groups (see Chapter 3.15 and 3.17), move measuring programs (see Chapter 3.16) and select an active measuring program for parameterizing and displaying the measured values.
- C Measuring program groups / Tab bar for switching between views:** This tab bar allows you to switch between the four main views (see Chapter 3.2). To the left of the tab bar you find the section for adding, removing and selecting measuring program groups (see Chapter 3.17).
- D 3D-View:** The 3D-View visualizes the 3D data (see Chapter 3.11).
- E "3D-View" toolbar:** Use this toolbar to configure the orientation of the coordinate system and activate various options for mouse interaction in the 3D-View (see Chapter 3.11).
- F "Start measurement" button:** Click on this button to perform a measuring operation, calculate the measurement results and display the point cloud and measurement results of the currently selected measuring program in the 3D-View.

- G Results display:** The measurement results of the currently selected measuring program are displayed. Here, you can select which measured values are to be made available later for calculation, OK/nOK assessment, logging and output (see Chapter [3.18.9](#)).
- H Status bar:** Status and error messages are displayed in the status bar (see Chapter [8.1](#)).
- 1 Projection type:** Select the type of projection to be carried out:
- **Calculating a point by means of orthogonal projection onto a plane**
 - **Calculating a point by means of orthogonal projection onto a straight line**
- An overview of measuring programs, which provide points, lines and planes, can be found in Chapter [3.19.1](#), [3.19.2](#) and [3.19.3](#).
- 2 Input data:** Use this selection field to select the input objects for the program (see also Chapter [3.18.3](#)). The available input data vary depending on the type of distance.
- 3 3D-View:** The 3D-View displays the input objects (yellow) and the projected point (orange).

6.2.5 "Midpoint" Measuring Program

Use the "Midpoint" program to calculate the midpoint from two selected points. Proceed as follows:

- If applicable, select the input data for the program (see below, section "1" and Chapter 3.18.3).
- If applicable, select measured values that are to be used later for calculation, OK/nOK assessment, logging and output (see below, section "G" and Chapter 3.18.9).

The measuring program outputs the following measured values:

- **Midpoint x:** The X coordinate of the perpendicular point
- **Midpoint y:** The Y coordinate of the perpendicular point
- **Midpoint z:** The Z coordinate of the perpendicular point

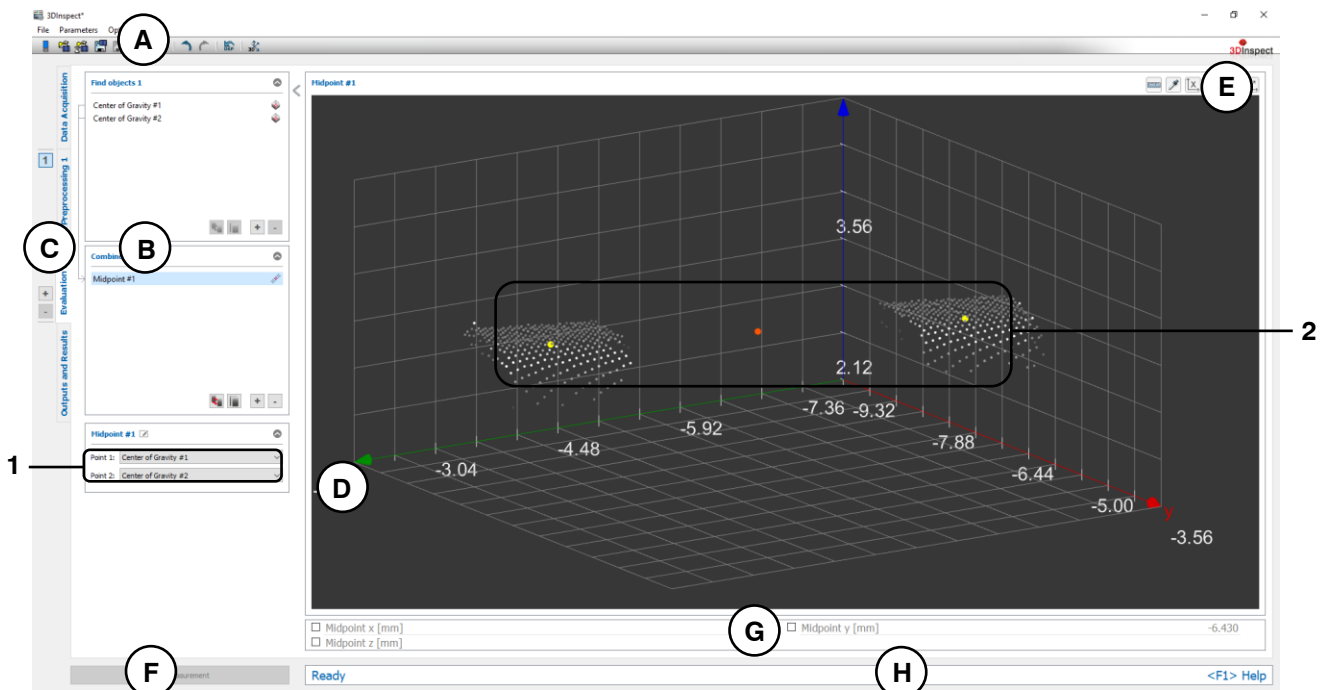

Fig. 6.34: "Midpoint" Measuring Program

Display Elements and Parameters in the "Midpoint" Program:

- A "General" toolbar:** Using this toolbar, you can select the data source (see Chapter 3.4 and 3.5), save and load parameters (see Chapter 3.20), reset selected parameters to default settings (see Chapter 3.20.3) and undo and restore changes of settings and parameters (see Chapter 3.21).
- B List of active measuring programs:** This section displays the active measuring programs from the "Find objects" and "Combine objects" groups. You can add and remove measuring programs/measuring program groups (see Chapter 3.15 and 3.17), move measuring programs (see Chapter 3.16) and select an active measuring program for parameterizing and displaying the measured values.
- C Measuring program groups / Tab bar for switching between views:** This tab bar allows you to switch between the four main views (see Chapter 3.2). To the left of the tab bar you find the section for adding, removing and selecting measuring program groups (see Chapter 3.17).
- D 3D-View:** The 3D-View visualizes the 3D data (see Chapter 3.11).
- E "3D-View" toolbar:** Use this toolbar to configure the orientation of the coordinate system and activate various options for mouse interaction in the 3D-View (see Chapter 3.11).
- F "Start measurement" button:** Click on this button to perform a measuring operation, calculate the measurement results and display the point cloud and measurement results of the currently selected measuring program in the 3D-View.

- G Results display:** The measurement results of the currently selected measuring program are displayed. Here, you can select which measured values are to be made available later for calculation, OK/nOK assessment, logging and output (see Chapter [3.18.9](#)).
- H Status bar:** Status and error messages are displayed in the status bar (see Chapter [8.1](#)).

- 1 Input data:** Use this selection field to select the input objects for the program (see also Chapter [3.18.3](#)). An overview of measuring programs, which provide points, can be found in Chapter [3.19.1](#).
- 2 3D-View:** The 3D-View displays the input points (orange) and the mid point (yellow).

6.2.6 "Line Creation" Measuring Program

Use the "Line Creation" to create a straight line from two selected points. Proceed as follows:

- If applicable, select the input data for the program (see below, section "1" and Chapter 3.18.3)
- If applicable, select measured values that are to be used later for calculation, OK/nOK assessment, logging and output (see below, section "G" and Chapter 3.18.9).

The measuring program outputs the following measured values:

- **Line angle to x/y plane:** Angle of the straight line with respect to the X/Y plane.
- **Line angle to y/z plane:** Angle of the straight line with respect to the Y/Z plane.
- **Line angle to z/x plane:** Angle of the straight line with respect to the Z/X plane.
- **Direction x:** The X component of the direction vector of the line.
- **Direction y:** The Y component of the direction vector of the line.
- **Direction z:** The Z component of the direction vector of the line.

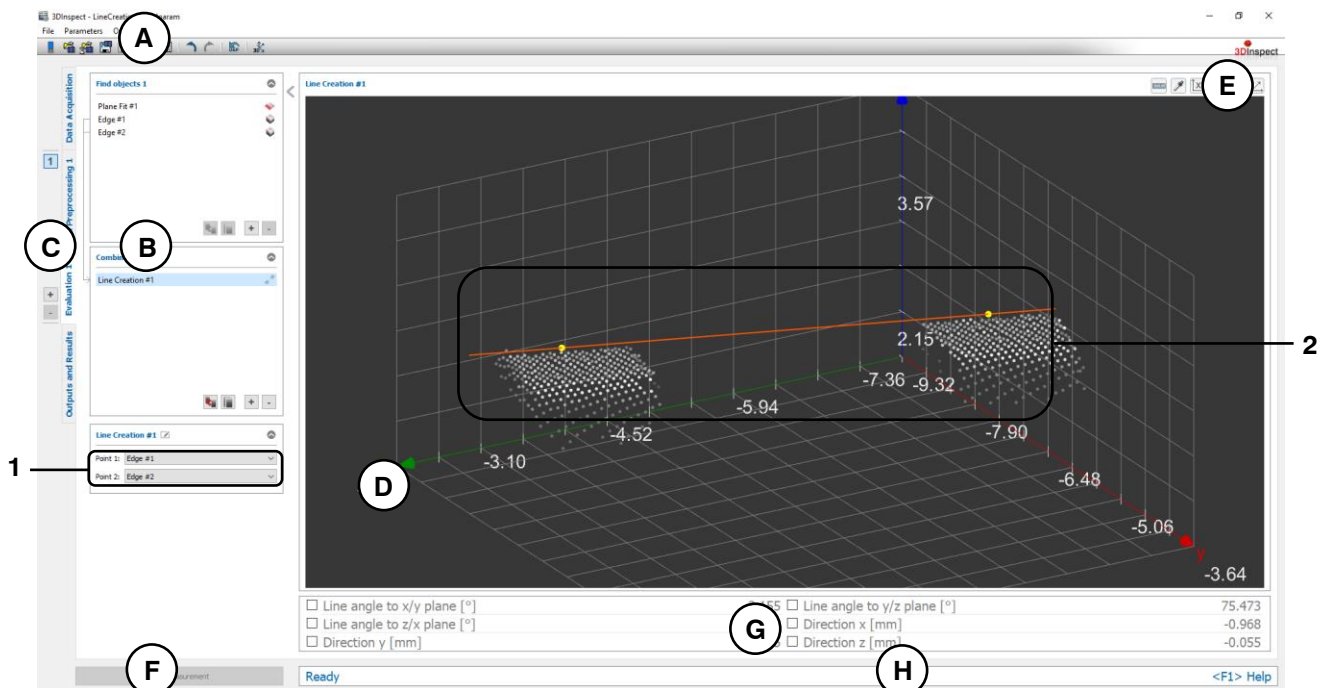

Fig. 6.35: "Line Creation" Measuring Program

Display Elements and Parameters in the "Line Creation" Program:

- A "General" toolbar:** Using this toolbar, you can select the data source (see Chapter 3.4 and 3.5), save and load parameters (see Chapter 3.20), reset selected parameters to default settings (see Chapter 3.20.3) and undo and restore changes of settings and parameters (see Chapter 3.21).
- B List of active measuring programs:** This section displays the active measuring programs from the "Find objects" and "Combine objects" groups. You can add and remove measuring programs/measuring program groups (see Chapter 3.15 and 3.17), move measuring programs (see Chapter 3.16) and select an active measuring program for parameterizing and displaying the measured values.
- C Measuring program groups / Tab bar for switching between views:** This tab bar allows you to switch between the four main views (see Chapter 3.2). To the left of the tab bar you find the section for adding, removing and selecting measuring program groups (see Chapter 3.17).
- D 3D-View:** The 3D-View visualizes the 3D data (see Chapter 3.11).
- E "3D-View" toolbar:** Use this toolbar to configure the orientation of the coordinate system and activate various options for mouse interaction in the 3D-View (see Chapter 3.11).

- F** **"Start measurement" button:** Click on this button to perform a measuring operation, calculate the measurement results and display the point cloud and measurement results of the currently selected measuring program in the 3D-View.
- G** **Results display:** The measurement results of the currently selected measuring program are displayed. Here, you can select which measured values are to be made available later for calculation, OK/nOK assessment, logging and output (see Chapter [3.18.9](#)).
- H** **Status bar:** Status and error messages are displayed in the status bar (see Chapter [8.1](#)).

- 1** **Input data:** Use this selection field to select the input objects for the program (see also Chapter [3.18.3](#)). An overview of measuring programs, which provide points, can be found in Chapter [3.19.1](#).
- 2** **3D-View:** The 3D-View displays the input points (yellow) and the resulting straight line (orange).

6.2.7 "Plane Creation" Measuring Program

Use the "Plane Creation" to create a plane from three selected points. Proceed as follows:

- If applicable, select the input data for the program (see below, section "1" and Chapter 3.18.3)
- If applicable, select measured values that are to be used later for calculation, OK/nOK assessment, logging and output (see below, section "G" and Chapter 3.18.9).

The measuring program outputs the following measured values:

- **Angle to x axis:** The angle of the calculated plane with respect to the X axis.
- **Angle to y axis:** The angle of the calculated plane with respect to the Y axis.
- **Angle to z axis:** The angle of the calculated plane with respect to the Z axis.
- **Distance to origin:** The distance between the plane and the origin of the coordinate system.
- **Center of gravity x:** The X coordinate of the center of gravity of the points that were used to calculate the plane.
- **Center of gravity y:** The Y coordinate of the center of gravity of the points that were used to calculate the plane.
- **Center of gravity z:** The Z coordinate of the center of gravity of the points that were used to calculate the plane.

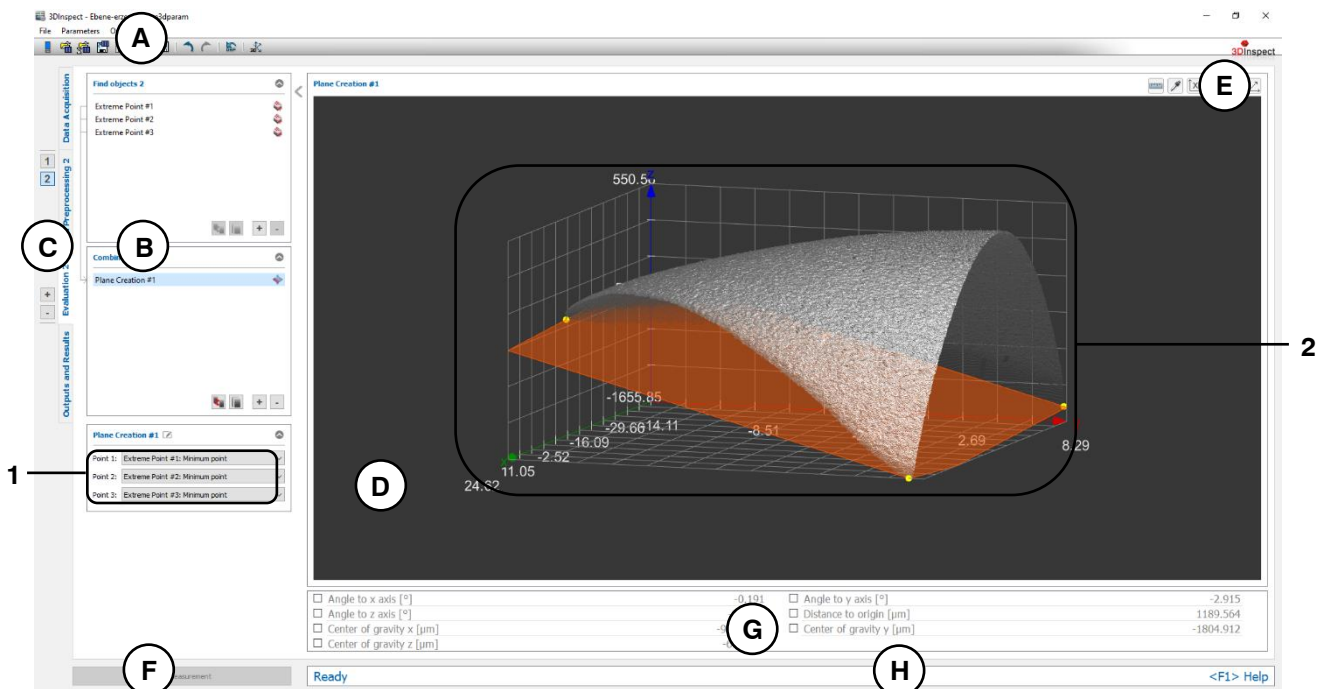

Fig. 6.36: "Plane Creation" Measuring Program

Display Elements and Parameters in the "Plane Creation" Program:

- A "General" toolbar:** Using this toolbar, you can select the data source (see Chapter 3.4 and 3.5), save and load parameters (see Chapter 3.20), reset selected parameters to default settings (see Chapter 3.20.3) and undo and restore changes of settings and parameters (see Chapter 3.21).
- B List of active measuring programs:** This section displays the active measuring programs from the "Find objects" and "Combine objects" groups. You can add and remove measuring programs/measuring program groups (see Chapter 3.15 and 3.17), move measuring programs (see Chapter 3.16) and select an active measuring program for parameterizing and displaying the measured values.
- C Measuring program groups / Tab bar for switching between views:** This tab bar allows you to switch between the four main views (see Chapter 3.2). To the left of the tab bar you find the section for adding, removing and selecting measuring program groups (see Chapter 3.17).

- D 3D-View:** The 3D-View visualizes the 3D data (see Chapter [3.11](#)).
 - E "3D-View" toolbar:** Use this toolbar to configure the orientation of the coordinate system and activate various options for mouse interaction in the 3D-View (see Chapter [3.11](#)).
 - F "Start measurement" button:** Click on this button to perform a measuring operation, calculate the measurement results and display the point cloud and measurement results of the currently selected measuring program in the 3D-View.
 - G Results display:** The measurement results of the currently selected measuring program are displayed. Here, you can select which measured values are to be made available later for calculation, OK/nOK assessment, logging and output (see Chapter [3.18.9](#)).
 - H Status bar:** Status and error messages are displayed in the status bar (see Chapter [8.1](#)).
-
- 1 Input data:** Use this selection field to select the input objects for the program (see also Chapter [3.18.3](#)). An overview of measuring programs, which provide points, can be found in Chapter [3.19.1](#).
 - 2 3D-View:** The 3D-View displays the input points (yellow) and the resulting plane (orange).

6.2.8 "Distance 2D" Measuring Program

Use the "Distance 2D" program to calculate the distance between two 2D objects.

Note: The "Distance 2D" measuring program is only available in the "2D" evaluation mode (see Chapter 1.4). In 3D mode, use the "Distance" program (see Chapter 6.2.1) to calculate distances between objects.

Proceed as follows:

- Select the type of distance to be calculated (see below, section "1" and Chapter 3.18.2)
- If applicable, select the input data for the program (see below, section "2" and Chapter 3.18.3). The available input data vary depending on the type of distance.
- If applicable, configure further measuring program parameters depending on the type of distance and the input data (see below, section "3").
- If applicable, select measured values that are to be used later for calculation, OK/nOK assessment, logging and output (see below, section "G" and Chapter 3.18.9).

The measuring program outputs the following measured values:

- **Euclidean distance:** The Euclidean distance between the selected objects.
- **Distance u:** The distance between the selected objects in the U direction.
- **Distance v:** The distance between the selected objects in the V direction.

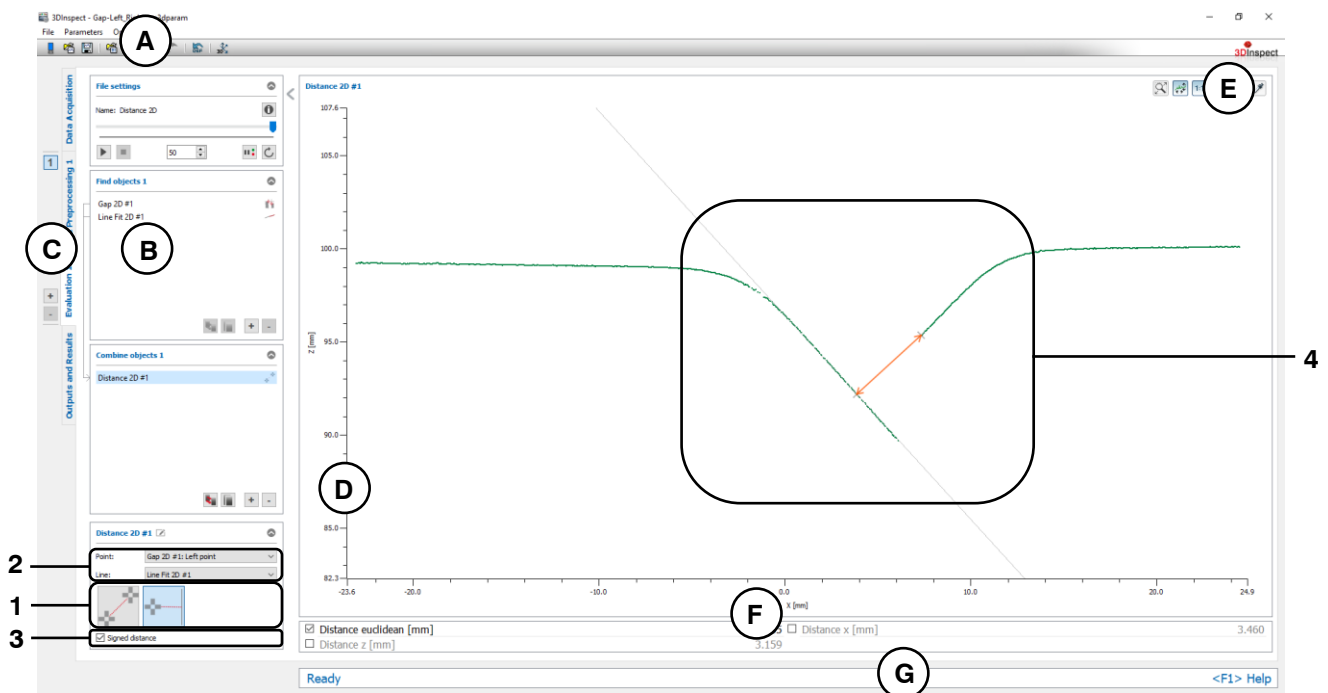

Fig. 6.37: "Distance 2D" Measuring Program

Display Elements and Parameters in the "Distance 2D" Program:

- A "General" toolbar:** Using this toolbar, you can select the data source (see Chapter 3.4 and 3.5), save and load parameters (see Chapter 3.20), reset selected parameters to default settings (see Chapter 3.20.3) and undo and restore changes of settings and parameters (see Chapter 3.21).
- B List of active measuring programs:** This section displays the active measuring programs from the "Find objects" and "Combine objects" groups. You can add and remove measuring programs/measuring program groups (see Chapter 3.15 and 3.17), move measuring programs (see Chapter 3.16) and select an active measuring program for parameterizing and displaying the measured values.
- C Measuring program groups / Tab bar for switching between views:** This tab bar allows you to switch between the four main views (see Chapter 3.2). To the left of the tab bar you find the section for adding, removing and selecting measuring program groups (see Chapter 3.17).

- D 2D Profile View:** The 2D Profile View visualizes the 2D data (see Chapter [3.13](#)).
 - E "2D Profile View" toolbar:** Use this toolbar to scale the 2D Profile View and activate various options for mouse interaction (see Chapter [3.13](#)).
 - F Results display:** The measurement results of the currently selected measuring program are displayed. Here, you can select which measured values are to be made available later for calculation, OK/nOK assessment, logging and output (see Chapter [3.18.9](#)).
 - G Status bar:** Status and error messages are displayed in the status bar (see Chapter [8.1](#)).
-
- 1 Distance type:** Select the type of distance to be calculated:
 - **Distance between two points**
 - **Distance between point and straight line**An overview of measuring programs, which provide 2D lines and 2D points, can be found in Chapter [3.19.1](#) and [3.19.2](#).
 - 2 Input data:** Use this selection field to select the input objects for the program (see also Chapter [3.18.3](#)). The available input data vary depending on the type of distance.
 - 3 Parameters:** The measuring program offers other parameters depending on the type of distance and selected input objects:
 - **Signed distance:** You can choose whether to output the signed distance or the absolute distance value. This parameter is available for the following distance types:
 - Distance between point and straight line
 - 4 2D Profile View:** The 2D Profile View shows the input profile in green, the operands (2D points and/or 2D lines) in gray. The distance between the objects is displayed as an orange arrow.

6.2.9 "Angle 2D" Measuring Program

Use the "Angle 2D" program to calculate the angle between two 2D straight lines.

Note: The "Angle 2D" measuring program is only available in the "2D" evaluation mode (see Chapter 1.4). In 3D mode, use the "Angle" program (see Chapter 6.2.2) to calculate the angle between straight lines.

Proceed as follows:

- If applicable, select the input data for the program (see below, section "1" and Chapter 3.18.3). The available input data vary depending on the type of distance.
- If applicable, configure further measuring program parameters (see below, section "2").
- If applicable, select measured values that are to be used later for calculation, OK/nOK assessment, logging and output (see below, section "G" and Chapter 3.18.9).

The measuring program outputs the following measured value:

- **Angle:** The angle between the selected 2D straight lines.

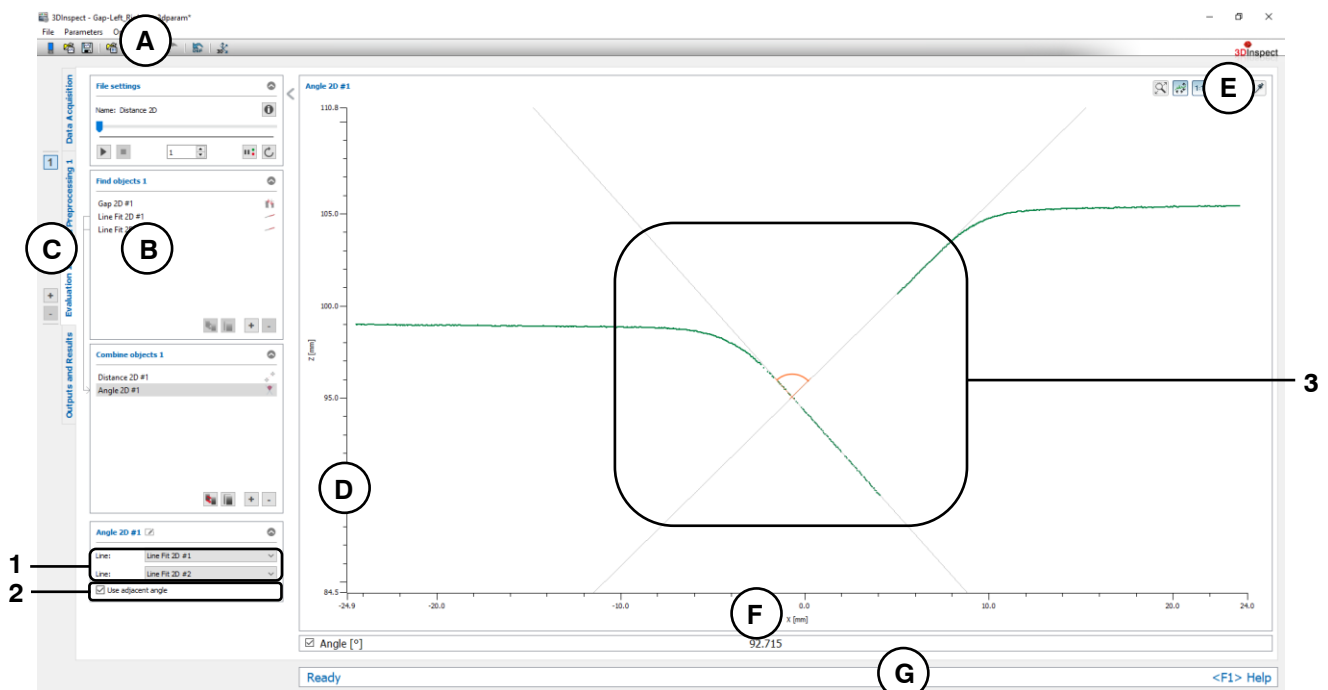

Fig. 6.38: "Angle 2D" Measuring Program

Display Elements and Parameters in the "Angle 2D" Program:

- A "General" toolbar:** Using this toolbar, you can select the data source (see Chapter 3.4 and 3.5), save and load parameters (see Chapter 3.20), reset selected parameters to default settings (see Chapter 3.20.3) and undo and restore changes of settings and parameters (see Chapter 3.21).
- B List of active measuring programs:** This section displays the active measuring programs from the "Find objects" and "Combine objects" groups. You can add and remove measuring programs/measuring program groups (see Chapter 3.15 and 3.17), move measuring programs (see Chapter 3.16) and select an active measuring program for parameterizing and displaying the measured values.
- C Measuring program groups / Tab bar for switching between views:** This tab bar allows you to switch between the four main views (see Chapter 3.2). To the left of the tab bar you find the section for adding, removing and selecting measuring program groups (see Chapter 3.17).
- D 2D Profile View:** The 2D Profile View visualizes the 2D data (see Chapter 3.13).
- E "2D Profile View" toolbar:** Use this toolbar to scale the 2D Profile View and activate various options for mouse interaction (see Chapter 3.13).

- F Results display:** The measurement results of the currently selected measuring program are displayed. Here, you can select which measured values are to be made available later for calculation, OK/nOK assessment, logging and output (see Chapter [3.18.9](#)).
- G Status bar:** Status and error messages are displayed in the status bar (see Chapter [8.1](#)).

- 1 Input data:** Use this selection field to select the input objects for the program (see also Chapter [3.18.3](#)). An overview of measuring programs which provide 2D lines can be found in Chapter [3.19.2](#).
- 2 Use adjacent angle:** Specify whether the adjacent angle should be used as the measurement result.
- 3 2D Profile View:** The 2D Profile View shows the input profile in green, the operands (2D points and/or 2D lines) in gray. The distance between the objects is displayed as an orange arrow.

6.2.10 "Object Intersection 2D" Measuring Program

Use the "Object Intersection 2D" program to calculate a new object by intersecting two 2D objects.

Note: The "Object Intersection 2D" measuring program is only available in the "2D" evaluation mode (see Chapter 1.4). In 3D mode, use the "Object Intersection" program (see Chapter 6.2.3) to intersect objects.

Proceed as follows:

- Select the type of intersection to be carried out (see below, section "1" and Chapter 3.18.2).
- If applicable, select the input data for the program (see below, section "2" and Chapter 3.18.3). The available input data vary depending on the type of intersection.
- If applicable, select measured values that are to be used later for calculation, OK/nOK assessment, logging and output (see below, section "G" and Chapter 3.18.9).

The measuring program outputs the following measured values depending on the type of intersection:

- **Calculating a point by intersecting two straight lines:**
 - **Point u:** The U coordinate of the point of intersection
 - **Point v:** The V coordinate of the point of intersection
- **Calculating two points by intersecting a straight line with a circle or by intersecting two circles:**
 - **First intersection point u:** The U coordinate of the first point of intersection
 - **First intersection point v:** The V coordinate of the first point of intersection
 - **Second intersection point u:** The U coordinate of the second point of intersection
 - **Second intersection point v:** The V coordinate of the second point of intersection

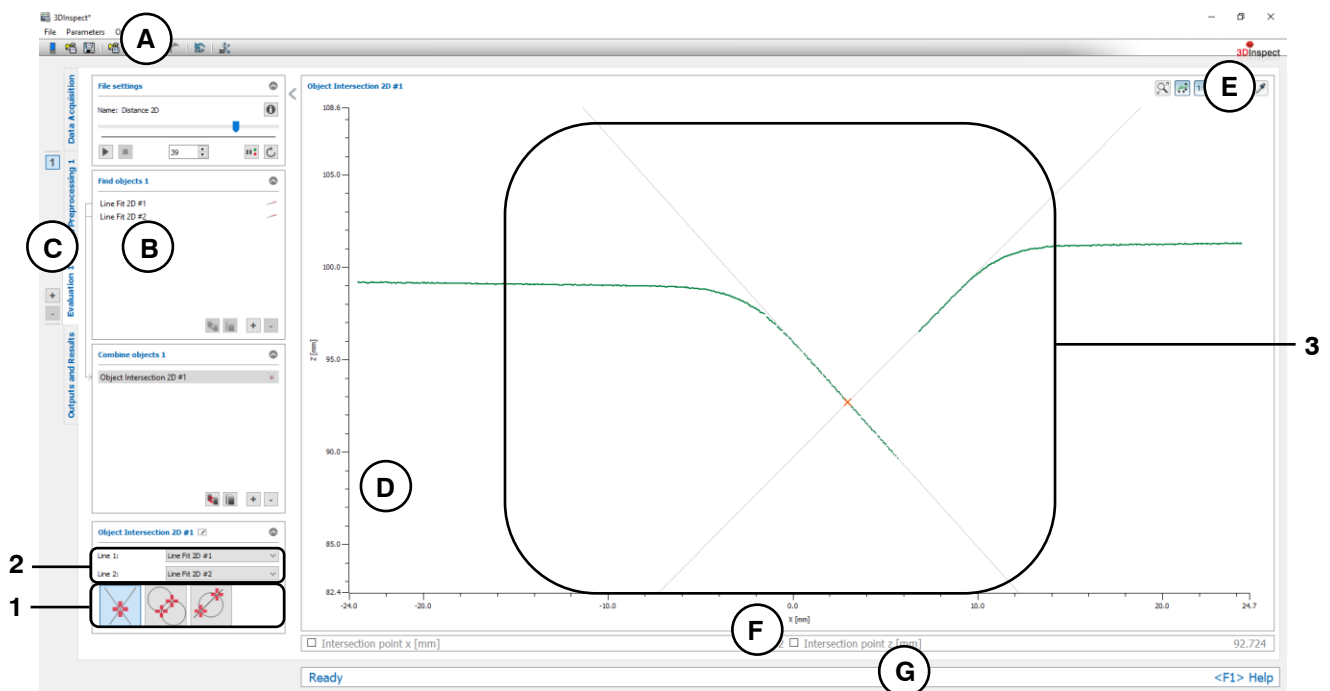

Fig. 6.39: "Object Intersection 2D" Measuring Program

Display Elements and Parameters in the "Object Intersection 2D" Program:

- A "General" toolbar:** Using this toolbar, you can select the data source (see Chapter 3.4 and 3.5), save and load parameters (see Chapter 3.20), reset selected parameters to default settings (see Chapter 3.20.3) and undo and restore changes of settings and parameters (see Chapter 3.21).
- B List of active measuring programs:** This section displays the active measuring programs from the "Find objects" and "Combine objects" groups. You can add and remove measuring programs/measuring program groups (see Chapter 3.15 and 3.17), move measuring programs (see Chapter 3.16) and select an active measuring program for parameterizing and displaying the measured values.

- C Measuring program groups / Tab bar for switching between views:** This tab bar allows you to switch between the four main views (see Chapter 3.2). To the left of the tab bar you find the section for adding, removing and selecting measuring program groups (see Chapter 3.17).
 - D 2D Profile View:** The 2D Profile View visualizes the 2D data (see Chapter 3.13).
 - E "2D Profile View" toolbar:** Use this toolbar to scale the 2D Profile View and activate various options for mouse interaction (see Chapter 3.13).
 - F Results display:** The measurement results of the currently selected measuring program are displayed. Here, you can select which measured values are to be made available later for calculation, OK/nOK assessment, logging and output (see Chapter 3.18.9).
 - G Status bar:** Status and error messages are displayed in the status bar (see Chapter 8.1).
- 1 - **Intersection type:** Select the type of intersection to be carried out:
- **Calculating a point by intersecting two straight lines**
 - **Calculating two points by intersecting two circles**
 - **Calculating two points by intersecting a straight line with a circle**
- An overview of measuring programs, which provide lines and planes, can be found in Chapter 3.19.2 and 3.19.4.
- 2 **Input data:** Use this selection field to select the input objects for the program (see also Chapter 3.18.3). The available input data vary depending on the type of intersection.
- 3 **2D Profile View:** The 2D Profile View shows the input profile in green, the operands (2D points and/or 2D circles) in gray and the intersection points in orange.

6.2.11 "Midpoint 2D" Measuring Program

Use the "Midpoint 2D" program to calculate the midpoint from two selected 2D points.

Note: The "Midpoint 2D" measuring program is only available in the "2D" evaluation mode (see Chapter 1.4). In 3D mode, use the "Midpoint" program (see Chapter 6.2.5) to calculate the midpoint from two points.

Proceed as follows:

- If applicable, select the input data for the program (see below, section "1" and Chapter 3.18.3).
- If applicable, select measured values that are to be used later for calculation, OK/nOK assessment, logging and output (see below, section "G" and Chapter 3.18.9).

The measuring program outputs the following measured values:

- **Midpoint u:** The U coordinate of the perpendicular point.
- **Midpoint v:** The V coordinate of the perpendicular point.

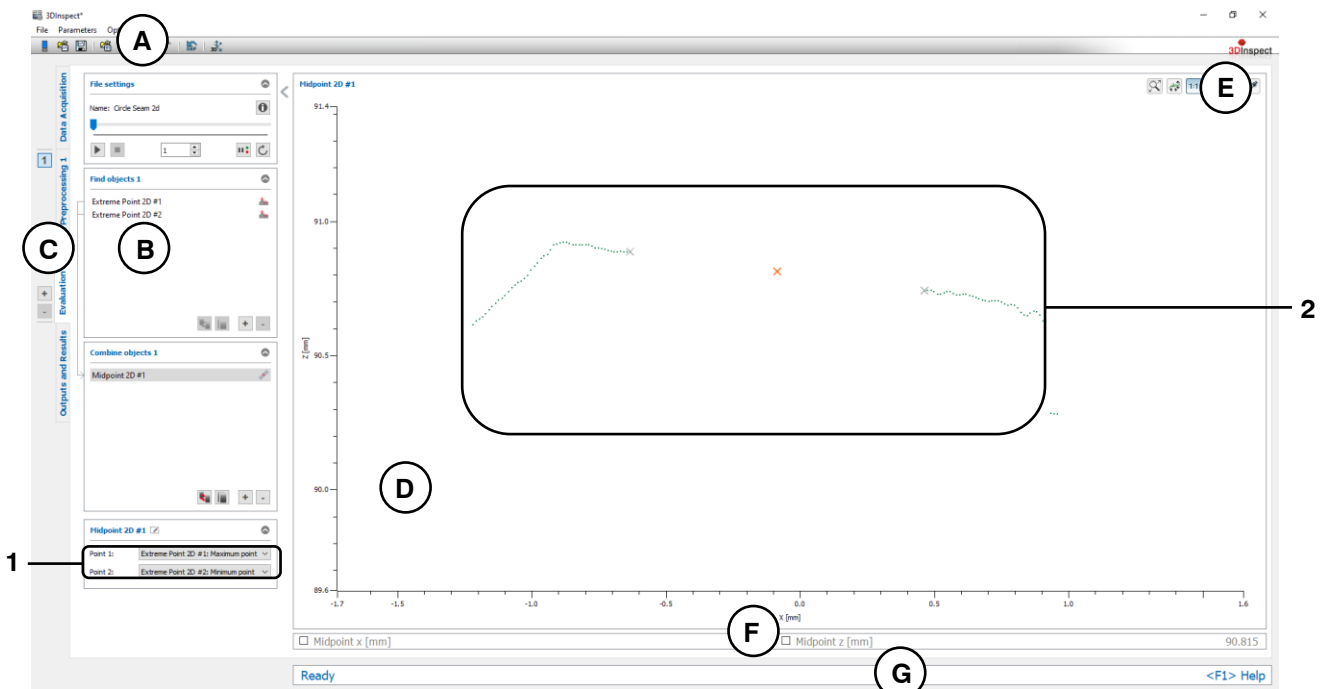

Fig. 6.40: "Midpoint 2D" Measuring Program

Display Elements and Parameters in the "Midpoint 2D" Program:

- A "General" toolbar:** Using this toolbar, you can select the data source (see Chapter 3.4 and 3.5), save and load parameters (see Chapter 3.20), reset selected parameters to default settings (see Chapter 3.20.3) and undo and restore changes of settings and parameters (see Chapter 3.21).
- B List of active measuring programs:** This section displays the active measuring programs from the "Find objects" and "Combine objects" groups. You can add and remove measuring programs/measuring program groups (see Chapter 3.15 and 3.17), move measuring programs (see Chapter 3.16) and select an active measuring program for parameterizing and displaying the measured values.
- C Measuring program groups / Tab bar for switching between views:** This tab bar allows you to switch between the four main views (see Chapter 3.2). To the left of the tab bar you find the section for adding, removing and selecting measuring program groups (see Chapter 3.17).
- D 2D Profile View:** The 2D Profile View visualizes the 2D data (see Chapter 3.13).
- E "2D Profile View" toolbar:** Use this toolbar to scale the 2D Profile View and activate various options for mouse interaction (see Chapter 3.13).

- F Results display:** The measurement results of the currently selected measuring program are displayed. Here, you can select which measured values are to be made available later for calculation, OK/nOK assessment, logging and output (see Chapter [3.18.9](#)).
- G Status bar:** Status and error messages are displayed in the status bar (see Chapter [8.1](#)).

- 1 Input data:** Use this selection field to select the input objects for the program (see also Chapter [3.18.3](#)). An overview of measuring programs, which provide 2D points, can be found in Chapter [3.19.1](#).
- 2 2D Profile View:** The 2D Profile View shows the input profile in green, the operands (2D points) in gray and the mid point in orange.

7. Description of the "Outputs and Results" View

Use the "Results" view or, as the case may be, the "Outputs and Results" view to calculate (see Chapter 7.2) and assess (see Chapter 7.3) measured values and to configure these for outputting and logging (see Chapter 7.4). Additionally, you can set the parameters for the software operating mode (see below, section "2" and Chapter 1.4).

Note: If you are using the "Automation" function extension (see Chapter 1.2), this view is labeled with "Outputs and Results", otherwise it is labeled with "Results".

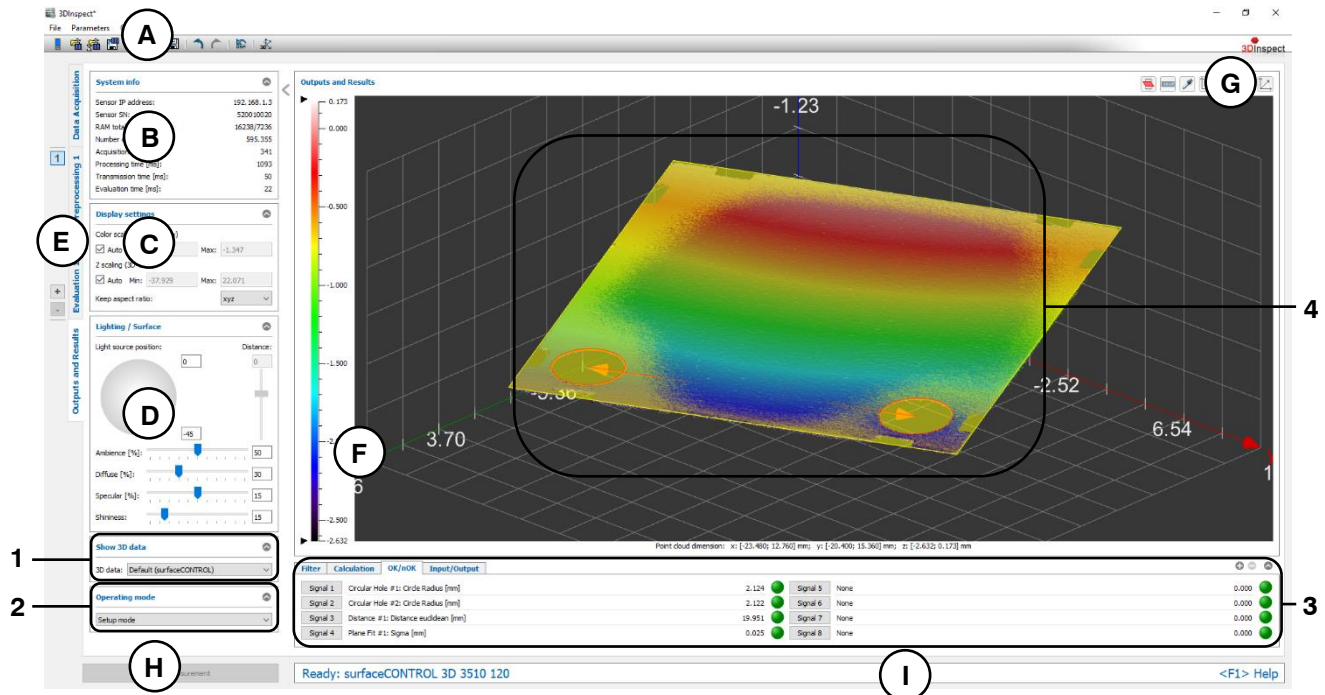

Fig. 7.1: "Results" / "Outputs and Results" view

Display Elements and Parameters in the "Outputs and Results" View:

- A "General" toolbar:** Using this toolbar, you can select the data source (see Chapter 3.4 and 3.5), save and load parameters (see Chapter 3.20), reset selected parameters to default settings (see Chapter 3.20.3) and undo and restore changes of settings and parameters (see Chapter 3.21).
- B Status display:** The status display shows current sensor information and the last measurement that was carried out (see Chapter 3.7).
- C Display settings:** Use this section to specify settings for the 2D- and 3D-View (see Chapter 3.8).
- D Lighting/Surface:** Use this input field to set the lighting and surface properties of the 3D data (see Chapter 3.10).
- E Tab bar for switching between views:** This tab bar allows you to switch between the four main views (see Chapter 3.2).
- F 3D-View:** The 3D-View visualizes the 3D data (see Chapter 3.11).
- G "3D-View" toolbar:** Use this toolbar to configure the orientation of the coordinate system, get point information or measure distances in the 3D-View (see Chapter 3.11).
- H "Start measurement" button:** Click on this button to perform a measuring operation, calculate the measurement results and display the point cloud and the measurement results.
- I Status bar:** Status and error messages are displayed in the status bar (see Chapter 8.1).

- 1 **3D data:** Use this field to select the point cloud to be displayed in the 3D-View. The results data of the measuring programs in the "Data preprocessing" group and the originally measured point cloud of the connected sensor or from a loaded file can be used.
- 2 **Operating mode:** You can use this selection field to set the software operating mode (see also Chapter 1.4):
 - **Setup mode:** Use setup mode to set the parameters for your measuring task. You can carry out measuring operations using the "Start measurement" button (see above, section "H").
 - **Measurement mode:** Use the measurement mode to automatically perform measurements. You may setup the settings for the measurement control in the "Measurement control / Measured values output" dialog (see Chapter 7.4). The "Start measurement" button (see above, section "H") is not available in measurement mode.

Note: The input field "Operating mode" is only available in online mode (see Chapter 3.4). Setup mode is automatically activated in offline mode (see Chapter 3.5).

Note: The "Measurement mode" is only available if you use the "Automation" function extension (see Chapter 1.2).

- 3 **Filter, Calculation, OK/nOK, Input/Output:** With these tabs, you can apply settings for filtering measured values (see Chapter 7.1), calculating measured values (see Chapter 7.2), assessing measured values (see Chapter 7.3) and for outputting and logging measured values (see Chapter 7.4) as well as for controlling the measurement (see Chapter 7.4).
- 4 **3D-View:** The 3D-View displays the objects associated with the measured values chosen for the calculation, assessment and outputting/logging.

7.1 Configuration of the Filters for Measured Values

3DInspect provides the possibility to filter measured values chronologically. To do so, select the "Filter" tab. The measured values from the measuring programs that you marked for output (see Chapter 3.18.9) and already filtered values are available. Use the "+" or "-" buttons to increase or decrease the number of filtered values.

Filter	Calculation	OK/nOK	Input/Output			
Filter 1	Circle Fit 2D #1: Circle Radius (avg_3) [mm]		13.141	Filter 5	None	0.000
Filter 2	None		0.000	Filter 6	None	0.000
Filter 3	None		0.000	Filter 7	None	0.000
Filter 4	None		0.000	Filter 8	None	0.000

Fig. 7.2: "Filter" tab

The current filtered values are listed in the "Filter" tab. Press the "Filter x" button to configure the respective filter. The following dialog box will be displayed:

Fig. 7.3: "Filter settings" dialog

Make the following settings:

- **Value x:** Select the measured value to be filtered.
- **Filter type:**
 - **average:** Activate an average filter with this parameter.
 - **delay:** This parameter activates the delayed output of a measured value. It is possible to delay the output of a measured value by up to 1023 measurement operations.
 - **median:** Activate a median filter with this parameter.
 - **minumum:** Activate a minimum filter with this parameter.
 - **maximum:** Activate a maximum filter with this parameter.
- **Filter size [tap]:** Enter the filter size (maximum value 10000).

Confirm your settings with the "OK" button.

The filtered measurement values are labeled as follows: The filter type (avg, del, med, min or max) and filter size are added to the name of the filtered measurement in curved brackets. For example, (med_3) stands for a filtered value with a median filter of size 3.

7.2 Calculating Measured Values

3DInspect gives you the option of calculating measured values with one another. To do this, activate the "Calculation" tab. The measured values from the measuring programs that you marked for output (see Chapter 3.18.9), the filtered measured values (see Chapter 7.1), the already calculated measured values and user-defined constants can be used. Use the "+" or "-" buttons to increase or decrease the number of calculated values.

Filter	Calculation	OK/nOK	Input/Output			
	Calculation 1	Radius difference front [mm]	0.003	Calculation 5	None	0.000
	Calculation 2	None	0.000	Calculation 6	None	0.000
	Calculation 3	None	0.000	Calculation 7	None	0.000
	Calculation 4	None	0.000	Calculation 8	None	0.000

Fig. 7.4: "Calculation" tab

The "Calculation" tab displays the currently calculated values. Click on the "Calculation X" button to configure the relevant calculated value. The following dialog is displayed:

Fig. 7.5: "Calculation settings" dialog

The following settings are available:

- **Signal x:** Enter a name for the calculated signal.
- **Operands:** The following settings are available for the individual operands:
 - **Operator:** If required, use a unary operator. The following operators are available:
 - Square
 - Square root
 - Sine
 - Cosine
 - Tangent
 - Absolute value
 - Negation
 - **Value i:** Select the measured value to be used as the operand.
 - **Link operator:** If required, use a binary operator in order to use another measured value for the calculation. You can calculate up to eight measured values. The following operators are available:
 - Addition
 - Subtraction
 - Multiplication
 - Division

Note: The device temperature is only available for surfaceCONTROL and scanCONTROL sensors.

The resulting equation and the result of the current calculation are displayed in the bottom region of the dialog.

7.3 Assessing Measured Values (OK/nOK)

3DInspect gives you the option of generating logic signals for assessing measured values (OK/nOK). Activate the "OK/nOK" tab for the configuration. The measured values from the measuring programs that you marked for output (see Chapter 3.18.9), the filtered values (see Chapter 7.1) and the calculated values (see Chapter 7.2) can be used. Use the "+" or "-" buttons to increase or decrease the number of assessed values.

Filter	Calculation	OK/nOK	Input/Output
Signal 1	Circular Hole #1: Circle Radius [mm]	2.127	Signal 5: None
Signal 2	Circular Hole #2: Circle Radius [mm]	2.124	Signal 6: None
Signal 3	None	0.000	Signal 7: None
Signal 4	None	0.000	Signal 8: None

Fig. 7.6: "OK/nOK" tab

The "OK/nOK" tab displays the currently assessed measured values. Click on the "Signal X" button to configure the relevant assessment. The following dialog is displayed:

Fig. 7.7: "OK/nOK settings" dialog

The following settings are available:

- **Signal X:** Enter a name for the evaluated signal.
- **Value N:** Select a measured value to be evaluated.
 - **Min:** The lower limit of the range for assessing the selected measured value.
 - **Max:** The upper limit of the range for assessing the selected measured value.
 - **Invert:** Depending on the parameter setting, the assessment is performed as follows:
 - **Not active:** If the relevant signal lies within the specified range, the value is deemed OK, otherwise it is deemed nOK. If the measured value is equal to the range limits, it is also deemed OK. If an error occurs during determination of the measured value, the value is deemed nOK.
 - **Active:** If the relevant signal lies within the specified range, the value is deemed nOK, otherwise it is deemed OK. If the measured value is equal to the range limits, it is also deemed nOK. If an error occurs during determination of the measured value, the value is deemed OK.
 - **Logical link:** Specify whether the current result of the evaluation should be logically linked to another signal. You can logically link up to eight signals. The following algorithms are available:
 - **AND:** Logical AND link.
 - **OR:** Logical OR link.
 - **XOR:** Logical XOR link.

Note: When outputting and logging measured values, the following numerical assignment applies: OK = 1, nOK = 0.

Note: The device temperature is only available for surfaceCONTROL and scanCONTROL sensors.

7.4 Outputting and Logging Measured Values, Controlling the Measurement

3DInspect gives you the option of outputting measurement results using various protocols via Ethernet and logging the measurement results in a file. Activate the "Input/Output" tab for the configuration. The measured values from the measuring programs that you marked for output (see Chapter 3.18.9), the device temperature of the sensor, the part number, the filtered values (see Chapter 7.1), the calculated values (see Chapter 7.2) and the assessed values (see Chapter 7.3) can be used.

Two options are available for the generation of the part number which can be used for assigning the measured parts:

- **Manual input:** For each measuring operation a dialog for entering the part number will be shown (see also Chap 3.25, Section 3).
- **Transfer via the automation interface:** If the measurement is controlled via Modbus TCP, Ethernet/IP, Profinet or EtherCAT, you have the option of transferring the part number by the control unit (see also Chap 3.23, "Documentation" menu).

Note: Outputting measured values and logging in online mode are only available if you are using the "Automation" function extension (see Chapter 1.2).

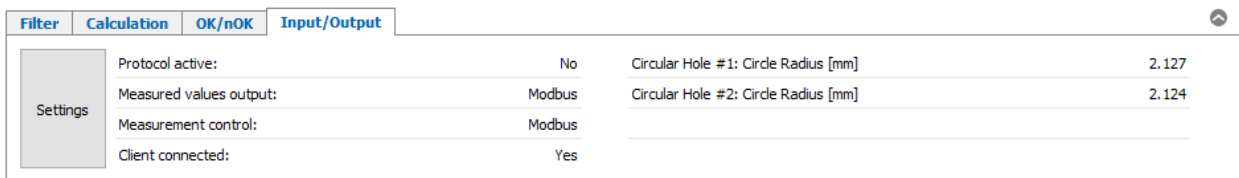

Fig. 7.8: "Input/Output" tab

The "Input/Output" tab displays the logging configuration, the settings for outputting the measured values and the selected measured values. Click on the "Settings" button to configure the settings for logging and for outputting the measured values. The following dialog is displayed:

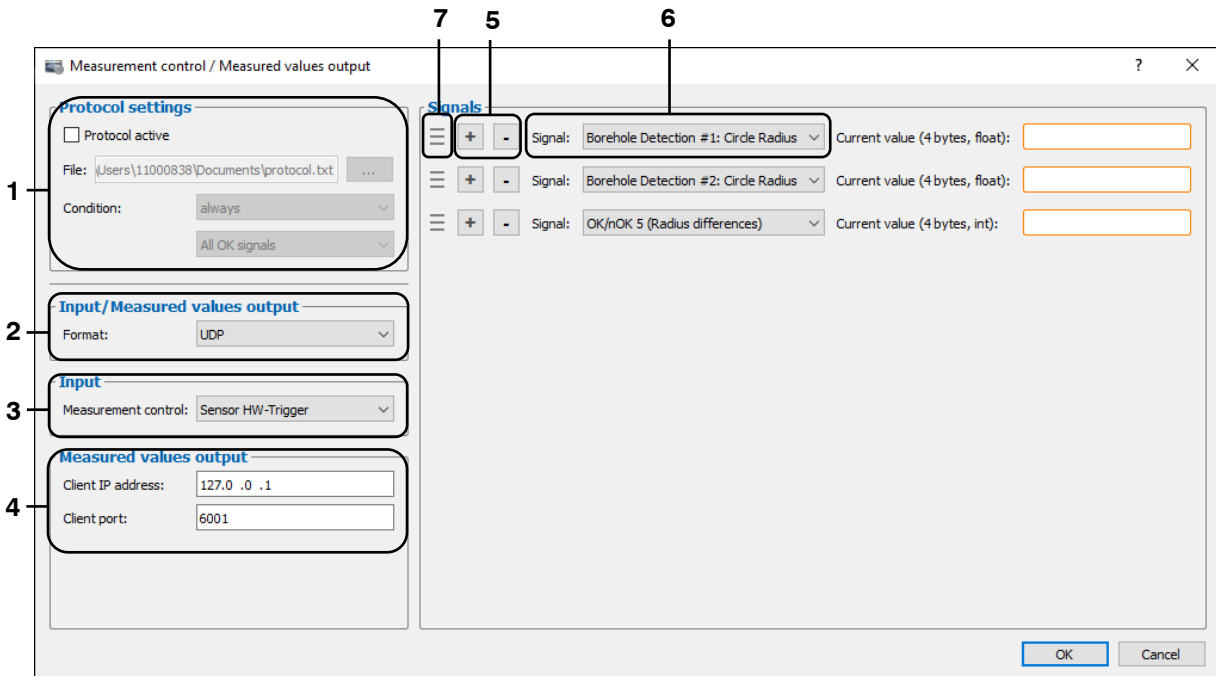

Fig. 7.9: "Measurement control / Measured values output" dialog

The following settings are available:

1 Protocol settings:

- **Protocol active:** You can use this parameter to activate or deactivate logging of measured values in a file.
- **File:** Here you can edit the complete path of the log file where the measured values should be saved. As standard, the file name has the extension ".txt". Use the button "..." in order to select the file using a standard Windows dialog.
- **Condition:** Use this parameter to define the logging condition (see Chapter 7.3):
 - **Always:** All measuring operations are logged.
 - **nOK:**
 - **All nOK signals:** Measuring operations in which all assessed measured values are deemed nOK are logged.
 - **Any nOK signal:** Measuring operations in which at least one assessed measured value is deemed nOK are logged.
 - **nOK x:** Measuring operations in which the assessed measured value x is deemed nOK are logged.
 - **OK:**
 - **All OK signals:** Measuring operations in which all assessed measured values are deemed OK are logged.
 - **Any OK signal:** Measuring operations in which at least one assessed measured value is deemed OK are logged.
 - **OK x:** Measuring operations in which the assessed measured value x is deemed OK are logged.

2 Input/ Measured values output

- **Format:** Select the protocol for outputting the measured values via Ethernet. The following options are available:
 - **None:** The measured value output function is not active.
 - **UDP:** The measured values are output via UDP. 3DInspect acts as a UDP server.
 - **TCP:** The measured values are output via TCP. 3DInspect acts as a TCP server.
 - **Modbus:** The measured values are output via Modbus TCP. 3DInspect acts as a Modbus TCP server.
 - **EtherNet/IP:** The measured values are output via EtherNet/IP. 3DInspect acts as an EtherNet/IP adapter.
 - **Profinet:** The measured values are output via Profinet. 3DInspect acts as a Profinet IO device.
 - **EtherCAT:** The measured values are output via EtherCAT. 3DInspect acts as an EtherCAT Slave.
- **Mode:** If you use Modbus, Ethernet/IP, Profinet or EtherCAT, you define the mode for the measurement control with this parameter (sequential, parallel or continuous (2D) processing of data acquisition and measurement evaluation).
- **Byte order:** If you use Ethernet/IP, Profinet or EtherCAT, you define the byte order of the fieldbus registers with this parameter (Big-Endian/Little-Endian)

Note: The Modbus, EtherNet/IP, Profinet and EtherCAT protocols are referred to fieldbus protocols in the following.

Note: The measured values are transmitted in binary form. Whole numbers are transmitted as integers (4 bytes) and floating-point numbers are transmitted as floats (4 bytes).

Note: When using a fieldbus protocol up to 114 fieldbus registers (16 bits each) can be used. The output of measured values starts at Register 11. A measured value requires 32 bits, i.e. two registers. The upper 16 bits are stored in the first and the lower 16 bits are stored in the second register.

Note: A special hardware extension is necessary for using the EtherNet/IP, Profinet or EtherCAT protocol. Please refer to the contact address printed on the inside cover.

Note: If you are using Modbus TCP and a firewall is installed on the system, you have to open the TCP Port 502 in the firewall configuration.

3 Input:

- **Measurement control:** Here you can configure the way in which the measurement is controlled:
 - **Sensor HW-Trigger:** The measurement is controlled via the sensors hardware trigger input.
 - **Modbus:** The measurement is controlled via Modbus TCP.
 - **EtherNet/IP:** The measurement is controlled via EtherNet/IP.
 - **Profinet:** The measurement is controlled via Profinet.
 - **EtherCAT:** The measurement is controlled via EtherCAT.
- **Parameter file mapping...:** If you are using a fieldbus protocol for the measurement control, you have the option for loading parameter files via the automation interface. Press this button in order to configure the parameter file list. (see Chapter [7.4.1](#)).

Note: The measurement control is only available if you are using the "Automation" function extension (see Chapter [1.2](#)).

Note: A detailed description of the measurement control sequence can be found in the respective documentation (see Chapter [3.23](#), "Documentation" menu).

Note: The "Sensor HW-Trigger" option is not available for reflectCONTROL sensors.

4 Measured values output: Here you can configure the parameters for outputting the measured values. Depending on the selected output protocol (see above, section "2"), the following options are available:

- **UDP:**
 - **Client IP address:** The IP address of the recipient
 - **Client port:** The UDP port of the recipient
- **TCP:**
 - **Server port:** The TCP port via which the software accepts incoming connections.

Note: 3DInspect uses source port 8000 for the UDP connection.

- 5** - Inserting/deleting a signal:
- Click on this button to add a measured value to be output and/or logged.
 - Click this button to deactivate the measured value output and/or logging function.
- 6** - Select the measured value to be output and/or logged.
- 7** - Change the sequence of measured values by using "Drag & Drop". To do so, click the grab area and drag the cursor to the desired location. The measured value is moved to the desired location.
-  Confirm the dialog with the "OK" button to apply the settings.

7.4.1 Load parameters in an Automated Manner

If you are using a fieldbus protocol for the measurement control you have the option of loading parameter files via the automation interface. Thus you have the possibility of switching between measurement settings and measurement object types in the automation process. You may setup a list of up to 255 parameter files which can be loaded using the corresponding index (1 - 255) in the automation interface (see also Chapter 3.23, "Documentation" menu). In the "Parameter file mapping" dialog you have the possibility to setup the mapping of previously saved parameter files and indices.

- ➔ Press the "Parameter file mapping..." button in the "Measurement control / Measured values output" dialog (see Chapter 7.4, Section 3) in order to access the "Parameter file mapping" dialog.

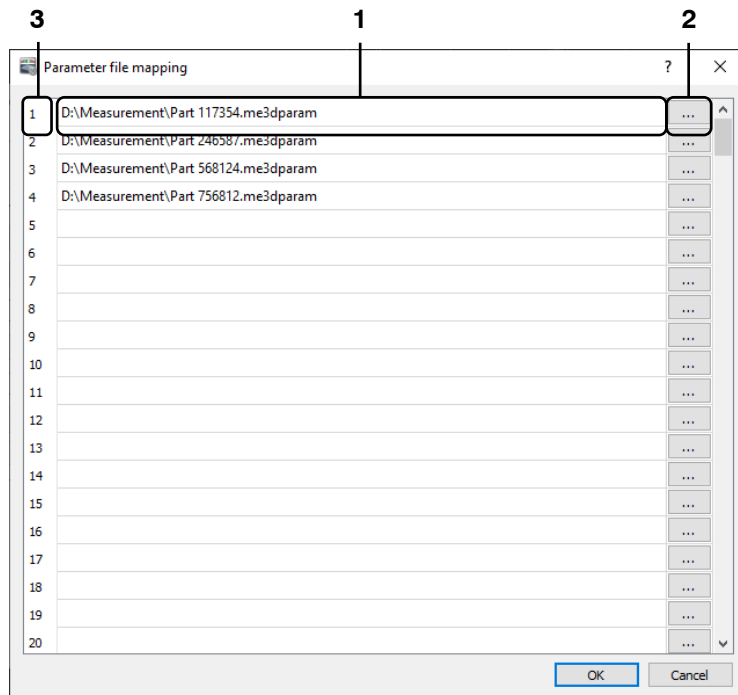

Fig. 7.10: "Parameter file mapping" dialog

The following settings are available:

- 1 For each index the currently assigned parameter file is displayed. You may directly edit the desired file name in this section.
- 2 Use this button in order to open a standard Windows dialog for selecting a parameter file for the respective index.
- 3 Each line defines an index for assigning a parameter file. You may use this section for shifting already existing assignments. In order to do so, press and hold down the left mouse button on the index to be shifted, move the mouse to the desired target index and release the mouse button.

- ➔ Confirm the dialog with the "OK" button to apply the settings.

8. Appendix

8.1 Status and Error Messages

Various status and error messages are displayed in the status bar of the individual measuring programs. If an error is caused by a measuring program, you can directly access the affected measuring program by clicking on the underlined program name in the status bar. The following messages can appear:

Message	Description	Action
Ready: [Sensor type]	No error. The sensor is ready to perform measurements.	Click on the "Start measurement" button (setup mode) or trigger the sensor (measurement mode) in order to perform a measurement.
Ready: [Sensor type] – No network license	No error, but there is no network license present. You can use the functions of the software and the sensor for 15 minutes. After that the transmitted sensor data is invalid.	To acquire a network license please refer to the contact address printed on the inside cover for further information.
Measuring [Sensor type]	The sensor is collecting measurement data. The sensor and/or the object being measured must not be moved during this time.	-
Data processing [Sensor type]	The sensor is calculating a 3D point cloud from the raw data acquired.	The sensor can be moved to the next measuring position and/or the next component can be placed in the measuring position.
Rendering 3D-View	The sensor has calculated the 3D point cloud. The point cloud is transmitted to the software and displayed in the 3D-View.	-
Computing measured values	The measured values from the measuring programs are being calculated.	-
Active: [Sensor type]	No error. You are in the "Image data" view. The raw data from the sensor are being transmitted continuously.	
Disconnected	No sensor is connected.	Use the menu item "File → Connect to sensor" or the corresponding button (see Chapter 3.4) to establish the connection to a sensor.
Connecting to sensor...	The connection to the sensor is being established.	-
Waiting for part number	The "Enter part number manually" option is active (see Chapter 3.25, section 3). 3DInspects waits until the part number for the current measurement is entered.	Enter the part number in the input dialog and press OK.
Error initializing 3D-Sensor SDK	The 3D sensor SDK required for sensor communication and the underlying eBus SDK could not be initialized.	Re-install the software.
Error finding sensors	The search for sensors in the network has failed.	Check whether the Ethernet interface has been installed correctly and is available in the operating system.

No sensor found	No sensor is connected to the PC or the sensor power supply is switched off.	Check the Ethernet connection and check whether the sensor is being supplied with power. Check the Ethernet cable for defects.
Error connecting to sensor	The IP configuration of the sensor is incorrect.	Use the menu item "Options → Ethernet configurator" to set up the sensor with a valid IP configuration (see Chapter 3.26).
Sensor version mismatch	The firmware version of the sensor is not compatible with the version of 3DInspect used.	Install the latest version of 3DInspect.
Sensor is already in use	The currently used sensor is already being used by other programs.	Close the program that is accessing the sensor or use the menu item "File → Connect to sensor" or the corresponding button (see Chapter 3.4) to establish the connection to another sensor.
Data transfer interrupted	The data transfer between the sensor and the PC was interrupted.	Check the Ethernet connection between the PC and sensor. Check the Ethernet cable for defects. Close the software, reconnect the sensor to the PC and restart the software.
Error data transfer	The data transmitted by the sensor are incorrect.	Check the Ethernet connection between the PC and sensor. Check the Ethernet cable for defects. Check whether the jumbo frames are active in the Ethernet interface used and the largest possible value is being used.
A measurement is already in progress	An attempt was made to start a measuring operation even though the last measuring operation has not finished.	Wait until the current measuring operation has finished.
No points in 3D-View	There are no points in the 3D-View.	Check whether the object being measured is within the current measuring range. Correct the settings for the measuring range (see Chapter 3.4.6). Correct the sensor parameters (see Chapter 3.4.1, 3.4.3 and 3.4.4)
No 3d points detected	The raw data contain no valid information regarding the calculation of the 3D reconstruction.	Check whether the exposure time is long enough and whether the amplitude threshold is not too high. Check whether the object being measured is within the measuring range of the sensor. If necessary, reset the parameters to default.
Resampling of 3D result not successful	The parameters for the 3D resampling are invalid.	Correct the settings for the resolution and measuring range (see Chapter 3.4.6).
Sensor hardware error	An error occurred in a hardware component in the sensor.	Contact Micro-Epsilon.
Sensor data acquisition error	An error occurred during data acquisition in the sensor.	Contact Micro-Epsilon.
Invalid referencing target file	The referencing target file is invalid (reflectCONTROL).	Check if you have used the correct referencing target file.

Could not apply reference measurement	The reference measurement is invalid or does not exist (reflectCONTROL).	Perform a reference measurement and ensure that the value of the "Binning" parameter matches the value used in the reference measurement.
3D filter operation not successful	An internal error occurred when the filter operations were applied (reflectCONTROL).	Contact Micro-Epsilon.
Reference measurement not successful	An error occurred when the reference measurement was performed (reflectCONTROL).	First, perform a normal measurement and check the error. Fix the error and then perform a reference measurement.
Device temperature is becoming critical	The sensor temperature is very high	Wait some time before you start the next measurement. Decrease the ambient temperature.
Device temperature is critical - Measurements are disabled	The sensor temperature is too high for performing measurements	Wait some time before you start the next measurement. Decrease the ambient temperature.
Unknown sensor warning	An unknown warning has occurred in the sensor.	Contact Micro-Epsilon.
Unknown sensor error	An unknown error has occurred in the sensor.	Contact Micro-Epsilon.
Error loading parameter file	An error has occurred while loading a parameter file.	Check if 3d parameter file is valid.
Sensor parameters invalid	The parameters which are provided by the sensor are insufficient.	Contact Micro-Epsilon.
Couldn't open file	An error has occurred while loading a point cloud file.	Check if the point cloud file is valid.
[Measuring program name]: Missing input data configuration	The input data have not been configured in the measuring program specified.	Configure the input data of the measuring program (see Chapter 3.18.3)
[Measuring program name]: Unknown measuring program state	An unknown error has occurred in the measuring program specified.	Contact Micro-Epsilon.
[Measuring program name]: Unspecified error	An unspecified error has occurred in the measuring program specified.	Contact Micro-Epsilon.
[Measuring program name]: No input points	The input point cloud of the specified measuring program contains no points.	Check the parameters of the measuring program generating the point cloud.
[Measuring program name]: No ROI is defined	The specified measuring program requires at least one ROI in order to run properly.	Set the parameters for the ROI in the measuring program specified (see Chapter 3.18.4).
[Measuring program name]: Invalid input object	The input object of the specified measuring program is invalid.	Check the parameters of the measuring program generating the input object.
[Measuring program name]: Inconsistent number of objects	The number of input objects for the specified measuring program is inconsistent.	Contact Micro-Epsilon.
[Measuring program name]: No points in region of interest	There are no measuring points in the ROI of the measuring program specified.	Enlarge the ROI (see Chapter 3.18.4). Check whether the object being measured is within the current measuring range. Correct the settings for the measuring range (see Chapter 3.4.6). Correct the sensor parameters (see Chapter 3.4.1, 3.4.3 and 3.4.4).

[Measuring program name]: Too few points in region of interest	There are not enough points in the ROI of the specified measuring program for calculating the measured values.	Enlarge the ROI (see Chapter 3.18.4). Check whether the object being measured is within the current measuring range. Correct the settings for the measuring range (see Chapter 3.4.5). Correct the sensor parameters (see Chapter 3.4.1, 3.4.3 and 3.4.4).
[Measuring program name]: Too few points are detected	Not enough points were detected in the specified measuring program for calculating the measured values	Check the parameters of the measuring program specified.
[Measuring program name]: The object can't be fitted (Points are too close to each other)	The target object could not be calculated in the measuring program specified, as the selected points in the measuring program are too close together.	Enlarge the ROI (see Chapter 3.18.4). Check the parameters of the measuring program specified.
[Measuring program name]: The object can't be fitted (Collinear points)	The target object could not be calculated in the measuring program specified, as the selected points in the measuring program are collinear.	Enlarge the ROI (see Chapter 3.18.4). Check the parameters of the measuring program specified.
[Measuring program name]: The object can't be fitted (Optimized fitting failed)	The target object could not be calculated in the measuring program specified, as the optimized fit has failed.	Check the threshold for the optimized fit in the measuring program specified or deactivate optimized fit.
[Measuring program name]: The object can't be fitted (max iteration achieved)	The target object could not be calculated in the measuring program specified, as the maximum number of iterations has been reached.	Check the parameters of the measuring program specified.
[Measuring program name]: The object can't be fitted	The target object could not be calculated in the measuring program specified.	Enlarge the ROI (see Chapter 3.18.4). Check the parameters of the measuring program specified.
[Measuring program name]: Input object isn't supported	The specified measuring program does not support the type of input object selected.	Check the configuration of the measuring program input data (see Chapter 3.18.3).
[Measuring program name]: Input objects aren't supported in this combination	The specified measuring program does not support the combination of input objects selected.	Check the configuration of the measuring program input data (see Chapter 3.18.3).
[Measuring program name]: Intersecting objects	The distance between two objects can't be computed because the objects are intersecting.	Deactivate the "Distance to surface" option (see Chapter 6.2.1).
[Measuring program name]: Reference plane doesn't intersect given ROI	The specified measuring program could not determine the measured values correctly, as the reference plane does not intersect the ROI specified in the measuring program.	Enlarge the ROI (see Chapter 3.18.4) in the measuring program specified or check the parameters of the measuring program generating the reference plane (see Chapter 6.1.3).
[Measuring program name]: Structured point cloud is required	Internal error.	Contact Micro-Epsilon.
[Measuring program name]: Mesh information is required	Internal error.	Contact Micro-Epsilon.

[Measuring program name]: Structured point cloud or mesh information are required	Internal error.	Contact Micro-Epsilon.
[Measuring program name]: Invalid port index	Internal error.	Contact Micro-Epsilon.
Input/output: Error measured values output	An error occurred during output of the measured values via Ethernet.	Check the Ethernet connection and Ethernet interface used for outputting the measured values. Check the settings for the output of measured values (see Chapter 7.4).
Input/output: Error input/output interface	An error occurred during initialization of the Ethernet interface for outputting the measured values.	Check the Ethernet interface used for outputting the measured values. Check the settings for the output of measured values (see Chapter 7.4).
[Measuring program name]: Point cloud with equidistant grid is required	The measuring program requires an equidistant grid but the input point cloud has no equidistant grid.	Use the "Resample" program (see Chapter 5.1.8) in order to create a point cloud with an equidistant grid.
[Measuring program name]: "Filter kernel size too big	The size of the kernel in the specified measuring program is too big.	Reduce the kernel size or use the "Resample" program (see Chapter 5.1.8) in order to reduce the point count.
[Measuring program name]: ROI type is not supported	Internal error.	Contact Micro-Epsilon.
Resample: The resulting grid of the point cloud is too big	The resulting grid of the resampled point cloud is too large.	Reduce the resolution or reduce the resampling range.
Index for accessing vector element is invalid	Internal error.	Contact Micro-Epsilon.
Index for accessing scalar value is invalid	Internal error.	Contact Micro-Epsilon.
Invalid Fieldbus state (Write results)	An unexpected state has occurred while the measurement has been controlled via fieldbus.	Check the implementation of the state machine for measurement control in your control system.
Invalid Fieldbus state (Trigger measurement)		
Error trigger measurement (Fieldbus)		
Fieldbus Holding Registers: Unexpected Q_Start bit = 1		
Invalid Fieldbus state (Acknowledge results)		
Fieldbus Holding Registers: Unexpected Q_ResultsAck bit = 1		
Invalid Fieldbus state (Load parameters)		
Too much Fieldbus Input registers	The number of the selected signals for outputting the measured values is too high.	Reduce the number of selected signals in the settings for the output of measured values (see Chapter 7.4).
Unsupported data type for Fieldbus result	Internal error.	Contact Micro-Epsilon.
Fieldbus: Error loading parameters	The parameters which have been requested via fieldbus couldn't be loaded.	Check the parameter mapping (see Chapter 7.4.1)
Error input/output interface	The communication via UDP or TCP couldn't be initialized.	Check the settings for the output of measured values via UDP or TCP (see Chapter 7.4)

Modbus: Error creating socket	The access to the TCP port 502 which is necessary for Modbus has failed.	Check if the TCP Port 502 is open in your firewall configuration. Check if another application is using the TCP port 502.
Input/Output: Couldn't load library	The library which is necessary for controlling the measurement via fieldbus couldn't be found.	Contact Micro-Epsilon.
Input/Output: Error fieldbus startup	The fieldbus couldn't be initialized for controlling the measurement or for the output of measured values.	Check the correspondent settings in your control system.
Input/Output: Error fieldbus communication	An error has occurred in the fieldbus communication for controlling the measurement or for the output of measured values.	Check the correspondent settings in your control system.
Waiting for acknowledged measured results	A new measurement has been triggered via Fieldbus but the measured results of the current measurement hasn't been acknowledged yet.	Check the processing logic in your control system.
Ready	No error. A point cloud was loaded (offline mode).	-
The file [...] could not be opened!	The specified name or path of the point cloud is incorrect.	Select the correct directory containing your captured point cloud.

8.2 Notes and Tips on Using 3DInspect

Please note the following when operating 3DInspect:

- 1 Never change the settings of the Ethernet interface used when the software is running. This may cause the operating system to shut down unintentionally.
- 2 Never disconnect the connection between the sensor and the PC while using the software. Never disconnect the power supply of the sensor while the software is running.
This may cause the software to shut down unintentionally.
- 3 In order to be able to activate the "Automation" function extension of 3DInspect, you will need the surfaceCONTROL 3D 3X10-XX sensor.
- 4 If you accidentally start a new ROI while defining another when using the mouse in the 3D-View, you can undo this using the Escape key.
- 5 If "Setting region of interest" mode is active in the 3D-View, you can rotate and move the 3D-View using the right mouse button (see Chapter 3.11).
- 6 When setting ROIs in the 3D-View (see Chapter 3.18.4), it is often helpful to deactivate the perspective 3D-View (see Chapter 3.12, "Perspective" parameter).
- 7 Save the parameters applied before saving a point cloud. You can then reload these parameters prior to the point cloud analysis.
- 8 Select the "? → Help" menu item or press the <F1> key to access the description of the measuring program you are currently using.
- 9 If you cannot see any point cloud in the "3D-View" and no error messages are displayed in the status bar, proceed as follows: Reset the parameters to their default settings by using the "Parameters → Reset parameters" menu item. Valid parameters are now loaded into the "Sensor settings", and the complete measuring range is displayed in the 3D-display.

8.3 Key Shortcuts / Mouse Functions

Use the key shortcuts and mouse functions to work faster! There are the following possibilities:

2D-View	
Mouse/key combination	Action
Mouse wheel	Zooms in/out the 2D-View.
Hold Ctrl + left mouse button pressed and move mouse	Moves the data in the 2D-View

3D-View	
Mouse/key combination	Action
Hold left mouse button pressed and move mouse	Rotates the point cloud.
Hold Alt + left mouse button pressed and move mouse	Rotates the point cloud (alternative algorithm).
Hold Ctrl + left mouse button pressed and move mouse up/down or turn mouse wheel	Zooms in/out the point cloud.
Hold Shift + left mouse button pressed and move mouse	Moves the point cloud.

General	
Key shortcut	Action
F1	Opens the online help.
Ctrl + F1	Changes to online mode.
Ctrl + F2	Changes to offline mode.
Ctrl + F3	Save point cloud.
Ctrl + O	Loads parameters from a file.
Ctrl + S	Saves the current parameters to a file.
Ctrl + R	Resets parameters to factory default.
Ctrl + P	Prints the current view.
Ctrl + Y	Restore
Ctrl + Z	Undo

Options	
Key shortcut	Action
Ctrl + F7	Settings
Ctrl + F8	Ethernet Configurator

Measurement	
Key shortcut	Action
F10	Start measuring operation

Note: In case of a malfunction of some key shortcuts please check if these shortcuts are used by other programs.

8.4 Color Palettes

The following color palettes are available for the colored texture of the 2D- and 3D-Views:

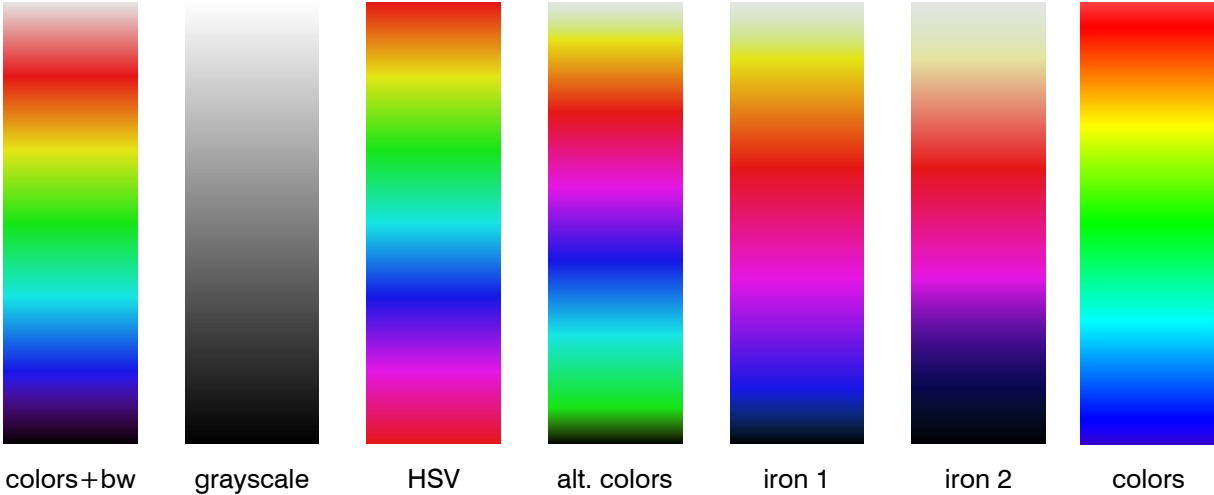

Fig. 8.1. Color palettes for 2D- and 3D-View



MICRO-EPSILON MESSTECHNIK GmbH & Co. KG
Koenigbacher Str. 15 · 94496 Ortenburg / Germany
Tel. +49 (0) 8542 / 168-0 · Fax +49 (0) 8542 / 168-90
info@micro-epsilon.com · www.micro-epsilon.com
Your local contact: www.micro-epsilon.com/contact/worldwide/

X9751426-A062053ALI

© MICRO-EPSILON MESSTECHNIK