



Warnings

Connect the power supply in accordance with the safety regulations for electrical equipment. Ensure that power supply does not exceed specified limits.

> Risk of injury, damage to or destruction of the sensor.

Protect the ends of the optical fibers against contamination, protect the cable against damage.

> Failure of the measuring device

Avoid shocks and impacts to the controller or the sensor.

> Damage to or destruction of the system

Proper Environment

- Protection class: IP65
- Temperature range:
 - Operation: -10 °C ... +55 °C (+14 ... +131 °F)
 - Storage: -10 °C ... +85 °C (+14 ... +185 °F)
- Humidity: 20 ... 80 % RH (non-condensing)
- Ambient pressure: Atmospheric pressure

You can find more information about the sensor in the operating instructions and the interface instructions. They are online at:

www.micro-epsilon.com/download/manuals/man--colorSENSOR-CFO--en.pdf

www.micro-epsilon.com/download/manuals/man--colorSENSOR-CFO-Interfaces--en.pdf

or with the QR codes at right.

Installation

- The supply voltage must not exceed the specified limits.

The colorSENSOR CFO can be placed on a level surface or fastened with the dovetail on the rear of the sensor.

- Position the sensor so that the connections, controls and displays are not concealed. We recommend maintaining a clearance of 2 - 3 cm at the cooling ribs on the left and right sides.

A mounting adapter is available separately for mounting with screws or with a mounting rail (TS35 top-hat rail) according to DIN EN 60715 (DIN rail).



X9771375-A032104HDR

Dimensional Drawing

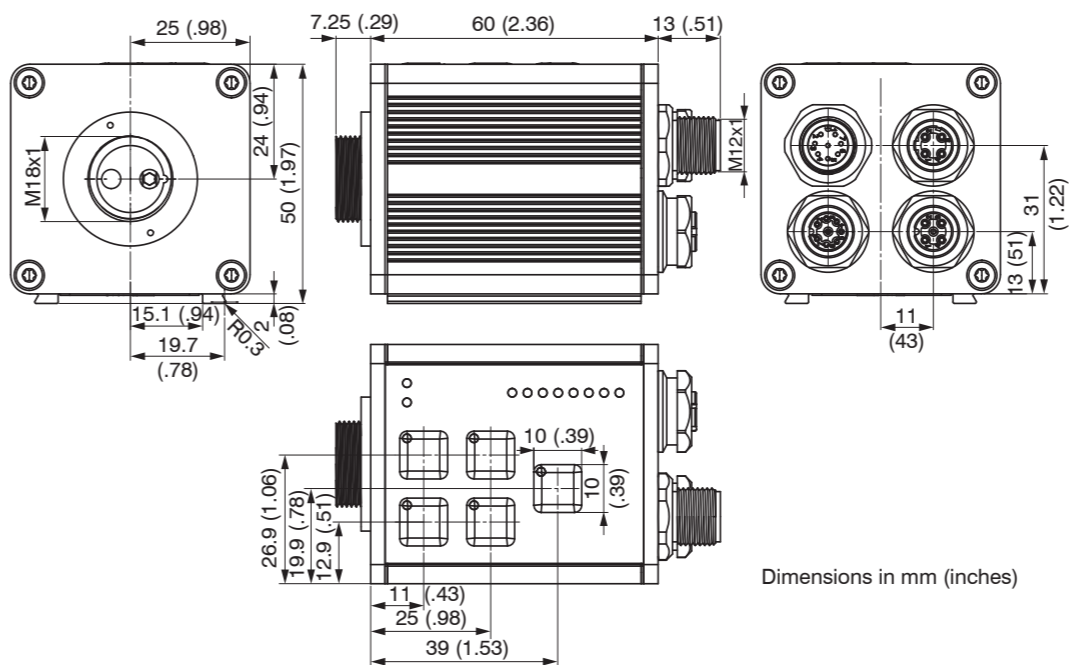

Electrical Connections

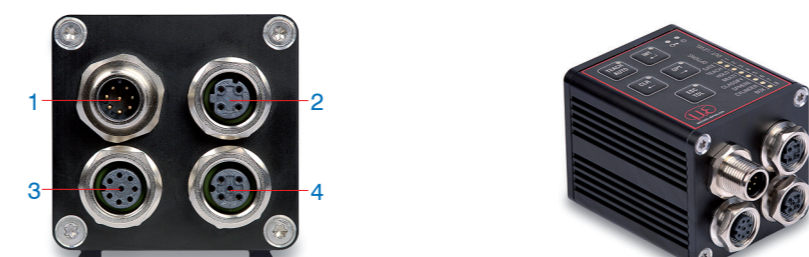

Connector location on colorSENSOR CFO200/CFO250

1	SYS = System (Power/PLC)	Power supply, switching outputs, switching input, RS232
2	ETH = Ethernet	Connection to PC
3	I/O = Digital I/O (PLC), CFO200/CFO250 only	Switching inputs and outputs
4	USB, CFO200/CFO250 only	USB process interface

Electrical connections on colorSENSOR CFO200/CFO250

MICRO-EPSILON Eltrotec GmbH
Manfred-Wörner-Straße 101 • 73037 Göppingen / Germany
Tel. +49 (0) 7161 / 98872-300 • Fax +49 (0) 7161 / 98872-303
eltrotec@micro-epsilon.com • www.micro-epsilon.com
Your local contact: www.micro-epsilon.com/contact/worldwide/

The switching state zero is not used to ensure reliable test performance in the face of a discontinuity. The switching state all switched is recommended as the standard color not detected output.

The cable shield is connected to the housing.

➔ Connect the cable shield to the evaluation unit.

All GND conductors are interconnected with one another and to operating voltage ground.

➔ Use shielded cable with a length < 30 m.

Micro-Epsilon recommends use of the optionally available cable CAB-M12-8P-St-ge.

Pin	Color ²	Function	Description
1	White	IN1	Trigger input
2	Brown	IN2	
3	Green	IN3	
4	Yellow	OUT3	Switching output (NPN/PNP/PP)
5	Gray	OUT4	
6	Pink	OUT5	
7	Blue	OUT6	
8	Red	OUT7	

1) Applies only for colorSENSOR CFO200/CFO250. 2) Conductor color CAB-M12-8P-St-ge

Switching Input Circuit

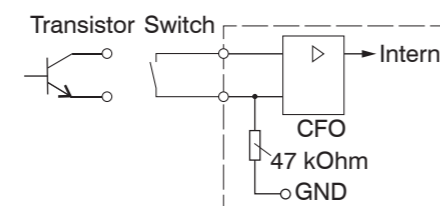

The switching input IN can be connected to the operating voltage potential V_+ as follows.

Model-specific Pin assignments, functions, descriptions and notes about this are available in the operating instructions.

Switching Output Circuit

The switching outputs are connected as follows:

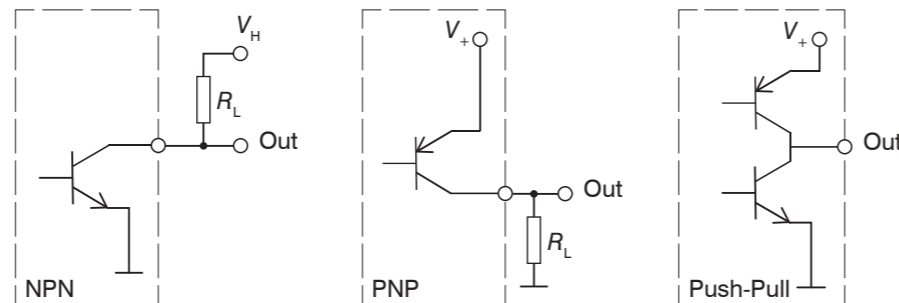

The switching behavior (NPN, PNP, Push-Pull) is programmable. The NPN output is, for example, suitable for adaptation to a local TTL logic circuit with auxiliary voltage of $V_H = 5 V$.

The switching outputs are protected against polarity reversal, overload (< 100 mA), excessive temperature and have an integrated self-induction recuperation diode for inductive loads. Not electrically separated, 24 V logic (HTL), low level GND, high level V_+ (max 28 V)

System, Power and PLC (SYS)

For connection of the power supply, one digital input, process RS232 interface and three digital outputs directly to a PLC.

- 8-pin Male connector
- 24 VDC $\pm 15\%$, $I_{max} < 500 mA$
- not electrically separated, polarity reversal protection, GND is electrically connected to GND for switching outputs.

Pin	Color ¹	Function	Description
1	White	IN0	Trigger input
2	Brown	V_+	Operating voltage (10 - 28 VDC)
3	Green	TX	Terminal (RS 232 transmit)
4	Yellow	RX	Terminal (RS 232 receive)
5	Gray	OUT0	Switching output (NPN/PNP/PP)
6	Pink	OUT1	Switching output (NPN/PNP/PP)
7	Blue	GND	Ground connection
8	Red	OUT2	Switching output (NPN/PNP/PP)

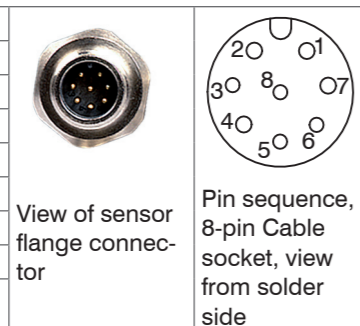

The three switching outputs are switchable push-pull outputs. The switching output logic level depends on the supply voltage V_+ connected.

Use: Direct for 3 individual colors or binary for 7 color groups

The switching state zero is not used to ensure reliable test performance in the face of a discontinuity. The switching state all switched is recommended as the standard color not detected output.

➔ Use shielded cable with a length < 30 m.

Ethernet (ETH)

For data transmission connection to an RJ45 Ethernet connector

- 4-pin female connector
- with Ethernet network (PC)

➔ Connect the sensor to the network using a shielded Ethernet cable (Cat5E) with a length < 100 m. Micro-Epsilon recommends use of the optionally available cable CAB-M12-4P-St-ge ... RJ45-Eth.

Pin	Color ²	Function	Description ²
1	Orange/white	TX+	Ethernet
2	Blue/white	RX+	Ethernet
3	Orange	TX-	Ethernet
4	Blue	RX-	Ethernet

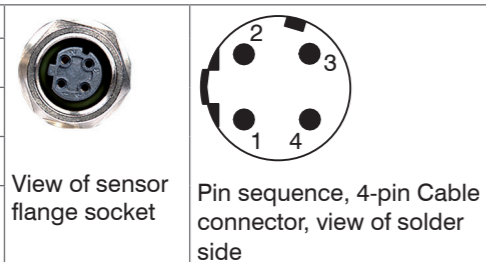

The sensor can be configured using the HTTP-API commands.

- 1) Conductor color CAB-M12-8P-Bu-ge 2) Conductor color CAB-M12-4P-St-ge ... RJ45-Eth2
- 3) Specification pursuant to 100BASE-TX

Digital I/O

The five push-pull switching outputs on the 8-pin connector I/O ¹ are electrically connected to the power supply. The switching output logic level depends on the supply voltage V_+ connected.

Use: Direct for a total of 8 individual colors or binary for 254 color groups.

Operation Using Foil Keyboard

The starting point is the main menu = operating mode/measuring mode: Display of the color group identified/selected setting for No color detected/all LEDs flash - sensor is overmodulated.

Default IP: 169.254.168.150

Submenu	Options / settings				Display / visualization			
 Press and hold > 2 sec.	Intensity menu		Automatic setting to about 80 %	While the settings are performed, the LEDs flash. Duration: about 5 seconds		Number of illuminated LEDs matches intensity All LEDs flash: sensor is overmodulated		
			Intensity higher/lower about 10 %/key press					
 Press and hold > 2 sec.	Color teach menu		Select color group CFO100 1 - 6 CFO200/CFO250 1 - 254	Teaching color: Press < 2 sec.: 1 color Press and hold > 2 sec.: Multi-teach		Flashing Medium-fast ¹ = no color Fast ² = at least 1 color Slow ³ = color within a group is detected.		
			LED of the group flashes.	Delete color group Press and hold > 2 sec.				
 Press and hold > 2 sec.	Delete entire color table	Back to main menu		Tolerance submenu		Tolerance stage higher/lower Tolerance setting, see table at right		Tolerance stage is displayed (1- 8) higher/lower Back to Color teach menu
 Press and hold > 2 sec.	Options menu		Four option groups are possible: Switching input In0: Triggered color evaluation (GATE) or triggered teaching (TEACH) Switching output hold time: 0 ms (LED off), 10 ms (LED flashes briefly), 1000 ms (LED flashes long) Teaching behavior of color groups: Multi-teach on/off Tolerance mode for color detection: CLASSIFY, SPHERE, CYLINDER, BOX	Function: switch on/off/scroll		Flashing Fast = On Slow flashing = Off Or speed of flashing Tolerance mode is displayed directly.		

Back to main menu	
 Press and hold > 2 sec.	Save
 Press and hold > 2 sec.	Cancel

Before	After	Action
Operating mode	Menu mode	Press and hold one of the keys > 2 sec. to change from operating mode to various menus.
Menu mode	Submenu	With the exception of the ESC/TOL key, all keys call a separate menu, see key label. Pressing the TOL key in the TEACH menu calls the submenu for Tolerance adaptation.
Change-over within menu		Press one of the / keys CLR/OPT for < 2 sec. to change over between colors, options, etc. within a menu.
Menu mode	Start action	Press the TEACH/AUTO key for < 2 sec. to start an action.
Menu mode	Operating mode	Press and hold the INT/ENTER key > 2 sec. to save or the ESC/TOL key to cancel and leave menu mode.

Key lock

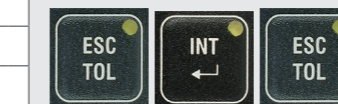

Controls and LEDs

The operating concept, as well as the function of the foil keyboard, are described in the Chapter Foil Keyboard, see operating instructions.

LED/key	Color	Meaning	Location
	Green	Operating voltage present	
	Red	Key lock active	
TEACH AUTO	White	Color teach menu Set level automatically	
INT	White	Automatic illumination adjustment Enter/save	
CLR	White	Delete memory menu Arrow pointing left	
OPT	White	Option selection menu Arrow pointing right	
ESC TOL	White	Escape/quit without saving Tolerance adaptation menu	

Tolerance Setting

Tolerance is subdivided into the following stages:

Tolerance stage	Tolerance space					
	Sphere	Cylinder		Box		
	ΔE_{rel}	ΔL	Δab	ΔL	Δa	Δb
1	0.3	0.6	0.3	0.6	0.3	0.3
2	0.5	1.0	0.5	1.0	0.5	0.5
3	1.0	2.0	1.0	2.0	1.0	1.0
4	2.0	4.0	2.0	4.0	2.0	2.0
5	4.0	8.0	4.0	8.0	4.0	4.0
6	6.0	12.0	6.0	12.0	6.0	6.0
7	8.0	16.0	8.0	16.0	8.0	8.0
8	12.0	24.0	12.0	24.0	12.0	12.0

1) 100 ms on/900 ms off

2) 2 periods:
1.50 ms on/50 ms off
2.50 ms on/850 ms off

3) 900 ms on/100 ms off