



# More Precision.

**optoNCDT ILR** // Laser-optical distance sensors



# Laser distance sensors optoNCDT ILR

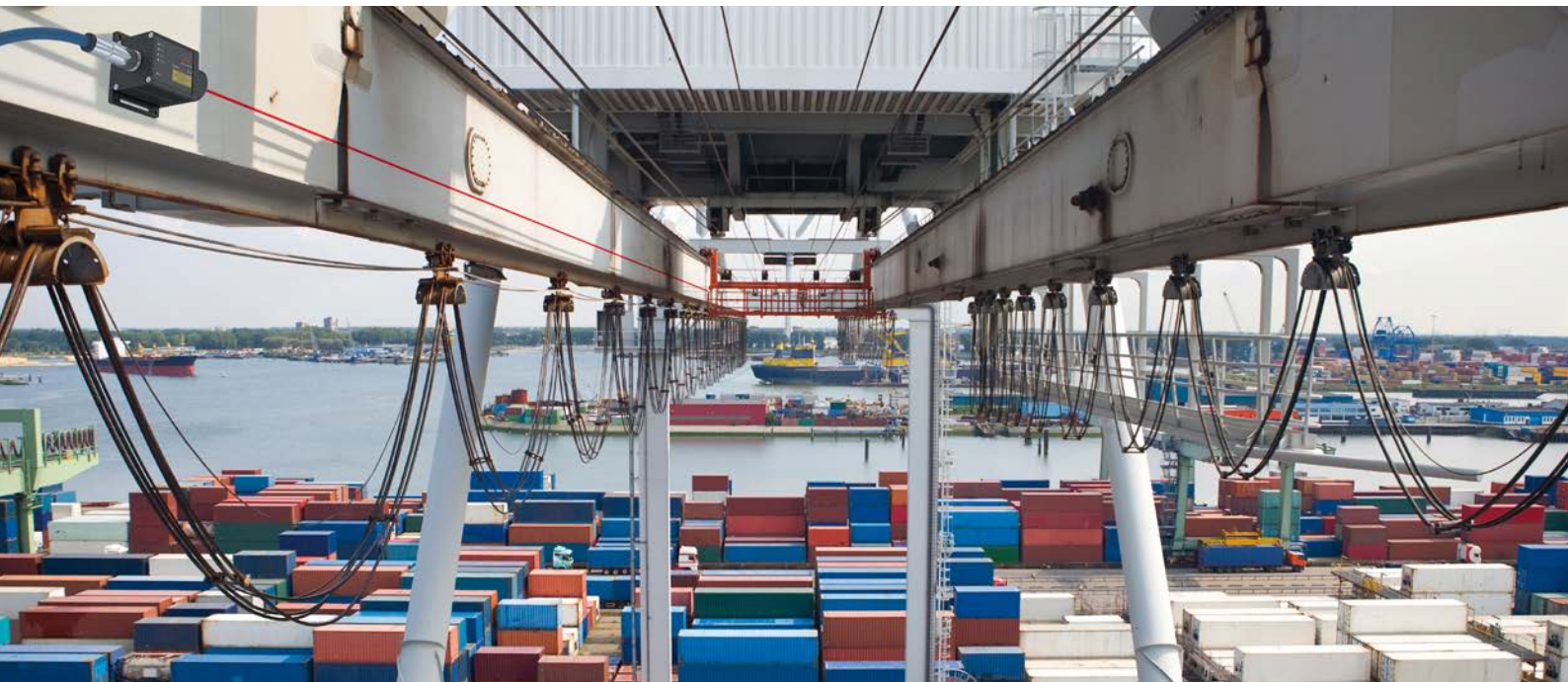

## Laser distance sensors

optoNCDT ILR sensors are optoelectronic sensors for non-contact displacement, distance and also speed measurements. Their large measuring range enables to measure on critical surfaces such as, e.g., hot metals from a safe distance or to regulate large travel displacements. Wear-free measurements and thus a long service life are possible due to the non-contact measuring principle. Depending on the application, three sensor series are available focusing on different aspects (e.g., accuracy, measurement speed). These

sensors are designed for operation with and without reflector and are thus very flexible to use. Due to their robust construction and compact design, the ILR sensors are used indoors and outdoors for many different measurement tasks, both for static and moving measuring objects. The exact positioning of the sensor can be easily achieved by means of switchable sighting lasers or permanently visible measuring lasers.

## Time-of-flight principle

The ILR103x and 1191 sensors operate according to the time-of-flight measuring principle. A laser diode in the sensor produces short laser pulses that are projected onto the target. The light reflected from the target is recorded by the sensor element. The time of flight of the light pulse to the target and back determines the measurement distance. The integrated electronics in the sensor calculates the distance based on the time of flight and conditions the signal for analog and digital output. optoNCDT ILR sensors are resistant to ambient light.

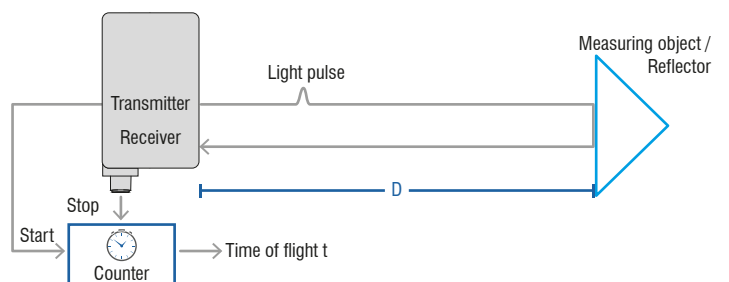

## Phase comparison measuring principle

The ILR2250 sensors operate according to the phase comparison principle. High frequency modulated laser light with low amplitude is transmitted to the target. Depending on the distance of the object, the distance changes the phase relationship between transmitted and received signal. Sensors of this principle work very precisely over measuring ranges up to 150 meters.

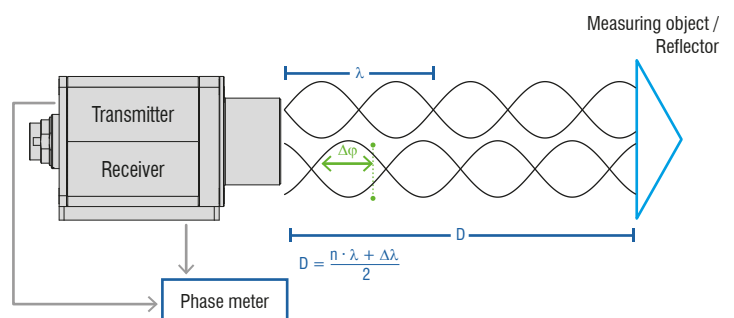

## General information

Special features	4 - 5
Application examples	6 - 7

### Compact and reliable laser distance sensor ILR103x/LC1

8 - 9

Measuring range	Repeatability	Linearity	Resolution	Interfaces	Operating temperature
0.2 - 50 m	<3 mm	< ±20 mm	1 mm	Analog output / Switching output	-30 ... +55 °C

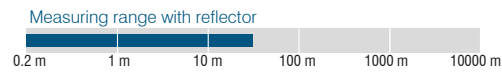
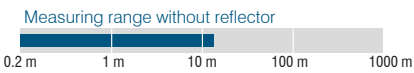

### High-performance laser distance sensor for industrial applications ILR2250-100

10 - 11

Measuring range	Repeatability	Linearity	Resolution	Interfaces	Operating temperature
0.05 - 150 m	< 300 μm	< ±1 mm	0.1 mm	RS422 / USB / PROFINET / EtherNet/IP / IO-Link	-40 ... +65 °C

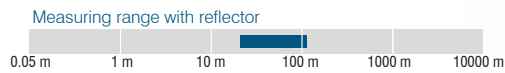

### High-performance laser distance sensor ILR1191-300

12 - 13

Measuring range	Repeatability	Linearity	Resolution	Interfaces	Operating temperature
0.5 - 3000 m	<20 mm	< ±20 - 60 mm	1 mm	RS232 / RS422 / analog output	-40 ... +60 °C

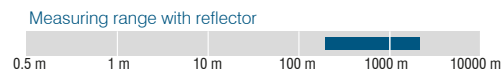
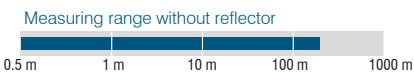

## Accessories

Cables and interface modules	14 - 15
------------------------------	---------

# Laser distance sensors optoNCDT ILR

- IP67
- Laser class 1 (eye-safe)
- Fast response time
- Compact plastic housing



- IP65
- Very precise
- Compact and lightweight
- IO-Link
- Compatible with interface modules
- Integrated mounting plate
- Heating and increased temperature range
- Surface independent
- Comprehensive accessories

- IP67
- Integral heating
- Speed measurement
- Very large measuring ranges

## Industrial Ethernet Connection

The ILR2250-100 sensors can be easily connected to Industrial Ethernet controllers via the IF2030 interface module. The connection is made via the RS422 interface.

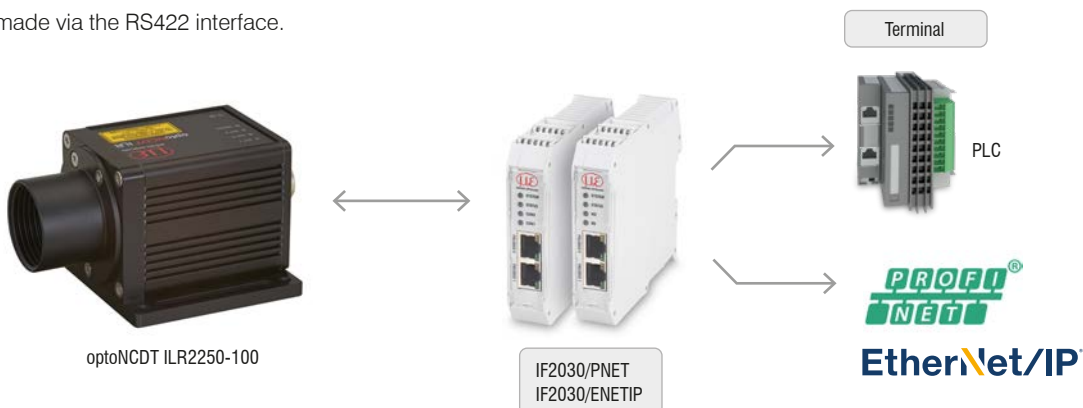



## Parameter Setting via sensorTOOL

The numerous interface modules allow the optoNCDT ILR2250 and ILR1191 sensors to be addressed and parameterized via the sensorTOOL. This sensorTOOL also displays and visualizes a measurement chart.

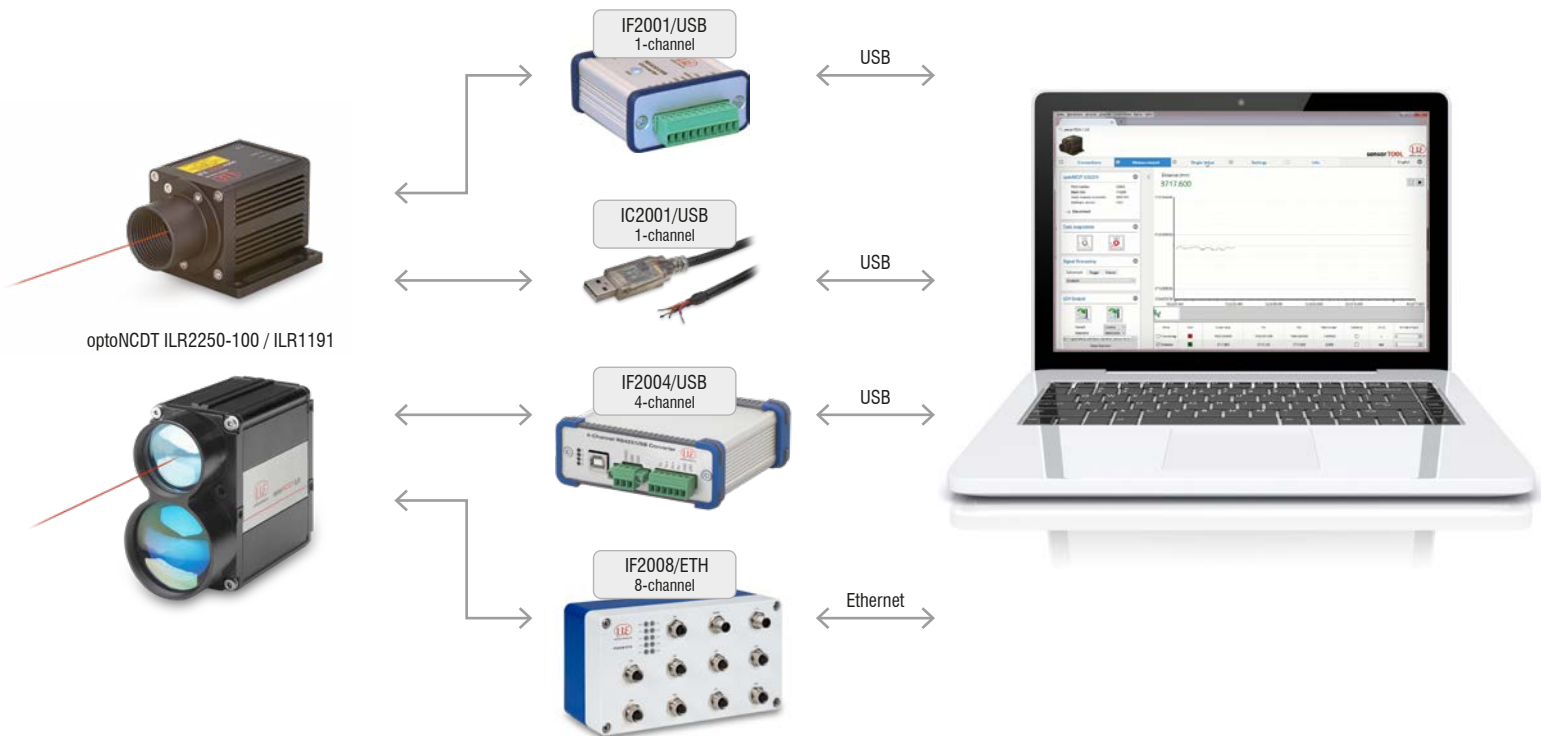

- Data display and scaling via Ethernet and sensorTOOL
- CSV export
- Easy integration without admin rights on PC

The sensorTOOL can be accessed directly via the IF2001/USB, the IF2004/USB and the IF2008/ETH. Besides the parameterization of the sensor, measured values can be displayed, saved and exported.

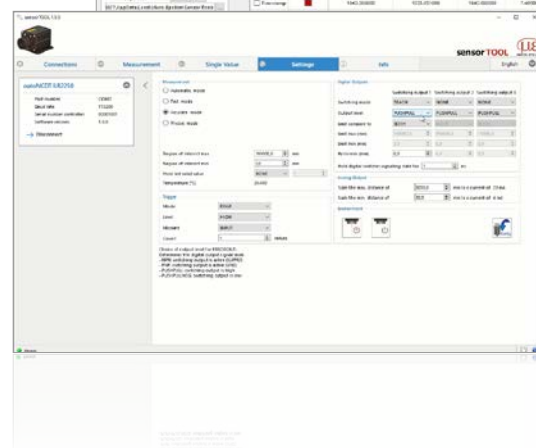
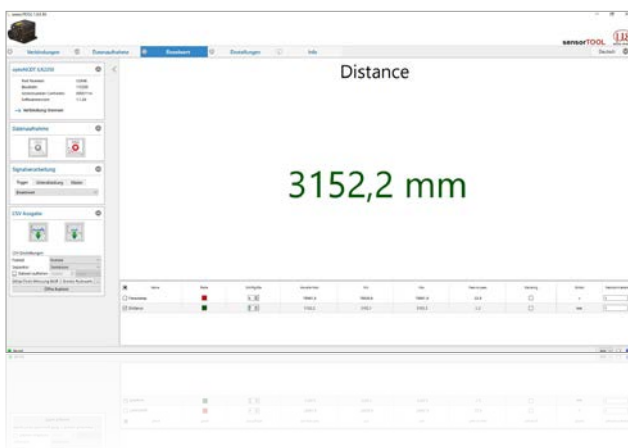

### Measurement modes

- **AUTO mode:** For dark, reflective and distant targets - this measurement mode optimizes the measurement frequency of the sensor and therefore provides the best results, even in difficult conditions.
- **PRECISE mode:** For highest accuracy - this measurement mode provides precise distance values on well reflecting targets.
- **ACCURATE mode:** For high accuracy and tolerance in the event of distance changes.
- **FAST mode:** For fast measurements on moving objects and distance jumps - this measurement mode detects object movements up to 1.6 m/s.

## optoNCDT ILR Laser distance sensors: application examples

### Distance measurements in robot positioning tasks

Automated assembly of cockpits requires the exact positioning of the car bodies. A robot guides the cockpit into the vehicle between the A and B pillars. The correct position at which the car body should stop is determined by optoNCDT ILR1030-8/LC1 time-of-flight laser sensors. They are particularly suitable for these and other comparable applications due to their short response time. The sensor is located on the same side as the assembly robot. Measurements are taken at 100 Hz at the height of the A and B pillars of the vehicle and at a distance of approx. 600 to 700 mm.

Sensor: optoNCDT ILR1030-8/LC1

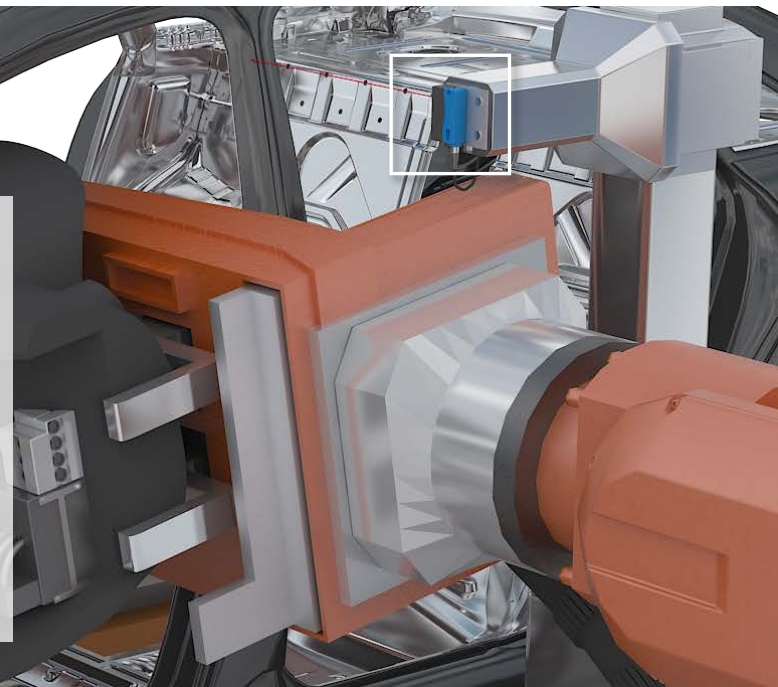

### Diameter measurement of coils

Steel strip coils are mainly used in the processing industry, e.g., the automotive industry. When unwinding the coils, the diameter is continuously monitored by the ILR2250-100-IO in order to be able to determine the changeover time of the coil at an early stage. The IO-Link interface allows for the sensor to be integrated into automation systems. This enables precise and wear-free control of the production process.

Sensor: optoNCDT ILR2250-100-IO

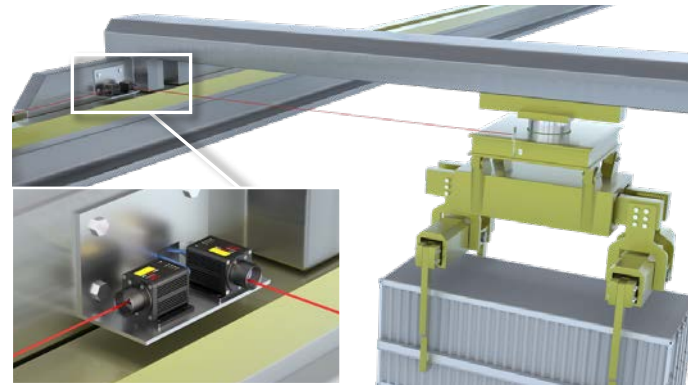

### Position control of indoor cranes

Single girder overhead traveling cranes, double girder bridge cranes and overhead traveling cranes are used in almost every logistics and production plants. The control of the crane system is based on the measurement values of highly accurate ILR2250-100 laser distance sensors from Micro-Epsilon, which are designed for large distances as well as fast distance changes. One sensor detects the change in distance of the main girder, and the second the movement of the trolley.

Sensor: optoNCDT ILR2250-100



### Measurement and position detection of packages

Automation systems such as modern packaging machines require comprehensive information provided by the sensor technology directly from the machine. The detection of the exact position and size of the packages is carried out by the ILR1030 laser distance sensors from Micro-Epsilon. Thanks to laser class 1, they can be used directly without further protective measures. The short response time allows different testing and automation functions of the packaging machine.

Sensor: optoNCDT ILR1030-8/LC1



### Roof and facade surveying with drones

Drones are often used to measure difficult-to-access areas and buildings. The ILR2250-100 is small and compact enough to be easily mounted on the drone.

Sensor: *optoNCDT ILR2250-100*



### Filling level measurement in silos

Laser distance sensors from Micro-Epsilon continuously detect the filling level in silos. For smooth production and logistics processes, precise quantity measurements at storage locations for bulk goods or plastic granulates, for example, is a decisive factor. The ILR2250-100-H sensors are mounted on the lid of the silo and measure continuously towards the silo bottom. This reliable and automated detection of filling levels avoids production downtimes due to missing material.

Sensor: *optoNCDT ILR2250-100-H*

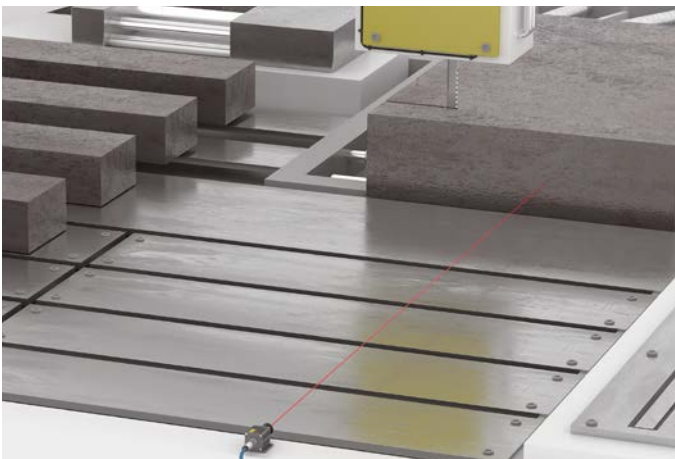

### Fully automatic cross cutting of large slabs

After casting, the aluminum slabs are cut to the required length. The respective length of the slabs is measured continuously. The ILR2250-100 measures the entire length from the front directly onto the face of the slabs. Before sawing, the cut surface has scale and oxidation. After cutting, the face is bright and strongly shiny. The sensor is equipped with a filter glass and provides an optimal distance signal on the different surfaces.

Sensor: *optoNCDT ILR2250-100 with filter glass*

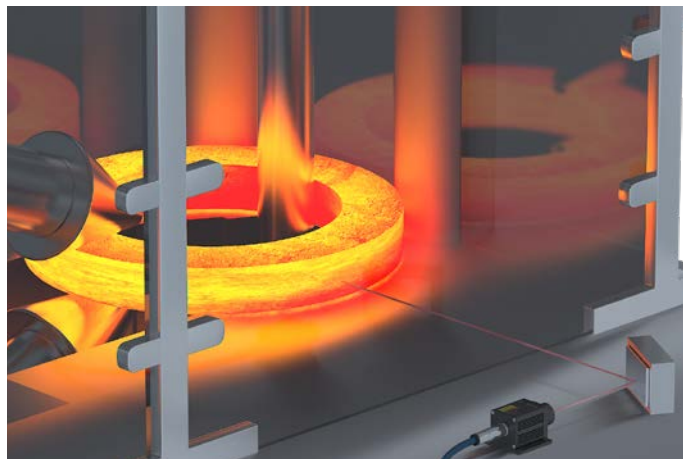







### Diameter monitoring of seamless rolled rings

The processing metal industry uses a wide variety of metals, which are rolled seamlessly into large rings at temperatures of up to 1100 °C by forming. The diameter of the ring increases continuously due to the rolling process. As only minimal tolerances are permitted, the rolling process is continuously monitored by the ILR2250-100-H. Conventional sensors that are mounted close to the measuring object cannot withstand the extremely high temperatures, flaking scale and steam. The ILR2250-100 is ideally designed for this application thanks to the phase comparison method.

Sensor: *optoNCDT ILR2250-100-H*



# Compact and reliable laser distance sensor optoNCDT ILR 103x/LC1

-  Measuring range up to 15 m  
(with reflector 50 m)
-  Ideal for series applications  
automation
-  Laser class 1
-  Robust design IP67
-  Fast response time
-  Compact & lightweight design



The ILR103x/LC1 laser distance sensors operate according to the time-of-flight technology. Based on this technology, these sensors provide accurate, reliable and unambiguous as well as reproducible measurement results regardless of ambient conditions such as surface properties, dark colors or ambient light. The sensors use a measuring laser with laser class 1.

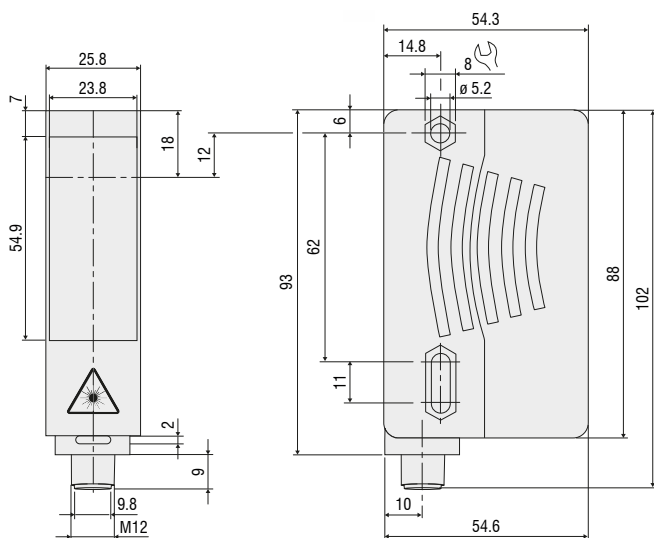

(dimensions in mm, not to scale)

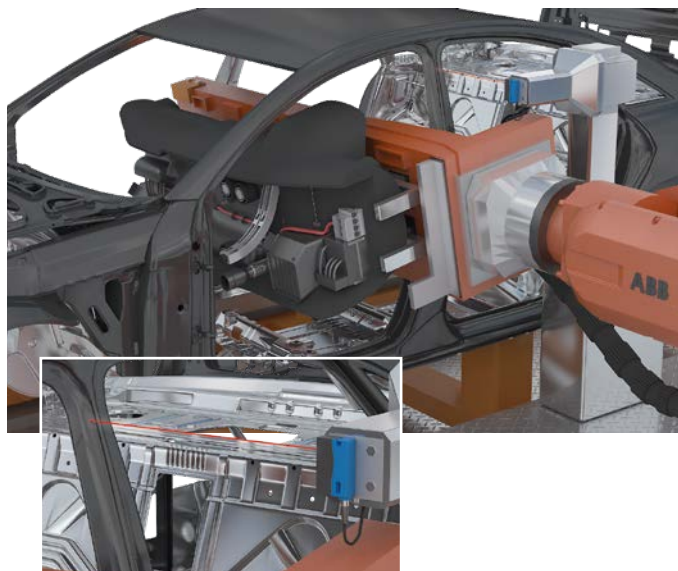

optoNCDT ILR1030-8/LC1  
Distance measurements in robot positioning tasks





Model	ILR1030-8/LC1		ILR1030-15/LC1		ILR1031-50/LC1		
Article number	7112011.01		7112013.01		7112012.01		
Measuring range <sup>1)</sup>		SMR	EMR	SMR	EMR	SMR	EMR
	black 10 %	0.2 m	2.5 m	0.2 m	5 m	-	
	gray 18 %	0.2 m	3.5 m	0.2 m	6 m	-	
	white 90 %	0.2 m	8 m	0.2 m	15 m	-	
	Reflector film <sup>2)</sup>	-		-		0.2 m	50 m
Measuring rate	100 Hz						
Resolution	1 mm						
Linearity <sup>3)</sup>	±25 mm						
Repeatability	<5 mm						
Temperature stability	≤ 0.25 mm / K						
Light source	Semiconductor laser < 1 mW, 660 nm (red)						
Laser class	Class 1 in accordance with DIN EN 60825-1:2007						
Typ. service life	85,000 h						
Permissible ambient light	50,000 lx						
Supply voltage	10 ... 30 VDC						
Power consumption	< 1.5 W (24 V)						
Analog output	4 ... 20 mA, short circuit- and overload-proof, (12 bit D/A, max. load 500 Ohm)						
Switching output	Q1/Q2 push-pull outputs (configurable)						
Connector	Supply/signal: 4-pin M12 screw/plug connection (see accessories for connection cable)						
Assembly	Through bores						
Temperature range	Storage	-30 ... +70 °C (non-condensing)					
	Operation	-30 ... +55 °C (non-condensing)					
Shock (DIN EN 60068-2-27)	25 g / 6 ms in 3 axes						
Vibration (DIN EN 60068-2-6)	2 g / 10 ... 2000 Hz						
Protection class (DIN EN 60529)	IP67						
Material	Plastic housing ABS, plastic pane						
Weight	90 g						
Control and indicator elements	1x LED for power, 1x LED for switch signal 5-step rotary switch for the selection of switching thresholds and analog scaling Button for setting the switching threshold and analog scaling length 660 nm						
Special features	-						

SMR = Start of measuring range, EMR = End of measuring range

The specified data apply for a consistent room temperature of 20 °C, sensor is continuously in operation. Measured on white, diffuse reflecting surface (reference ceramic)

<sup>1)</sup> Depends on the reflectivity of the target, ambient light interference and atmospheric conditions

<sup>2)</sup> ILR-RF250 reflector film 250 x 250 mm; article no: 7966001

<sup>3)</sup> Statistical spread 2  $\sigma$

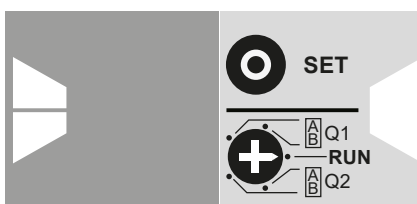

ILR103x: Adjust analog output and switching output via touch keys







#### Spot diameter ILR103x/LC1



The ILR103x/LC1 sensors use a semiconductor laser of class 1. Devices of this laser class require no special safety precautions. They work with a semi-conductor laser with a wavelength of 660 nm (visible/red). Laser power is <1 mW.

# High-performance laser distance sensor for industrial applications

## optoNCDT ILR2250-100

-  Large measuring range up to 100 m (150 m with reflector)
-  Ideal for OEM serial integration
-  Laser class 2
-  Highest signal stability on numerous surfaces
-  Compact & lightweight design
-  Analog / USB / RS422 / PROFINET / EtherNet/IP / IO-Link
-  Now also with integrated heating for outdoor applications



With the optoNCDT ILR2250-100, Micro-Epsilon presents a new powerful laser distance sensor. The sensor is designed for operation with or without reflector film, which is used depending on the distance and ambient conditions. The sensor measures large distances up to 100 m without contact and provides best results even on challenging (dark, structured or weakly reflecting) surfaces. The measuring range can be extended up to 150 m by attaching a reflector film to the measuring object.

Thanks to the integrated AUTO measurement mode, precise and reliable measurements can be made even on dark, partially reflecting and distant targets. A simple and fast alignment of the sensor is made possible by the integrated mounting plate with 4 set screws.

The ILR2250-100 laser distance sensors provide reliable results even under harsh conditions. They are protected against dust and splashes

of water thanks to the robust design in an IP65 certified die-cast aluminum housing. Compact size combined with low weight opens up new fields of application particularly in factory and plant automation, as well as in drone applications for distance measurement from the air.

### New: ILR2250-100-IO with IO-Link

The ILR2250-100-IO model is equipped with an IO-Link interface. The IO-Link communication standard simplifies data communication while reducing the commissioning time of the sensor.

### New: ILR2250-100-H with integrated heating

The ILR2250-100-H option has an integrated heating and cooling element that enables operation in the temperature range of -40 °C to +65 °C. This allows the sensors to be used permanently outdoors.

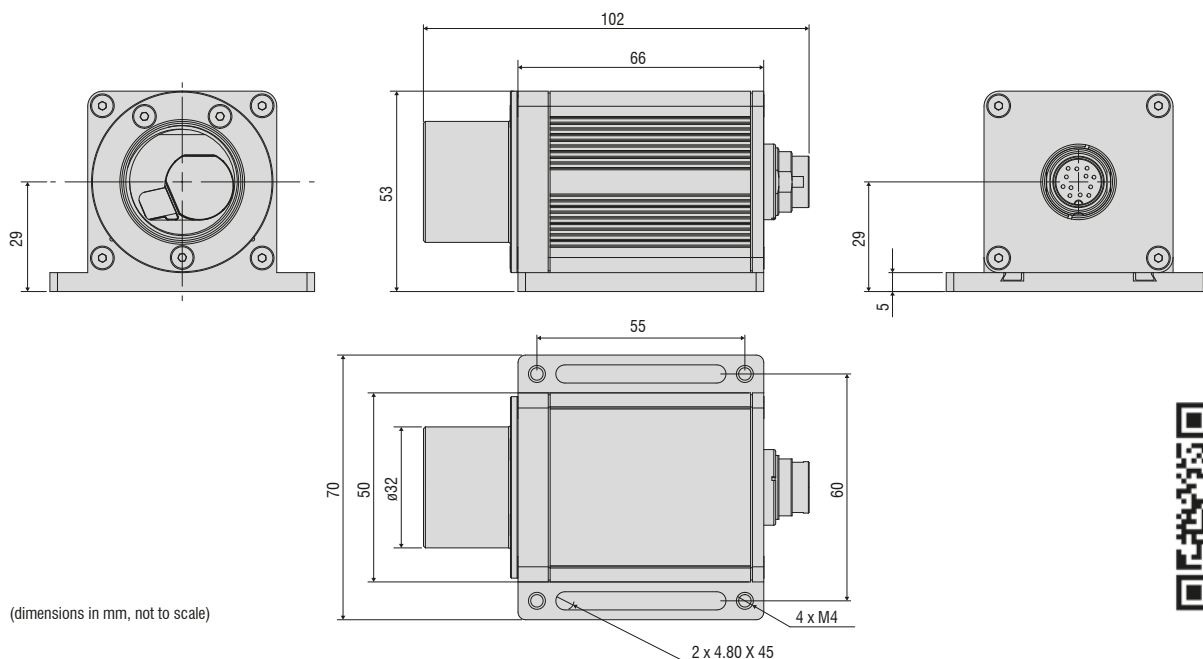

Model	ILR2250-100	ILR2250-100-H	ILR2250-100-IO
Article number	7112015	7112015.200	7112016
Measuring range <sup>1)</sup>	<b>SMR</b>		<b>EMR</b>
	black 6 %	0.05 m	30 m
	gray 40 %	0.05 m	70 m
	white 80 %	0.05 m	100 m
	Reflector film <sup>2)</sup>	35 m	150 m
Measuring rate	20 Hz		
Resolution	0.1 mm		
Linearity	< ±1 mm <sup>3)</sup>		
Repeatability <sup>4)</sup>	< 300 μm		
Temperature compensation	-10 ... +50 °C	-40 ... +65 °C	-10 ... +50 °C
Light source	Semiconductor laser < 1 mW, 655 nm (red)		
Typ. service life	50,000 h		
Laser class	Class 2 in accordance with DIN EN 60825-1: 2015-07		
Permissible ambient light	50,000 lx		
Supply voltage	10 ... 30 VDC	24 ... 30 VDC	10 ... 30 VDC
Power consumption	< 1.5 W (24 V)	< 10 W (24 V)	< 1.5 W (24 V)
Signal input	Trigger		-
Digital interface	RS422 / USB <sup>5)</sup> / PROFINET <sup>5)</sup> / EtherNet/IP <sup>5)</sup>		IO-Link 1.1; process data, parameter set up and diagnostics
Analog output	4 ... 20 mA (16 bit, freely scalable within the measuring range)		-
Switching output	Q1 / Q2 / Q3 (configurable)		Q1 / Q2 / Q3 (configurable) included in IO-Link process data
Connector	Supply/signal: 12-pin M16 screw/plug connection (see accessories for connection cable)		Supply/signal: 5-pin M12 screw/plug connection (see accessories for connection cable)
Assembly	Screwing and adjustment on sensor base plate		
Temperature range	Storage	-25 ... +70 °C (non-condensing)	
	Operation	-10 ... +50 °C (non-condensing)	-40 ... +65 °C (non-condensing)
Shock (DIN EN 60068-2-29)	15 g / 6 ms in 3 axes, in 3 directions, 1000 shocks each		
Vibration (DIN EN 60068-2-6)	15 g / 10 ... 500 Hz in 3 axes, 10 cycles each		
Protection class (DIN EN 60529)	IP65		
Material	Aluminum housing		
Weight	approx. 265 g	approx. 270 g	approx. 265 g
Control and indicator elements	5x LEDs for power, signal strength and switching outputs	5x LEDs for power, signal strength, heating and switching outputs	5x LEDs for power, signal strength and switching outputs
Special features	4 measurement-specific operating modes via sensorTOOL		4 measurement-specific operating modes via IO-Link

SMR = Start of measuring range, EMR = End of measuring range

The specified data apply for a consistent room temperature of 20 °C, sensor is continuously in operation. Measured on white, diffuse reflecting surface (reference ceramic)

<sup>1)</sup> Depends on the reflectivity of the target, ambient light interference and atmospheric conditions

<sup>2)</sup> ILR-RF210 reflector film 210 x 297 mm; article no: 7966058

<sup>3)</sup> Measured in the range of 0.05 ... 20 m; statistical spread 2 σ

<sup>4)</sup> Measurement frequency of 20 Hz, moving average 10

<sup>5)</sup> Connection via interface module (see accessories)

#### Oval spot diameter ILR2250-100

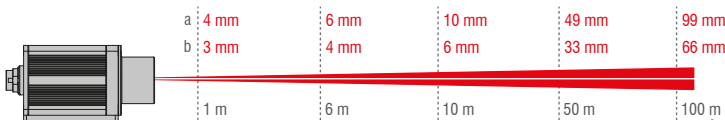

The ILR2250 sensor works with a semiconductor laser at a wavelength of 655 nm (visible/red). Laser power is < 1 mW. The sensors fall within laser class 2. Devices of this laser class require no special safety precautions.

EtherNet/IP®

PROFI  
NET®

Analog







RS422

IO-Link  
inside



# High-performance laser distance sensor for industrial applications

## optoNCDT ILR1191-300

-  Measuring range up to 300 m, (with reflector 3000 m)
-  Distance and speed measurements
-  Measurement laser: laser class 1  
Sighting laser: laser class 2
-  Robust design IP67
-  Very high measuring rate for fast applications
-  Integrated heating

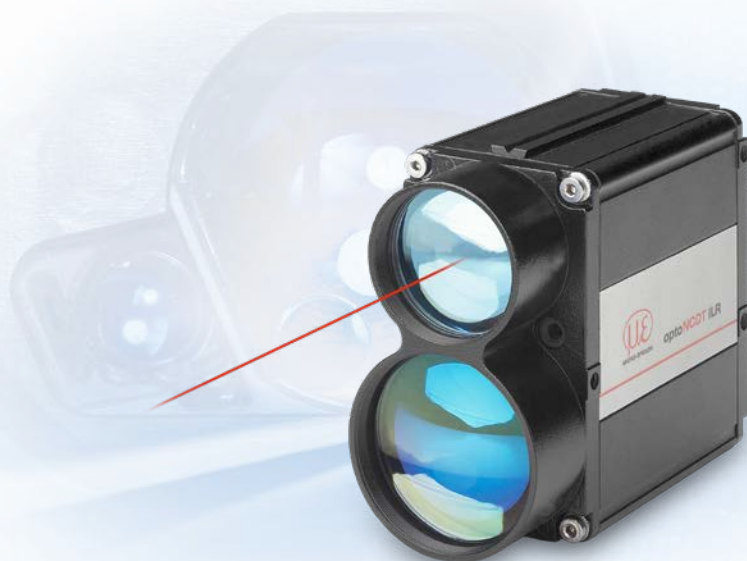

optoNCDT ILR 1191 sensors are optoelectronic sensors for non-contact distance and speed measurement in industrial applications. The sensor is designed for very large measuring ranges, with and without reflector. Due to the very high measuring rate of the sensor, moving objects can be measured easily. The sensor operates according to the laser pulse time-of-flight principle and is therefore particularly

well suited to applications with large distances. Commissioning of the sensor is straightforward due to a variety of interfaces and easy installation options. For outdoor use, the optoNCDT ILR 1191 is equipped with integral heating and protected to IP67.

Models with serial interface

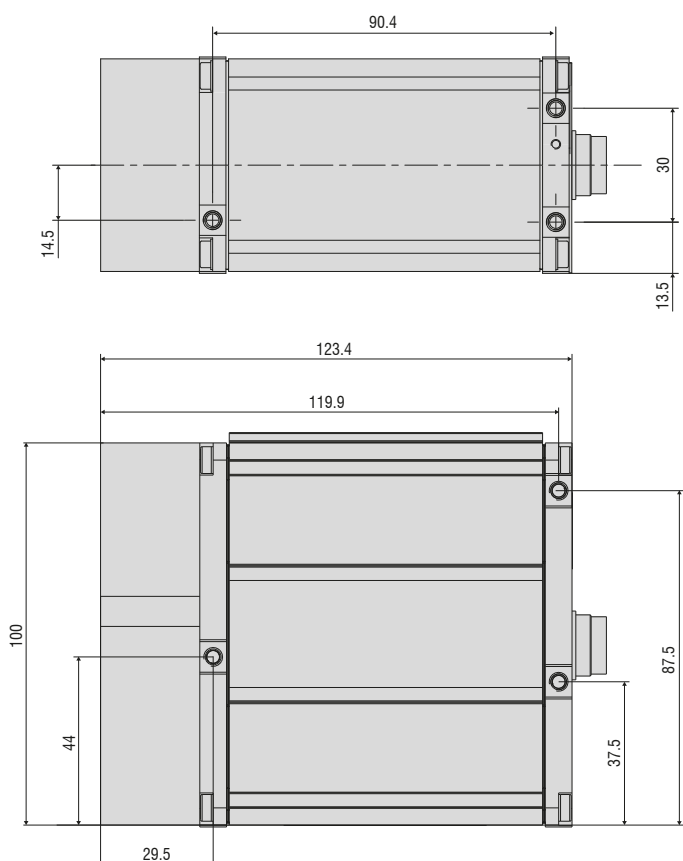

(dimensions in mm, not to scale)

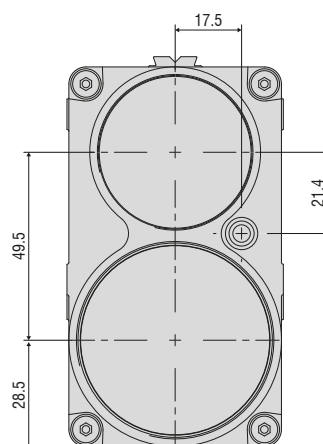

Model	ILR1191-300		
Article number	7112010		
	<b>SMR</b>	<b>EMR</b>	
Measuring range <sup>1)</sup>	black 6 %	8 m	150 m
	gray 10 %	0.5 m	200 m
	white 90 %	0.5 m	300 m
	Reflector film <sup>4)</sup>	0.5 m	3,000 m
Measuring range/speed	0 ... 100 m/s		
Measuring rate	Distance measurement	2,000 Hz	
	Speed measurement	80 Hz	
Resolution	1 mm		
Linearity <sup>2)</sup>	< ±20 mm (at measurement output 100 Hz); < ±60 mm (at measurement output 2 kHz)		
Repeatability <sup>3)</sup>	<20 mm		
Temperature stability	≤ 20 ppm / K		
Light source	Measuring laser	Semiconductor laser < 1 mW, 905 nm (infrared)	
	Sighting laser	Semiconductor laser < 1 mW, 635 nm (red)	
Laser class	Measuring laser	Class 1 in accordance with DIN EN 60825-1:2014	
	Sighting laser	Class 2 in accordance with DIN EN 60825-1:2014	
Permissible ambient light	50,000 lx		
Supply voltage	10 ... 30 VDC		
Power consumption	< 5 W (< 11.5 W with heating)		
Signal input	Trigger		
Digital interface	RS232; RS422 (max 230.4 kBaud)		
Analog output	4 ... 20 mA (16 Bit DA)		
Switching output	Q1 / Q2 (max 200 mA)		
Connector	12-pin M16 connector for supply/RS232/RS422; (connection cable see accessories)		
Assembly	Through-holes M4x6		
Temperature range	Storage	-40 ... +70 °C	
	Operation	-40 ... +60 °C	
Shock (DIN EN 60068-2-29)	15g / 6 ms in 3 axes, 1000 shocks		
Vibration (DIN EN 60068-2-6)	10 g / 10 ... 500 Hz in 3 axes, 10 cycles each		
Protection class (DIN EN 60529)	IP67		
Material	Aluminum housing		
Weight	800 g		
Control and indicator elements	5x LEDs for target, status, switching state and link		
Special features	-		

SMR = Start of measuring range, EMR = End of measuring range

The specified data apply for a consistent room temperature of 20 °C, sensor is continuously in operation. Measured on white, diffuse reflecting surface (reference ceramic)

<sup>1)</sup> Depends on the reflectivity of the target, ambient light interference and atmospheric conditions

<sup>2)</sup> Statistical spread 2  $\sigma$

<sup>3)</sup> Measurement frequency of 100 Hz, moving average 10

<sup>4)</sup> ILR-RF250 reflector film 250 x 250 mm; article no: 7966001

#### Spot diameter ILR1191

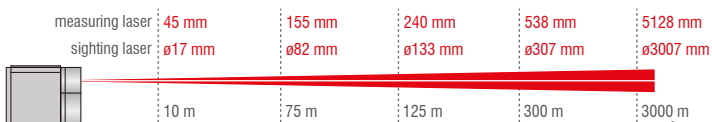

#### Article description







ILR 1191 - 300 (0 x)

Serial interface  
1 = RS232  
2 = RS422

optoNCDT ILR 1191 use a semiconductor class 1 laser (operating mode) and a semiconductor class 2 laser (setup mode). Devices of this laser classes require no special safety precautions.

# Accessories optoNCDT ILR

## Accessories optoNCDT ILR103x/LC1

Connection	Interface modules	Connection cables	Sensor	Accessories
Supply/PLC Power supply unit PS2031 Art. no.: 2420096 		Supply and output cable Art. no.: 2901232 (2 m) 2901233 (2 m, 90°) 2901234 (5 m) 2901235 (5 m, 90°) 2901268 (10 m, 90°) 29011248 (10 m)		Reflector 250 x 250 mm Art. no.: 7966001 
Digital output/Ethernet 	IF1032/ETH Art. no.: 2420066 			







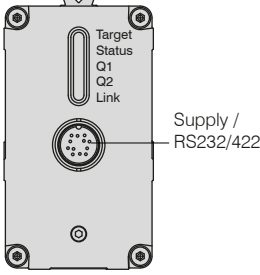

## Accessories optoNCDT ILR2250-100 / ILR2250-100-H / ILR2250-100-IO

Connection	Interface modules	Connection cables	Sensor	Accessories
Supply/PLC Power supply unit PS2031 Art. no.: 2420096 		Supply and output cable Art. no.: 2901524 (3 m) 2901239 (3 m, 90°) 2901573 (5 m) 2901240 (5 m, 90°) 2901236 (10 m) 2901241 (10 m, 90°) 2901237 (20 m) 2901242 (20 m, 90°) 2901238 (30 m) 2901243 (30 m, 90°)	ILR2250-100 ILR2250-100-H 	Reflector 210 x 297 mm Art. no.: 7966058 
PLC Ethernet 	IF2030 for PROFINET Art. no.: 2420087  IF2030 for EtherNet/IP Art. no.: 2420088 			
Digital output/Ethernet 	IF2001/USB Art. no.: 2213025 			Air purge collar Art. no.: 7966062 
	IC2001/USB Art. no.: 2213041 			Protective glass Art. no.: 7966061 
	IF1032/ETH Art. no.: 2420066 			Filter glass Art. no.: 7966063 ILR-NDF 0.75 7966066 ILR-NDF 0.5 7966068 ILR-NDF 0.9 
	IF2004/USB Art. no.: 2213024 	Art. no.: 29011342 (3 m) 29011347 (5 m) 29011348 (10 m) 29011372 (20 m) 2x 2901528 (0.3 m)		
PLC Ethernet 	IF2008/ETH for 8 sensors Art. no.: 2213030 	Art. no.: 29011107 (5 m) 29011398 (3 m) 		
	IO-Link master 	IO-Link standard cable Art. no.: 29011362 (5 m) 29011363 (10 m) 29011364 (15 m) 	ILR2250-100-IO Sensor + adapter cable (0.3 m)  	



# Accessories optoNCDT ILR

## Accessories optoNCDT ILR1 191-300

Connection	Interface modules	Connection cables	Assembly	Accessories
Supply/PLC Power supply unit PS2031 Art. no.: 2420096 		Supply and output cable Art. no.: 2901524 (3 m) 2901239 (3 m, 90°) 2901573 (5 m) 2901240 (5 m, 90°) 2901236 (10 m) 2901241 (10 m, 90°) 2901237 (20 m) 2901242 (20 m, 90°) 2901238 (30 m) 2901243 (30 m, 90°)	Electrical connections 	Reflector 250 x 250 mm Art. no.: 7966001 
Digital output/Ethernet 	IF2001/USB Art. no.: 2213025 			Mounting plate Art. no.: 7966014 
	IF1032/ETH Art. no.: 2420066 			Protection tube Art. no.: 7966016 
				Alignment aid Art. no.: 7966060 

## Sensors and Systems from Micro-Epsilon



Sensors and systems for displacement, position and dimension



Sensors and measurement devices for non-contact temperature measurement



Measuring and inspection systems for quality assurance



Optical micrometers, fiber optics, measuring and test amplifiers



Color recognition sensors, LED Analyzers and inline color spectrometers



3D measurement technology for dimensional testing and surface inspection