



Operating Instructions
thermoMETER CTL

CTL
CTLF
CTLG

CTLM-1
CTLM-2
CTLM-3
CTLM-5

CTLC

Infrared sensor

**MICRO-EPSILON
MESSTECHNIK
GmbH & Co. KG
Koenigbacher Str. 15**

94496 Ortenburg / Germany

Tel. +49 (0) 8542 / 168-0
Fax +49 (0) 8542 / 168-90
e-mail info@micro-epsilon.com
www.micro-epsilon.com

Contents

1.	Safety	7
1.1	Symbols Used	7
1.2	Warnings	7
1.3	Notes on CE Marking	8
1.4	Intended Use	9
1.5	Proper Environment	9
2.	Laser Safety	10
3.	Technical Data	12
3.1	Functional Principle	12
3.2	Sensor Models	13
3.3	General Specifications	14
3.4	Electrical Specifications	15
3.5	Measurement Specifications	16
3.5.1	CTL, CTLF Models	16
3.5.2	CTLM-1 and CTLM-2 Models	17
3.5.3	CTLM-3 Models	18
3.5.4	CTLM-5 Model	19
3.5.5	CTLC Models	20
3.5.6	CTLG Models	21
4.	Delivery	22
4.1	Unpacking, Included in Delivery	22
4.2	Storage	22
5.	Optical Charts	23
6.	Mechanical Installation	37
6.1	Sensor	37
6.2	Controller	38
6.3	Mounting Bracket	39

7.	Electrical Installation.....	40
7.1	Cable Connections	40
	7.1.1 Basic Version	40
	7.1.2 Connector Version.....	40
7.2	Power Supply.....	44
7.3	Cable Assembling.....	45
7.4	Ground Connection	46
	7.4.1 CTLM-5, CTLM-1, CTLM-2, CTLM-3L, CTLM-3H, CTLM-3H1 to -3H3 Models	46
	7.4.2 CTL, CTLF, CTLC-4, CTLC-2, CTLC-6, CTLG Models	47
7.5	Exchange of the Sensor	48
	7.5.1 Entering of the Calibration Code.....	49
	7.5.2 Exchange of the Sensor Cable	50
8.	Outputs and Inputs.....	51
8.1	Analog Outputs.....	51
	8.1.1 Output Channel 1	51
	8.1.2 Output Channel 2 [only for CTL, CTLG]	51
8.2	Digital Interfaces	52
	8.2.1 USB Interface	53
	8.2.1.1 Installation	53
	8.2.1.2 Driver Installation of Interface.....	53
	8.2.2 RS232 Interface	54
	8.2.2.1 Installation	54
	8.2.2.2 Software Installation	54
	8.2.3 RS485 Interface	55
	8.2.3.1 Installation	55
	8.2.3.2 Sensor Installation.....	56
	8.2.4 Profibus Interface	57
	8.2.4.1 Installation	57
	8.2.4.2 Commissioning Profibus	58
	8.2.5 CAN BUS Interface	59
	8.2.6 Modbus RTU.....	62
	8.2.6.1 Serial Interface Parameters.....	62
	8.2.6.2 Protocol	62
	8.2.6.3 Installation Overview	62
	8.2.6.4 Connection of More than one Device (Synchronisation)	65
	8.2.6.5 Overview of Digital Commands for Modbus RTU Digital Interfaces for CT and CTLaser Sensors.....	65

8.2.7	Ethernet Interface	66
8.2.7.1	Installation	66
8.2.7.2	Installation of the Ethernet Adapter in a Network	67
8.2.7.3	Deinstallation of an Ethernet Interface in a Network	68
8.2.7.4	Direct Connection to a PC	71
8.2.7.5	Settings inside the CompactConnect Software	76
8.2.7.6	Resetting the Ethernet Adapter	77
8.3	Relays Outputs	78
8.4	Functional Inputs	79
8.5	Alarms	80
8.5.1	Output Channel 1 and 2 (Channel 2 on CTL, CTLG).....	80
8.5.2	Visual Alarms	80
8.5.3	Open-collector Output / AL2	81
9.	Operation	82
9.1	Sensor Settings	82
9.2	Explanation to the Menu Items	85
9.3	Digital Command Set	87
9.4	Laser Sighting	88
9.5	Error Messages	89
9.5.1	CTL, CTLF, CTLC-4, CTLC-2, CTLC-6, CTLG Models	89
9.5.2	CTLM-5, CTLM-1, CTLM-2, CTLM-3L, CTLM-3H, CTLM-3H1 bis -3H3 Models	89
10.	Instructions for Operation.....	90
10.1	Cleaning	90
11.	CompactConnect Software.....	91
11.1	System Requirements	91
11.2	Main Features	91
12.	Communication Settings.....	92
12.1	Serial Interface	92
12.2	Protocol.....	92
12.3	ASCII Protocol	92
12.4	Saving of Parameter Settings	93
13.	Basics of Infrared Thermometry.....	94

14.	Emissivity.....	95
14.1	Definition	95
14.2	Determination of Unknown Emissivity.....	95
14.3	Characteristic Emissivity.....	96
15.	Liability for Material Defects.....	97
16.	Service, Repair	98
17.	Decommissioning, Disposal	98

Appendix

A 1	Optional Accessories.....	99
A 1.1	Air Purge Collar.....	99
A 1.2	Mounting Bracket	100
A 1.3	Water Cooled Housing	101
A 1.4	High Temperature Cable.....	102
A 1.5	Rail Mount Adapter for Controller.....	102
A 2	Factory Settings	103
A 3	Emissivity Table Metals.....	106
A 4	Emissivity Table Non Metals	109
A 5	Smart Averaging.....	111

1. Safety

System operation assumes knowledge of the operating instructions.

1.1 Symbols Used

The following symbols are used in these operating instructions.



Indicates a hazardous situation which, if not avoided, may result in minor or moderate injury.



Indicates a situation that may result in property damage if not avoided.



Indicates a user action.



Indicates a tip for users.

Measure

Indicates hardware or a software button/menu.

1.2 Warnings



Avoid unnecessary laser radiation to be exposed to the human body.

 Switch off the sensor for cleaning and maintenance.

 Switch off the sensor for system maintenance and repair if the sensor is integrated into a system.

Caution - use of controls or adjustments or performance of procedures other than those specified may cause harm.

Connect the power supply and the display/output device according to the safety regulations for electrical equipment.

> Risk of injury

> Damage to or destruction of the sensor and/or controller



NOTICE

Avoid shocks and impacts to the sensor and the controller.

> Damage to or destruction of the sensor and/or controller

The supply voltage must not exceed the specified limits.

> Damage to or destruction of the sensor and/or controller

Protect the sensor cable against damage.

> Destruction of the sensor, Failure of the measuring device

Do not kink the sensor cable and bend the sensor cable in tight radius. The minimum bending radius is 14 mm (static). A dynamic movement is not allowed.

> Damage to the sensor cable, failure of the measuring device

No solvent-based cleaning agents may have an effect on the sensor (neither for the optics nor the housing)

> Damage to or destruction of the sensor

Avoid static electricity and keep away from very strong EMF (electromagnetic fields) e.g. arc welders or induction heaters.

> Damage to or destruction of the sensor

1.3 Notes on CE Marking

The following apply to the thermoMETER CTL:

- EU Directive 2004/108/EU

- EU Directive 2011/65/EU, "RoHS", category 9

Products which carry the CE mark satisfy the requirements of the EU directives cited and the European harmonized standards (EN) listed therein. The EU Declaration of conformity is available to the responsible authorities according to the EU Directive, article 10, at:

MICRO-EPSILON MESSTECHNIK

GmbH & Co. KG

Koenigbacher Str. 15

94496 Ortenburg / Germany

The measuring system is designed for use in industrial environments and meets the requirements.

1.4 Intended Use

- The thermoMETER CTL is designed for use in industrial and laboratory areas. It is used for non-contact temperature measurement.
- The system must only be operated within the limits specified in the technical data, [see 3](#).
- The system must be used in such a way that no persons are endangered or machines and other material goods are damaged in the event of malfunction or total failure of the sensor.
- Take additional precautions for safety and damage prevention in case of for safety-related applications.

1.5 Proper Environment

- Protection class:
 - Sensor: IP 65 (NEMA 4)
 - Controller: IP 65 (NEMA 4)
- Ambient temperature:
 - Sensor 1: -20 ... +85 °C (-4 ... +185 °F), see also Chapter Measurement Specification, [see 3.3](#)
 - Controller 2: 20 ... +85 °C (-4 ... +185 °F), see also Chapter Measurement Specification, [see 3.3](#)

NOTICE

Avoid abrupt changes of the ambient temperature of both the sensor and the controller.
> Inaccurate measuring values

- Storage temperature:
 - Sensor: See also Chapter Measurement Specification, [see 3.3](#)
 - Controller: -40 ... +85 °C (-40 ... +185 °F)
- Humidity: 10 ... +95 %, non-condensing

1) The sensor can be used at ambient temperatures up to +85 °C without cooling. For applications, where the ambient temperature can reach higher values, the usage of the optional water cooled housing, [see Chap. A 1.3](#), is recommended (ambient temperature up to +175 °C). The sensor should be equipped with the optional high temperature cable (ambient temperature up to +180 °C), [see A 1.4](#)

2) With temperatures < 0 °C (+32 °F), display function is not guaranteed any more.

2. Laser Safety

The thermoMETER CTL sensors operate with a double laser sight with a wavelength of 635 nm (visible/red), see 9.4. The sensors fall within laser class 2 (II). The maximum optical power is ≤ 1 mW.

i Observe the laser protection regulations!

CAUTION

Laser radiation.
Irritation or injury of the eyes possible. Close your eyes or immediately turn away if the laser beam hits the eye.

Although the laser output is low, directly looking into the laser beam must be avoided. Close your eyes or immediately turn away if the laser beam hits the eye. The housing of the optical sensors may only be opened by the manufacturer, see 15. For repair and service purposes, the sensor must always be sent to the manufacturer.

Lasers of class 2 (II) are not subject to notification and a laser protection officer is not required.

The following warning label must be attached to the cover (front side) of the controller housing.



Fig. 1 Laser warning sign and laser label

During operation of the sensor, the pertinent regulations according to IEC 60825-1 on “Safety of laser products” must be fully observed at all times. The sensor complies with all applicable laws for the manufacturer of laser devices. Laser operation is indicated by LED.

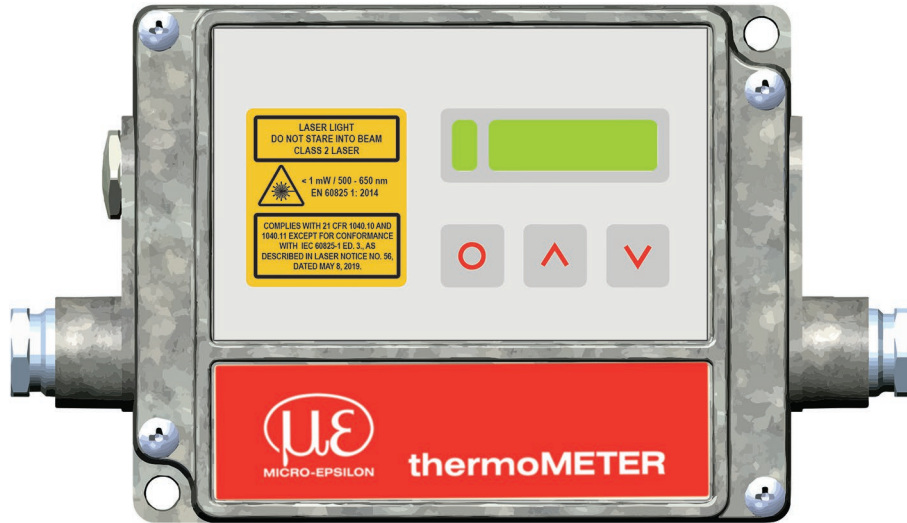

Fig. 2 Controller with laser labels

- i** If the warning label is covered over when the unit is installed, the user must ensure that supplementary label is applied.

3. Technical Data

3.1 Functional Principle

The sensors of the thermoMETER CTL series are non-contact measuring infrared temperature sensors. They calculate the surface temperature based on the emitted infrared energy of objects, see Chap. 12. An integrated double laser aiming marks the real measurement spot location and spot size at any distance on the object surface.

The sensor housing of the thermoMETER CTL is made from stainless steel (protection class IP 65/ NEMA 4), the controller is placed in a separate box made of die casting zinc.

i The thermoMETER CTL sensor is a sensitive optical system. Please only use the thread for mechanical installation.

NOTICE

Avoid mechanical violence on the sensor.

> Destruction of the system

3.2 Sensor Models

Model	Model codes	Spectral response	Typical applications
CTL	-50 to 975 °C	8 - 14 μm	Non-metallic surfaces
CTLF	-50 to 975 °C	8 - 14 μm	Fast processes
CTLM-1	485 to 2200 °C	1 μm	Metals and ceramic surfaces
CTLM-2	250 to 2000 °C	1.6 μm	Metals and ceramic surfaces
CTLM-3	50 to 1800 °C	2.3 μm	Metals and composite materials at low object temperatures (from 50 °C)
CTLG	100 to 1650 °C	5.0 μm	Measurement of glass
CTLC-2	200 to 1450 °C	4.24 μm	Through flames and of CO ₂ / CO- flame gases
CTLC-4		3.9 μm	
CTLC-6		4.64 μm	
CTLM-05	100 to 2000 °C	525 nm	Metals and ceramic surfaces

On the CTLM-1, CTLM-2 and CTLM-3 and CTLG models the whole measuring range is split into three sub ranges (L, H and H1).

3.3 General Specifications

	Sensor	Controller
Protection class	IP 65 (NEMA-4)	
Ambient temperature ¹⁾	-20 ... +85 °C (-4 ... +185 °F)	(-20) 0 ... +85 °C -4 (+32 °F ... +185 °F) ²⁾
Storage temperature	-40 ... +85 °C (-4 ... +185 °F)	
Relative humidity	10 ... 95 %, non condensing	
Material	Stainless steel	Zinc, cast
Dimensions	100 mm x 50 mm, M48x1.5	89 mm x 70 mm x 30 mm
Weight	600 g	420 g
Cable length	3 m (standard), 8 m, 15 m	
Cable diameter	5 mm	
Ambient temperature cable	max. 105 °C (High temperature cable (optional): 180 °C)	
Vibration	IEC 68-2-6: 3 g, 11 – 200 Hz, any axis	
Shock	IEC 68-2-27: 50 g, 11 ms, any axis	
Electromagnetic compatibility (EMC)	EN 61326-1: 2006 / EN 61326-2-3: 2006 / EN 61010-1: 2010	

1) Laser will turn off automatically at ambient temperatures > 50 °C.

2) Bei Temperaturen < 0 °C ist die Funktion des Displays nicht mehr gewährleistet.

3.4 Electrical Specifications

Power supply		8 – 36 VDC
Power consumption		Max. 160 mA
Aiming laser		635 nm, 1 mW, On/ Off via programming keys or software
Outputs/ analog	Channel 1	Selectable: 0/ 4 – 20 mA, 0 – 5/ 10 V, thermocouple (J or K) or alarm output (signal source: Object temperature
	Channel 2 (only CTL/CTLF/ CTLC/CTLG)	Sensor temperature [-20 ... 180 °C] as 0 – 5 V or 0 – 10 V respectively alarm output (signal source switchable to object temperature or controller temperature if used as alarm output)
Alarm output		Open collector output at Pin AL2 (24 V/ 50 mA)
Output impedances	mA	max. loop resistance 500 Ω (at 8 - 36 VDC),
	mV	min. 100 KΩ load impedance
	Thermocouple	20 Ω
Digital interfaces		USB, RS232, RS485, CAN, Profibus DP, Ethernet (via optional plug-in modules)
Relay output		2 x 60 VDC/ 42 VAC _{RMS} , 0.4 A; optically isolated (optional plug-in module)
Functional inputs		F1 to F3; software programmable for the following functions: <ul style="list-style-type: none"> - External emissivity adjustment, - Ambient temperature compensation, - Trigger (reset of hold functions)

3.5 Measurement Specifications

3.5.1 CTL, CTLF Models

Model	CTL	CTLF
Temperature range (scalable)	-50 ... 975 °C	
Spectral range	8 ... 14 μm	
Optical resolution	75:1	50:1
System accuracy ^{1 2}	±1 °C or ±1 % ³	±1,5 °C or ±1,5 % ⁴
Repeatability ¹	±0.5 °C or ±0.5 % ³	±1 °C or ±1 % ⁴
Temperature resolution (NETD)	0.1 °C ³	0.5 °C ⁴
Response time (90 % signal)	120 ms	9 ms
Warm-up time	10 min	
Emissivity/ Gain	0.100 ... 1.100 (adjustable via programming keys or software)	
Transmissivity	0.100 ... 1.100 (adjustable via programming keys or software)	
Signal processing	Average, peak hold, valley hold (adjustable via programming keys or software)	
Software	CompactConnect	

1) At ambient temperature 23 ± 5 °C; whichever is greater.

2) Accuracy for thermocouple output: ±2.5 °C or ±1 %

3) At object temperatures > 0 °C

4) At object temperatures ≥ 20 °C

3.5.2 CTLM-1 and CTLM-2 Models

Model	M-1L	M-1H	M-1H1	M-2L	M-2H	M-2H1
Temperature range (scalable)	485/1050 °C	650/1800 °C	800/2200 °C	250/800 °C	385/1600 °C	490/2000 °C
Spectral range	1 μm			1.6 μm		
Optical resolution	150:1	300:1		150:1	300:1	
System accuracy ^{1 2}	±(0.3 % T of reading +2 °C) ³					
Repeatability ¹	±(0.1 % T of reading +1 °C) ³					
Temperature resolution (NETD)	0.1 °C					
Exposure time (90 % signal)	1 ms ⁴					
Emissivity/ Gain	0.100 ... 1.100 (adjustable via programming keys or software)					
Transmissivity	0.100 ... 1.100 (adjustable via programming keys or software)					
Signal processing	Average, peak hold, valley hold (adjustable via programming keys or software)					
Software	CompactConnect					

1) At ambient temperature 23 ±5 °C; whichever is greater.

2) Accuracy for thermocouple output: ±2,5 °C or ±1 %

3) $\varepsilon = 1 / \text{Response time } 1 \text{ s}$

4) With dynamic adaptation at low signal levels

3.5.3 CTLM-3 Models

Model	M-3L	M-3H	M-3H1	M-3H2	M-3H3
Temperature range (scalable) ^{1 2}	50/400 °C	100/600 °C	150/1000 °C	200/1500 °C	250/1800 °C
Spectral range	2.3 μm				
Optical resolution	60:1	100:1	300:1		
System accuracy ^{3 5}	±(0.3 % of reading + 2 °C) ³				
Repeatability ³	±(0.1 % of reading + 1 °C) ³				
Temperature resolution (digital)	0.1 °C				
Exposure time (90 % signal) ⁴	1 ms ⁴				
Emissivity/ Gain ¹	0.100...1.100 (adjustable via programming keys or software)				
Transmissivity/ Gain ¹	0.100...1.100 (adjustable via programming keys or software)				
Signal processing ¹	Average, peak hold, valley hold (adjustable via programming keys or software)				
Software	CompactConnect				

1) Adjustable via controller or software

2) Target temperature > sensor temperature + 25 °C

3) E = 1, response time 1 s; ambient temperature 23 ± 5 °C

4) With dynamic adaptation at low signal levels

5) Accuracy for thermocouple output: ±2,5 °C or ±1 %

3.5.4 CTLM-5 Model

Model	M-5
Temperature range ¹	1000/2000 °C
Spectral range	525 nm
Optical resolution	150:1
System accuracy ^{2,4}	$\pm(0.3 \% \text{ of reading} + 2 \text{ }^\circ\text{C})$ ²
Repeatability ²	$\pm(0.1 \% \text{ of reading} + 1 \text{ }^\circ\text{C})$ ²
Temperature resolution	0.2 °C
Response time (90 % signal) ³	1 ms ³
Emissivity/ gain ¹	0.100...1.100
Transmissivity/ gain ¹	0.100...1.100
Signal processing ¹	Peak hold, valley hold, average; extended hold function with threshold and hysteresis
Software	CompactConnect

1) Adjustable via controller or software

2) E = 1, response time 1 s; ambient temperature 23 \pm 5 °C

3) With dynamic adaptation at low signal levels

4) Accuracy for thermocouple output: $\pm 2,5$ °C or ± 1 %

3.5.5 CTLC Models

Model	C-2 ⁶	C-4 ⁶	C-6 ⁶
Temperature range ¹	200/1450 °C		
Spectral range	4.24 μm	3.9 μm	4.64 μm
Optical resolution	45:1		
System accuracy ^{3 4 5}	±1 %		
Repeatability ³	±0.5 % or ±0.5 °C		
Temperature resolution (digital)	0.1 °C		
Response time (90 % signal) ²	10 ms		
Emissivity/ gain ¹	0.100...1.100		
Transmissivity/ gain ¹	0.100...1.100		
Signal processing ¹	Peak hold, valley hold, average; extended hold function with threshold and hysteresis		
Software	CompactConnect		

1) Adjustable via programming keys or software

2) With dynamic adaptation at low signal levels

3) At ambient temperature 23 ±0.5 °C; whichever is greater; temperature of the object ≥ 0 °C

4) $\epsilon = 1$, response time 1 s

5) Accuracy for thermocouple output: ±2,5 °C or ±1 %

6) Models C-2, C-4, C-6 also known as H-models with 400 ... 1650 °C.

3.5.6 CTLG Models

Model	G-L	G-H	GF-H
Temperature range ¹	100 ... 1200 °C	250 ... 1650 °C	200 ... 1450 °C
Spectral range	5.0 μm		
Optical resolution	45:1	70:1	45:1
System accuracy ^{2,3}	±1 °C or ±1.5 %		
Repeatability ²	±0.5 °C or ±0.5 %		
Temperature range (NETD)	0.1 °C		
Exposure time (90 % signal)	120 ms	80 ms	
Warm-up time	10 min		
Emissivity/ Gain ¹	0.100 ... 1.100 (adjustable via programming keys or software)		
Transmissivity ¹	0.100 ... 1.100 (adjustable via programming keys or software)		
Signal processing	Average, peak hold, valley hold (adjustable via programming keys or software)		
Software	CompactConnect		

1) Adjustable via controller or software



2) At ambient temperature 23 ±5 °C; whichever is greater.

3) Accuracy for thermocouple output: ±2,5 °C or ±1 %

4. Delivery

4.1 Unpacking, Included in Delivery

- 1 thermoMETER CTL sensor
- 1 Controller
- 1 Sensor cable
- 1 Mounting nut and mounting bracket (fixed)
- 1 Operating instructions

-  Carefully remove the components of the measuring system from the packaging and ensure that the goods are forwarded in such a way that no damage can occur.
-  Check the delivery for completeness and shipping damage immediately after unpacking.
-  If there is damage or parts are missing, immediately contact the manufacturer or supplier.

You will find optional accessories in appendix, [see A 1](#).

4.2 Storage

- Storage temperature: -40 ... 85 °C (-4 ... +185 °F)
- Humidity: 10 ... 95 %

5. Optical Charts

The following optical charts show the diameter of the measuring spot in dependence on the distance between measuring object and sensor. The spot size refers to 90 % of the radiation energy. The distance is always measured from the front edge of the sensor.

i The size of the measuring object and the optical resolution of the infrared thermometer determine the maximum distance between sensor and measuring object. In order to prevent measuring errors the object should fill out the field of view of the optics completely. Consequently, the spot should at all times have at least the same size like the object or should be smaller than that.

D = Distance from front of the sensor to the object

S = Spot size

CTL

Optics: SF

D:S (Focus distance) = 75:1

16 mm @ 1200 mm

D:S (Far field) = 24:1

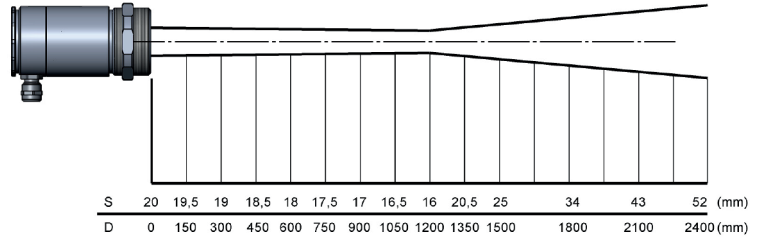

CTL

Optics: CF1

D:S (Focus distance) = 75:1

0.9 mm @ 70 mm

D:S (Far field) = 3.5:1

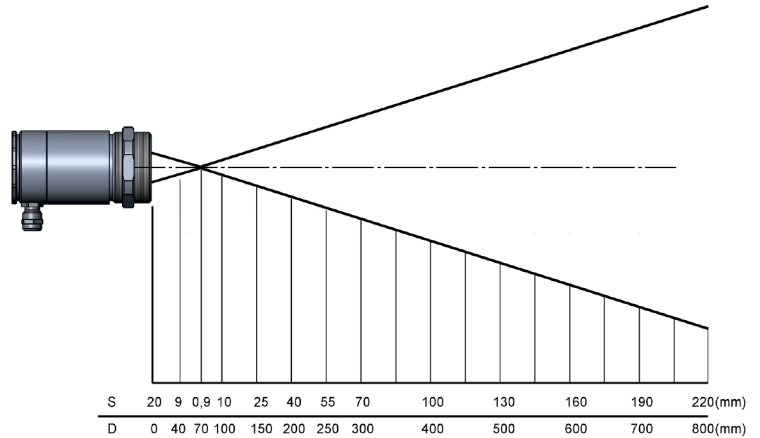

CTL

Optics: CF2
 D:S (Focus distance) = 75:1
 1.9 mm @ 150 mm
 D:S (Far field) = 7:1

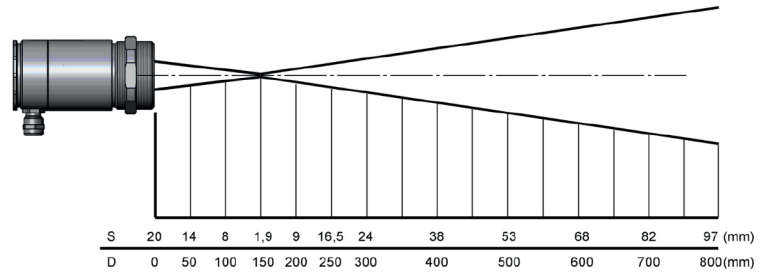

CTL

Optics: CF3
 D:S (Focus distance) = 75:1
 2.75 mm @ 200 mm
 D:S (Far field) = 9:1

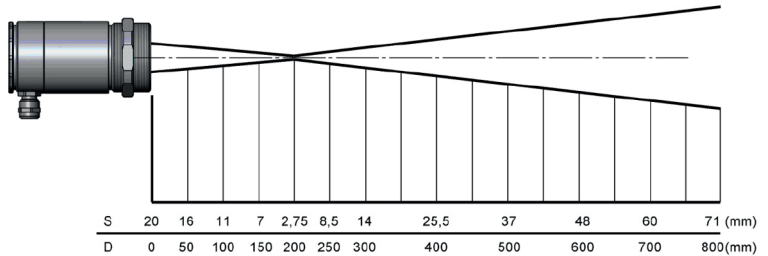

CTL

Optics: CF4
 D:S (Focus distance) = 75:1
 5.9 mm @ 450 mm
 D:S (Far field) = 18:1

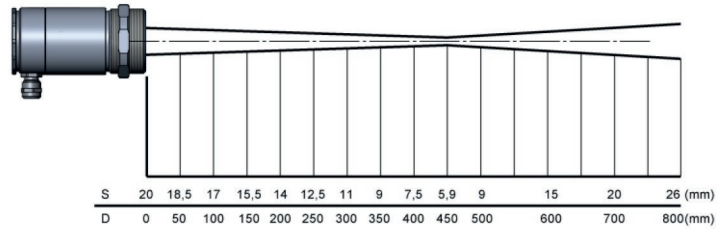

CTLF

Optics: SF
 D:S (Focus distance) = 50:1
 24 mm @ 1200 mm
 D:S (Far field) = 20:1

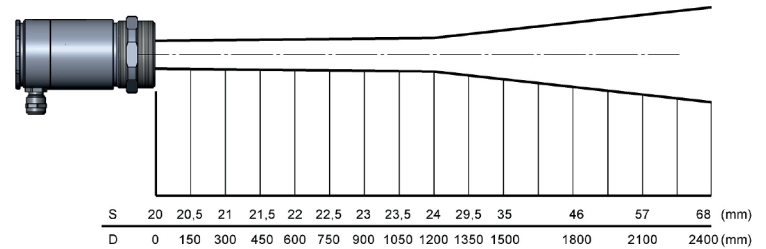

CTLF

Optics: CF1

D:S (Focus distance) = 50:1

1.4 mm @ 70 mm

D:S (Far field) = 3.5:1

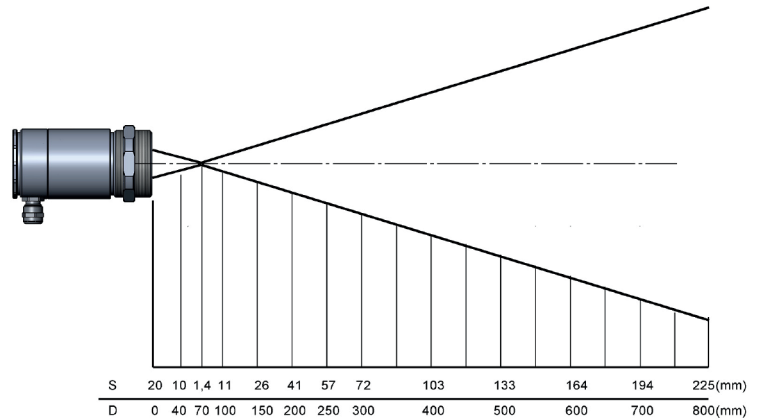

CTLF

Optics: CF2

D:S (Focus distance) = 50:1

3 mm @ 150 mm

D:S (Far field) = 6:1

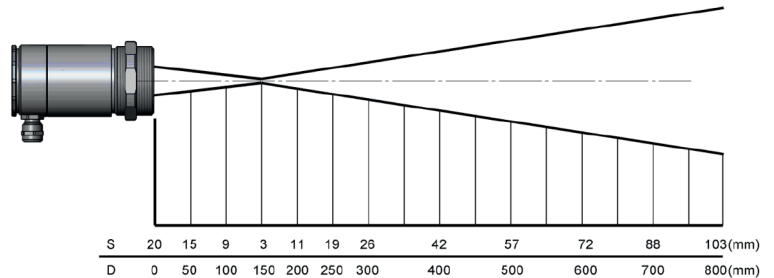

CTLF

Optics: CF3
 D:S (Focus distance) = 50:1
 4 mm @ 200 mm
 D:S (Far field) = 8:1

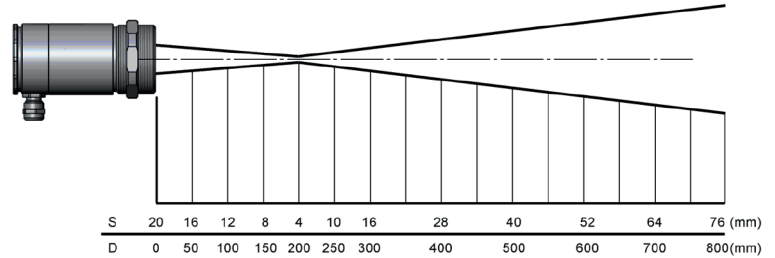

CTLF

Optics: CF4
 D:S (Focus distance) = 50:1
 9 mm @ 450 mm
 D:S (Far field) = 16:1

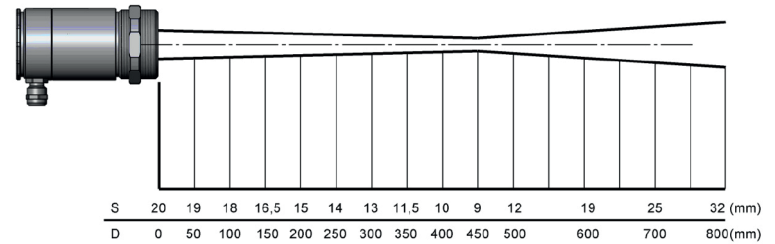

**M-1H/ M-1H1/ M-2H/ M-2H1/
M-3H1/ M-3H2/ M-3H3**

Optics: FF
 D:S (Focus distance) = 300:1
 12 mm @ 3600 mm
 D:S (Far field) = 115:1

M-1L/ M-2L / M-5-1L/ M-5-2L

Optics: FF
 D:S (Focus distance) = 150:1
 24 mm @ 3600 mm
 D:S (Far field) = 150:1

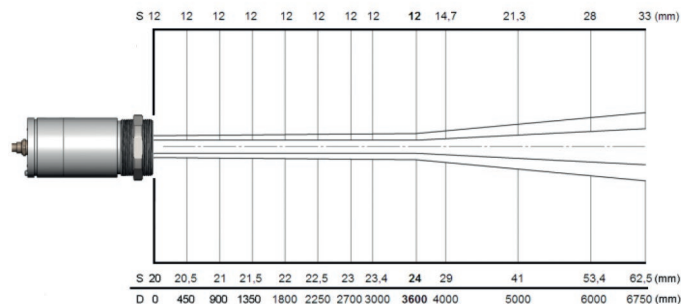

**M-1H/ M-1H1/ M-2H/ M-2H1/
M-3H1/ M-3H2/ M-3H3**

Optics: SF
 D:S (Focus distance) = 300:1
 3.7 mm @ 1100 mm
 D:S (Far field) = 48:1

M-1L/ M-2L / M-51L /2L

Optics: SF
 D:S (Focus distance) = 150:1
 7.3 mm @ 1100 mm
 D:S (Far field) = 42:1

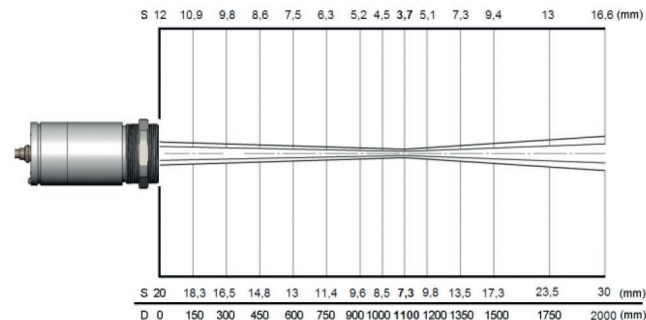

**M-1H/ M-1H1/ M-2H/ M-2H1/
M-3H1/ M-3H2/ M3-H3**

Optics: CF2
 D:S (Focus distance) = 300:1
 0.5 mm @ 150 mm
 D:S (Far field) = 7.5:1

M-1L/ M-2L

Optics: CF2
 D:S (Focus distance) = 150:1
 1 mm @ 150 mm
 D:S (Far field) = 7:1

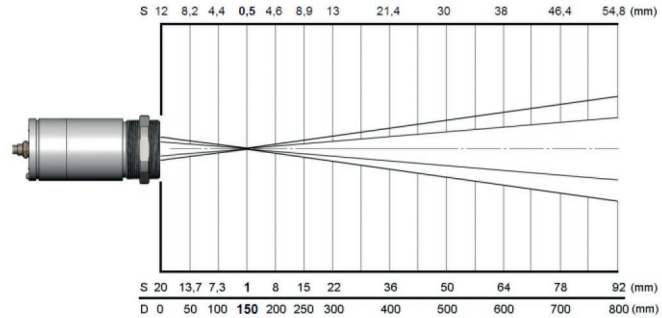

**M-1H/ M-1H1/ M-2H/ M-2H1/
M-3H1/ M-3H2/ M3-H3**

Optics: CF3
 D:S (Focus distance) = 300:1
 0.7 mm @ 200 mm
 D:S (Far field) = 10:1

M-1L/ M-2L

Optics: CF3
 D:S (Focus distance) = 150:1
 1.3 mm @ 200 mm
 D:S (Far field) = 10:1

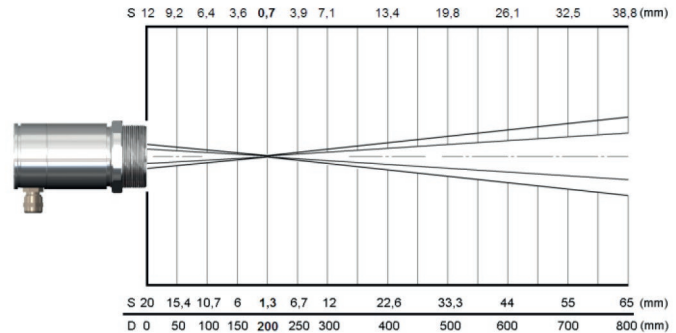

**M-1H/ M-1H1/ M-2H/ M-2H1/
M-3H1/ M-3H2/ M3-H3**

Optics: CF4
 D:S (Focus distance) = 300:1
 1.5 mm @ 450 mm
 D:S (Far field) = 22:1

M-1L/ M-2L

Optics: CF4
 D:S (Focus distance) = 150:1
 3 mm @ 450 mm
 D:S (Far field) = 20:1

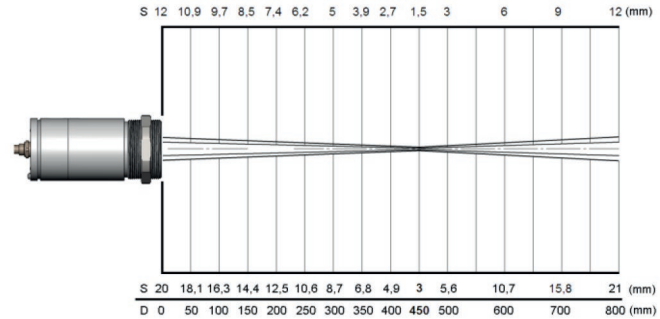

M-3H

Optics: SF
 D:S (Focus distance) = 100:1
 11 mm @ 1100 mm
 D:S (Far field) = 4:1

M-3L

Optics: SF
 D:S (Focus distance) = 60:1
 18,3 mm @ 1100 mm
 D:S (Far field) = 4:1

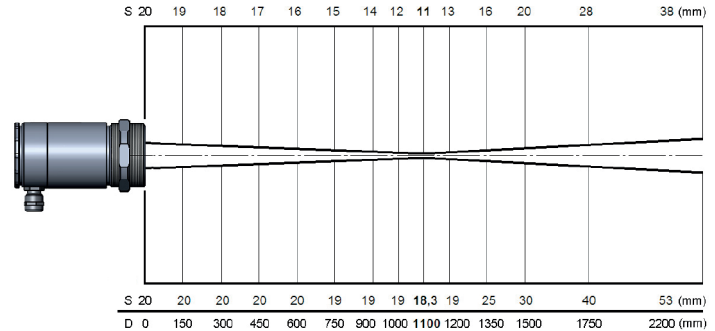

M-3H

Optics: CF1
 D:S (Focus distance) = 100:1
 0,85 mm @ 85 mm
 D:S (Far field) = 3:1

M-3L

Optics: CF1
 D:S (Focus distance) = 60:1
 1.4 mm @ 85 mm
 D:S (Far field) = 3:1

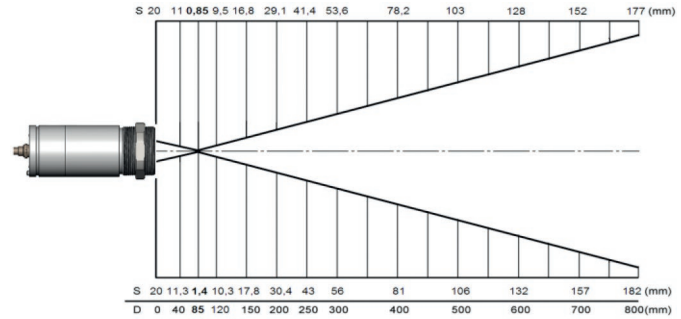

M-3H

Optics: CF2
 D:S (Focus distance) = 100:1
 1.5 mm @ 150 mm
 D:S (Far field) = 7:1

M-3L

Optics: CF2
 D:S (Focus distance) = 60:1
 2.5 mm @ 150 mm
 D:S (Far field) = 6:1

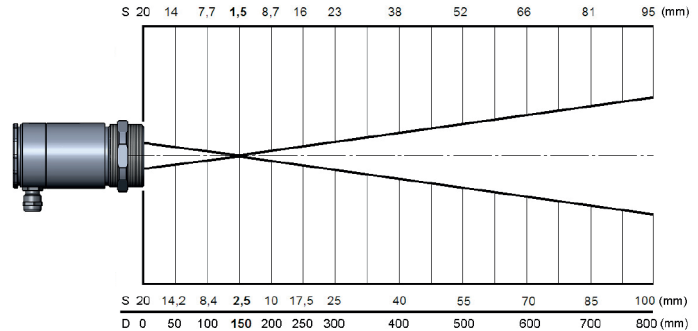

M-3H

Optics: CF3
 D:S (Focus distance) = 100:1
 2 mm @ 200 mm
 D:S (Far field) = 9:1

M-3L

Optics: CF3
 D:S (Focus distance) = 60:1
 3.4 mm @ 200 mm
 D:S (Far field) = 8:1

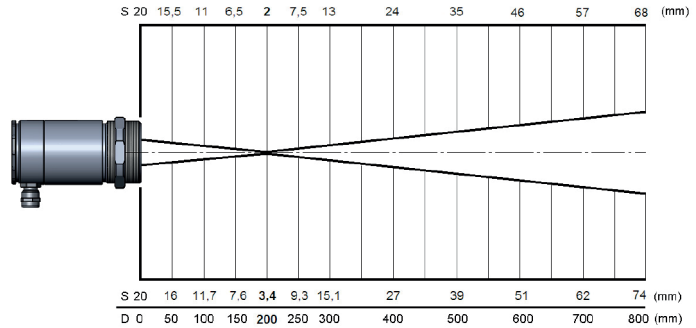

M-3H

Optics: CF4
 D:S (Focus distance) = 100:1
 4.5 mm @ 450 mm
 D:S (Far field) = 19:1

M-3L

Optics: CF4
 D:S (Focus distance) = 60:1
 7.5 mm @ 450 mm
 D:S (Far field) = 17:1

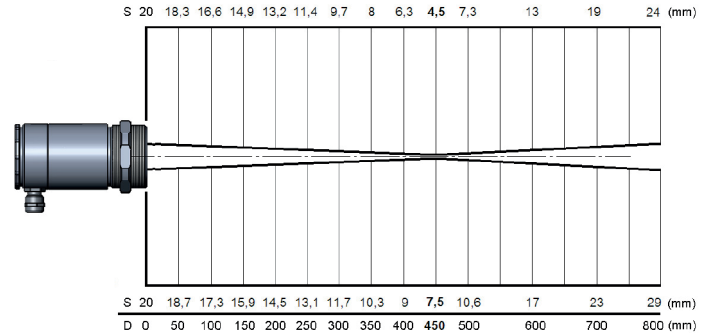

**GL / CTLC-4 / CTLC-2 /
CTLC-6**

Optics: SF
 D:S (Focus distance) = 45:1
 27 mm @ 1200 mm
 D:S (Far field) = 25:1

GH

Optics: SF
 D:S (Focus distance) = 70:1
 17 mm @ 1200 mm
 D:S (Far field) = 33:1

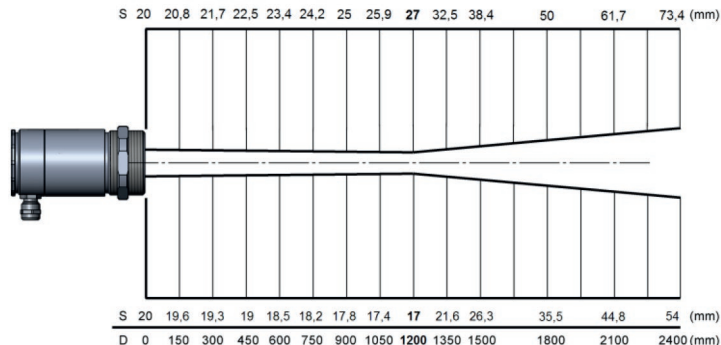

**GL / CTLC-4 / CTLC-2 /
CTLC-6**

Optics: CF1
 D:S (Focus distance) = 45:1
 1.6 mm @ 70 mm
 D:S (Far field) = 3:1

GH

Optics: CF1
 D:S (Focus distance) = 70:1
 1 mm @ 70 mm
 D:S (Far field) = 3.4:1

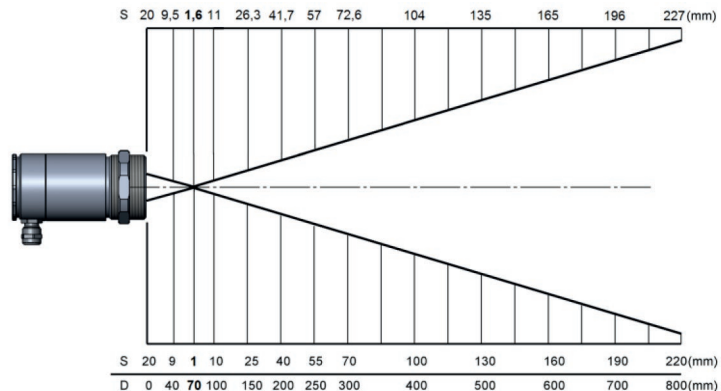

**GL / CTLC-4 / CTLC-2 /
CTLC-6**

Optics: CF2
 D:S (Focus distance) = 45:1
 3.4 mm @ 150 mm
 D:S (Far field) = 6:1

GH

Optics: CF2
 D:S (Focus distance) = 70:1
 2.2 mm @ 150 mm
 D:S (Far field) = 6.8:1

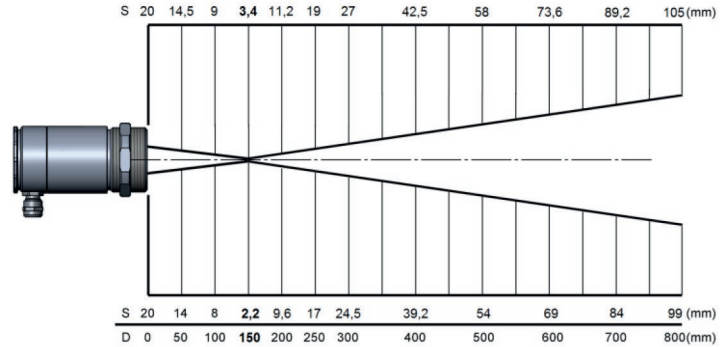

**GL / CTLC-4 / CTLC-2 /
CTLC-6**

Optics: CF3
 D:S (Focus distance) = 45:1
 4.5 mm @ 200 mm
 D:S (Far field) = 8:1

GH

Optics: CF3
 D:S (Focus distance) = 70:1
 2.9 mm @ 200 mm
 D:S (Far field) = 9.2:1

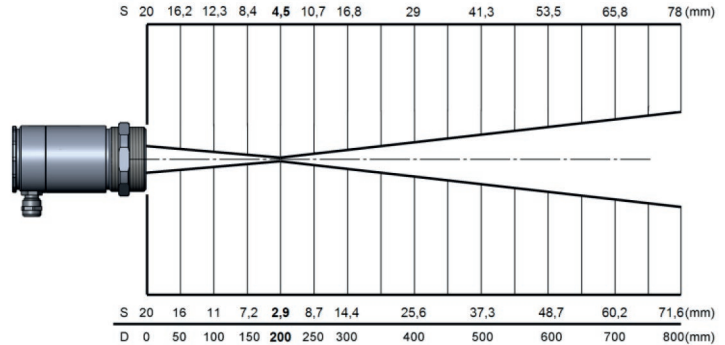

**GL / CTLC-4 / CTLC-2 /
CTLC-6**

Optics: CF4
 D:S (Focus distance) = 45:1
 10 mm @ 450 mm
 D:S (Far field) = 15:1

GH

Optics: CF4
 D:S (Focus distance) = 70:1
 6,5 mm @ 450 mm
 D:S (Far field) = 17.7:1

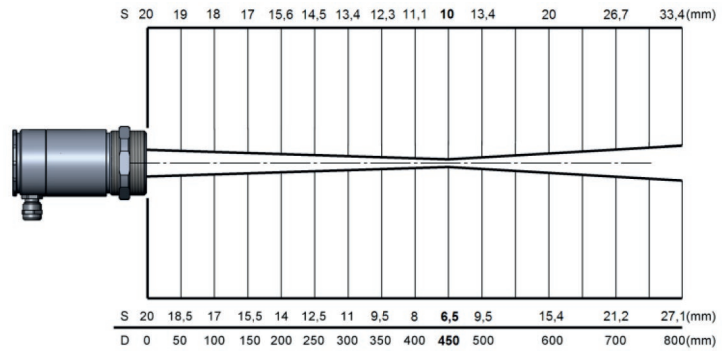

6. Mechanical Installation

6.1 Sensor

i Keep the optical path free of any obstacles. For an exact alignment of the sensor to the object activate the integrated double laser, [see 9.4](#).

The CTL is equipped with a metric M48x1.5 thread and can be installed either directly via the sensor thread or with help of the supplied mounting nut (standard) and fixed mounting bracket (standard) to a mounting device available.

NOTICE

Avoid mechanical violence on the sensor.

> Destruction of the system

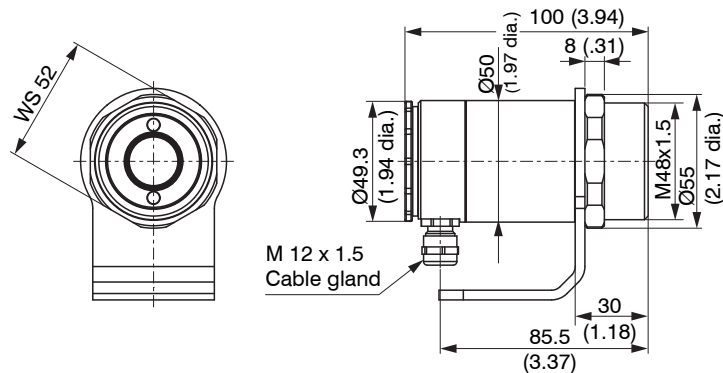

Fig. 3 Dimensions CTL sensor

Dimensions in mm, not to scale

Make sure to keep the optical path clear of any objects.

> Deviation of measured value, inaccurate measurement result

➡ For an exact alignment of the head to the object, please activate the integrated double laser, [see 9.4](#).

6.2 Controller

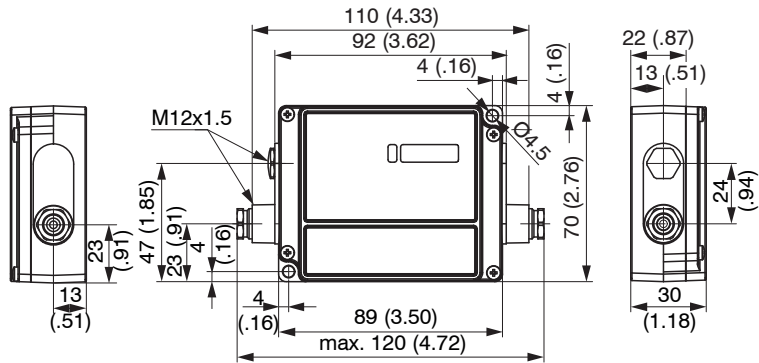

Fig. 4 Dimensions CTL controller

Dimensions in mm, not to scale

6.3 Mounting Bracket

The mounting bracket is included in delivery, [see 4.1](#).

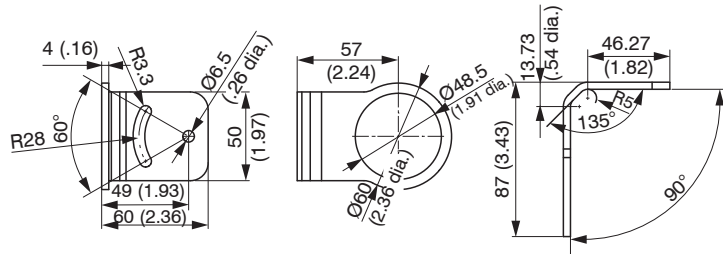

Fig. 5 Dimensions mounting bracket, fixed

Dimensions in mm, not to scale

The adjustable mounting bracket allows an adjustment of the sensor in two axis.

7. Electrical Installation

7.1 Cable Connections

7.1.1 Basic Version

The basic version is supplied with a sensor cable (connection sensor - controller).

➡ For the electrical installation of the CTL please open at first the cover of the controller (4 screws).

Below the display are the screw terminals for the cable connection.



7.1.2 Connector Version

This version has a connector plug integrated in the sensor backplane.

i Please use the original ready-made, fitting sensor cables which are optionally available, [see A 1](#).

Please note the pin assignment of the connector, [see Fig. 6](#).

i When using a cooling jacket the connector version is needed.

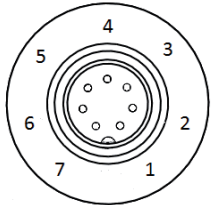

Pin assignment of connector plug (connector version only)			
Pin	Designation	Color (original sensor cable)	
1	Detector signal (+)	yellow	
2	Temperature sensor	brown	
3	Temperature sensor	white	
4	Detector signal (-)	green	
5	Ground laser (-)	grey	
6	Power supply laser (+)	pink	
7	-	not used	

Connector plug (outer view)

Fig. 6 Pin assignment of connector plug (connector version only)

Designation (Models CTL/ CTF/ CTLC/ CTLG)	
+8 ... 36 VDC	Power supply
GND	Ground (0 V) of power supply
GND	Ground (0 V) of internal inputs and outputs
OUT-AMB	Analog output sensor temperature (mV)
OUT-TC	Analog output thermocouple (J or K)
OUT-mV/mA	Analog output object temperature (mV or mA)
F1-F3	Functional inputs
AL2	Alarm 2 (open-collector output)
3V SW	PINK/ Power supply laser (+)
GND	GREY/ Power supply laser (-)
BROWN	Temperature probe sensor (NTC)
WHITE	Ground sensor
GREEN	Power supply sensor
YELLOW	Detector signal

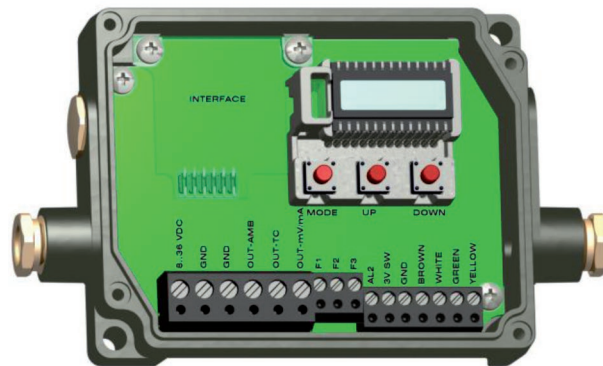

Fig. 7 Opened controller CTL/ CTF/ CTLC/ CTLG with terminal connections

Designation (Models CTLM)	
+8 ... 36 VDC	Power supply
GND	Ground (0 V) of power supply
GND	Ground (0 V) of internal inputs and outputs
AL2	Alarm 2 (open-collector output)
OUT-TC	Analog output thermocouple (J or K)
OUT-mV/mA	Analog output object temperature (mV or mA)
F1-F3	Functional inputs
GND	Ground (0 V)
3 V SW	PINK/ Power supply laser (+)
GND	GREY/ Power supply laser (-)
BROWN	Temperature sensor (NTC)
WHITE	Sensor ground
GREEN	Sensor power sensor
YELLOW	Detector signal

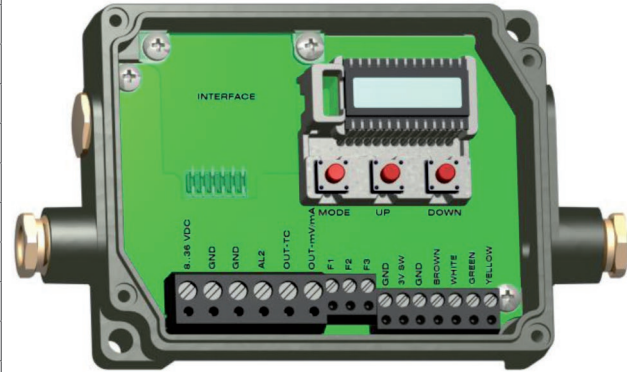

Fig. 8 Opened controller CTLM with terminal connections

7.2 Power Supply

i Please use a power supply unit with an output voltage of 8 - 36 VDC that provides at least 160 mA current. Residual ripple should be no more than 200 mV.

NOTICE

Never apply voltage to the analog outputs.

> Destruction of the output

The CTL is not a 2-wire sensor.

7.3 Cable Assembling

The cable gland M12x1.5 allows the use of cables with a diameter of 3 to 5 mm.

- Remove the isolation from the cable (40 mm power supply, 50 mm signal outputs, 60 mm functional inputs).
- Cut the shield down to approximately 5 mm and spread the strands out.
- Extract about 4 mm of the wire isolation and tin the wire ends.
- Place the pressing screw, the rubber washer and the metal washers of the cable gland one after the other onto the prepared cable end, [see Fig. 9](#).
- Spread the strands and fix the shield between two of the metal washers.
- Insert the cable into the cable gland until the limit stop.
- Screw the cap tight.

Every single wire may be connected to the according screw clamps according to their colors.

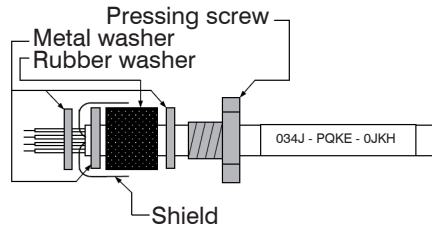

Fig. 9 Cable Assembling

- Use shielded cables only.
- The sensor shield has to be grounded.

7.4 Ground Connection

7.4.1 CTLM-5, CTLM-1, CTLM-2, CTLM-3L, CTLM-3H, CTLM-3H1 to -3H3 Models

At the bottom side of the main board PCB you will find a connector (jumper), which has been placed from factory side as shown in the picture (lower and middle pin connected), see Fig. 10. In this position the ground connections (GND power supply/ outputs) are connected with the ground of the controller housing.

To avoid ground loops and related signal interferences in industrial environments it might be necessary to interrupt this connection.

➡ Remove the board by loosening the two screws in order to switch the jumper on the back of the board.

➡ To do this, please put the jumper in the other position (middle and upper pin connected), see Fig. 11.

i If the thermocouple output is used the connection GND – housing should be interrupted generally.

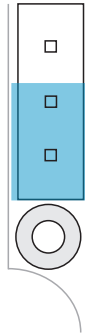

Fig. 10 Plug connector (jumper),
GND to housing; CTLM models

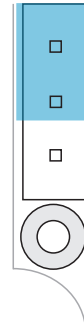

Fig. 11 Plug connector (jumper),
GND - open; CTLM models



Position
cable gland

7.4.2 CTL, CTLF, CTLC-4, CTLC-2, CTLC-6, CTLG Models

At the bottom side of the main board PCB you will find a connector (jumper), which has been placed from factory side as shown in the picture (left and middle pin connected), [see Fig. 12](#). In this position the ground connections (GND power supply/ outputs) are connected with the ground of the controller housing.

To avoid ground loops and related signal interferences in industrial environments it might be necessary to interrupt this connection.

➡ Remove the board by loosening the two screws in order to switch the jumper on the back of the board.

➡ To do this, please put the jumper in the other position (middle and right pin connected), [see Fig. 13](#).

i If the thermocouple output is used the connection GND – housing should be interrupted generally.

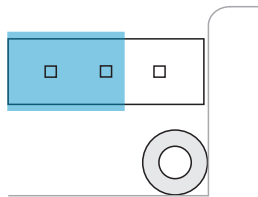

*Fig. 12 Plug connector (jumper),
GND to housing;
CTL, CTLF, CTLC, CTLG models*

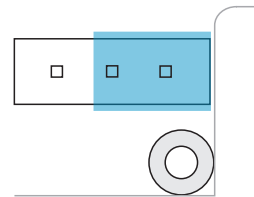

*Fig. 13 Plug connector (jumper),
GND - open;
CTL, CTLF, CTLC, CTLG models*



Position
cable
gland

7.5 Exchange of the Sensor

- After exchanging a head the calibration code of the new sensor must be entered into the controller.
 - After modification of the code a reset is necessary to activate the changes, [see 9](#).
- The calibration code is fixed on a label on the sensor. Do not remove this label or note the code. The code is needed if the controller must be exchanged.

From factory side the sensor has already been connected to the controller. Inside a certain model group an exchange of sensors and controllers is possible.

7.5.1 Entering of the Calibration Code

Every sensor has a specific calibration code, that is clearly printed on a label on the sensor, [see Fig. 14](#).



Fig. 14 Calibration code







- **i** Please do not remove this label or make sure the code is noted anywhere. The code is needed if the sensor has to be exchanged.

Every sensor has a specific calibration code, which is printed on the sensor. For a correct temperature measurement and functionality of the sensor this calibration code must be stored into the controller.

The calibration code consists of five blocks with 4 characters each.

Example:	EKJ0 -	00UD -	0A1B	A17U	93OZ
	block 1	block 2	block 3	block 4	block 5

- **i** After exchanging a sensor the calibration code of the new sensor must be entered into the controller.

For entering the code, please press the  and  -Taste (keep pressed) and then the  key, [see Fig. 30](#). The display shows `HCODE` and then the 4 signs of the first block. With  and  each sign can be changed.  switches to the next sign or next block.

7.5.2 Exchange of the Sensor Cable

The sensor cable can also be exchanged if necessary.

- ➡ For a dismantling on the sensor side, please open at first the cover plate on the back side of the sensor.
 - ➡ Then please remove the terminal block and loose the connections.
 - ➡ After the new cable has been installed, please do the same steps in reverse order.
- **i** Please take care the cable shield is properly connected to the sensor housing.

- **i** As exchange cable a cable type with same wire profiles and specification should be used to avoid influences on the accuracy.



Fig. 15 View on terminal block with sensor cables

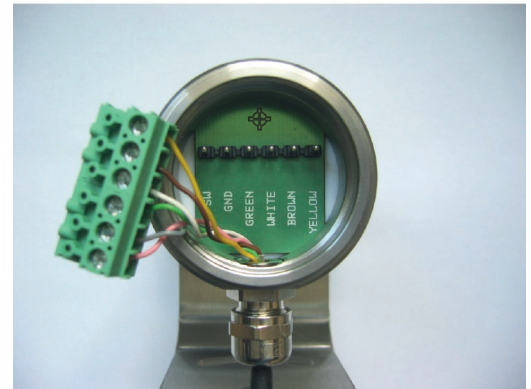

8. Outputs and Inputs

8.1 Analog Outputs

The thermoMETER CTL has two analog output channels.

8.1.1 Output Channel 1

This output is used for the object temperature. The selection of the output signal can be done via the programming keys, [see 9](#). The software allows the programming of output channel 1 as an alarm output.

Output signal	Range	Connection pin on CTL board
Voltage	0 ... 5 V	OUT-mV/mA
Voltage	0 ... 10 V	OUT-mV/mA
Current	0 ... 20 mA	OUT-mV/mA
Current	4 ... 20 mA	OUT-mV/mA
Thermo couple	TC J	OUT-TC
Thermo couple	TC K	OUT-TC

•
i According to the chosen output signal there are different connection pins on the main board (OUT-mV/mA or OUT-TC).

8.1.2 Output Channel 2 [only for CTL, CTLG]

The connection pin OUT AMB is used for output of the sensor temperature [-20 - 180 °C as 0 - 5 V or 0 - 10 V signal]. The software allows the programming of output channel 2 as an alarm output.

Instead of the sensor temperature THead also the object temperature TObj or controller temperature TBox can be selected as alarm source.

8.2 Digital Interfaces

All CTL sensors can be optionally equipped with an USB-, RS232-, RS485-, CAN Bus-, Profibus DP- or Ethernet-interface.

In the case that you want to use the delivered cable gland M12x1.5 for the interface cable, please disassemble the terminal block and assemble them again.

- ➡ To install, first remove the housing cover to get access to the interior of the housing.
- ➡ Now take the particular interface board and insert it into the slot provided in the controller.

The slot is located on the left side of the display, [see Fig. 16](#).

In the correct position the holes of the interface match with the thread holes of the controller.

- ➡ Now press the interface board down gently to connect it and use both M3x5 screws for fixing it in the controller housing.
- ➡ Plug the pre-assembled interface cable with the terminal block into the male connector of the interface board.

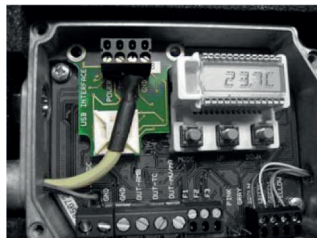

Fig. 16 Interface board

- ➡ Exchange the blind screw on the controller by the cable gland of the respective interface and install the appropriate interface cable.
- i** Please also pay attention to the additional notes for installing the respective interfaces, [see 8.2.1](#), [see 8.2.2](#) and the following interface chapters.

8.2.1 USB Interface

8.2.1.1 Installation

➡ Mount the USB adapter, [see 8.2](#).

•
1 Make sure the wiring is correct according to the wire colors printed on the interface board.

For industrial installations it is recommended to connect the shield of the USB adapter cable with the controller housing (inside the cable gland).

The CTL does not need external power supply for operation – it will be powered by the USB interface.

If an external power supply has already been installed, this will not affect the functionality of the CTL.

8.2.1.2 Driver Installation of Interface

➡ Please install the CompactConnect software, [see 11](#).

➡ Now please press the button `Install Adapter driver`.

All necessary device drivers will be installed. After connecting new sensors or new USB adapter cables to your PC the system will automatically allocate them to the correct driver. If the `Found New Hardware Wizard` appears you can select `Connect to Windows Update` or `Install the Software automatically`.

After you have connected the USB-cable to your PC and started the CompactConnect software the communication will be established. If the recognition is not automatic, you will find the drivers on the Compact Connect Software CD in the path `\Driver \ Infrared Sensor Adapter`.

8.2.2 RS232 Interface

8.2.2.1 Installation

➡ Mount the RS232 adapter, [see 8.2.](#)

• **i** Make sure the wiring is correct according to the drawing and designation printed on the interface board, [see Fig. 17.](#)

The CTL always needs an external power supply for operation.

8.2.2.2 Software Installation

➡ Please install the CompactConnect software, [see 11.](#)

➡ Follow the software instruction manual on the delivered CompactConnect software CD.

After you have connected the RS232 cable to your PC and started the CompactConnect software the communication will be established.

The setting for baud rate in the CompactConnect software must be the same as on the thermoMETER CTL unit (factory default: 9.6 kBaud).

• **i** Please make sure that the option `Scan non-USB devices` in menu `Preferences/Options` is activated in the CompactConnect software.

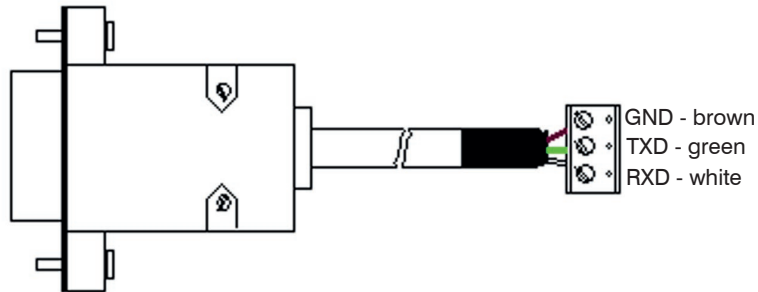

Fig. 17 Pin assignment RS232

8.2.3 RS485 Interface

8.2.3.1 Installation

➡ Mount the RS485 adapter, [see 8.2](#).

The RS485-USB adapter is providing a 2-wire half-duplex mode.

➡ Please connect terminal A of the interface with terminal A of the next RS485 interface and so on, [see Fig. 18](#). With the B terminal proceed as well.

i Make sure that you always connect A to A and B to B, not reverse.

You may run up to 32 CTL units on one RS485-USB adapter.

➡ Turn the 120R-switch to ON only at one of the connected CTL units.

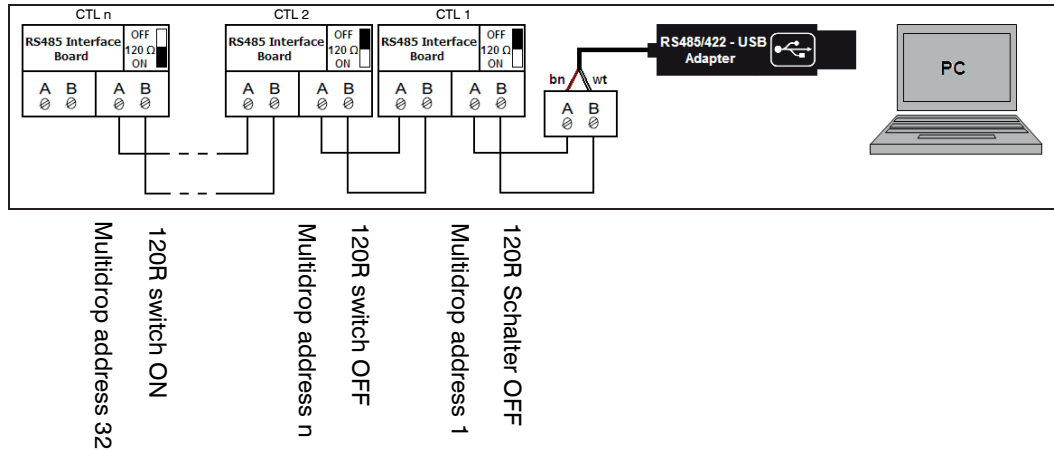

Fig. 18 Pin assignment RS485

8.2.3.2 Sensor Installation

Each CTL unit connected to the RS485 needs a different multidrop address (1 ... 32).

➡ Please adjust the address by pressing the  button until M xx appears in the display.

Using the Up and Down keys you can change the shown address (xx) The address can also be changed with the CompactConnect software. The baud rate setting in the CompactConnect software must be the same as on the CT unit (factory default: 9.6 kBaud.)

➡ Please install the CompactConnect software, [see 11](#).

➡ Please connect the RS485 USB adapter (TM-RS485USBK-CT) via the supplied USB cable with your PC.

After it has been connected the computer will recognize a new USB device and (if connected the first time) will ask for installation of the according driver software.

➡ Please select `Search` and install the RS485 adapter USB driver from the CompactConnect software CD.

8.2.4 Profibus Interface

8.2.4.1 Installation

➡ Mount the Profibus adapter, [see 8.2.](#)

i Make sure the wiring is correct, [see Fig. 19.](#)

i We recommend for industrial installations to connect the shield of the Profibus cable with the controller housing (inside the cable gland).

The thermoMETER CTL always needs an external power supply.

Connector	Color	Function	Pin
A	Green	A	2
B	Red	B	4
GND	Blue	Ground	3
VCC	Brown	+5 V (not used)	1
Shield	n.c.		5
Housing	Silver (shield)		

Fig. 19 Pin assignment Profibus interface

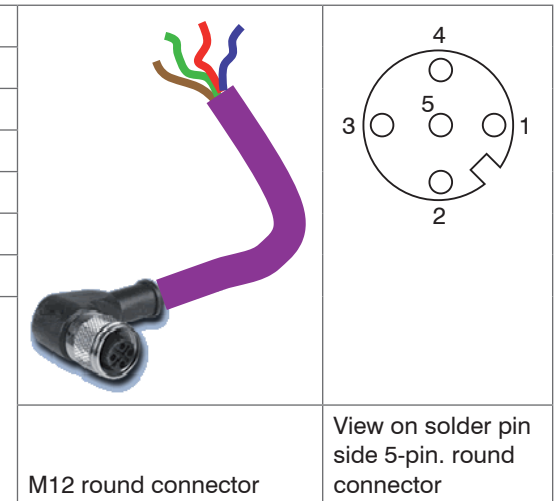

8.2.4.2 Commissioning Profibus

- Read in the „IT010A90.gsd“ GSD file, contained on the delivered CompactConnect software CD, into the PLC configuration tool and configure the controller.

At least one module must be selected. You will find more information about the Profibus interface on the enclosed CompactConnect software CD, page 18.

- Open the controller and connect the power supply, see Fig. 20.

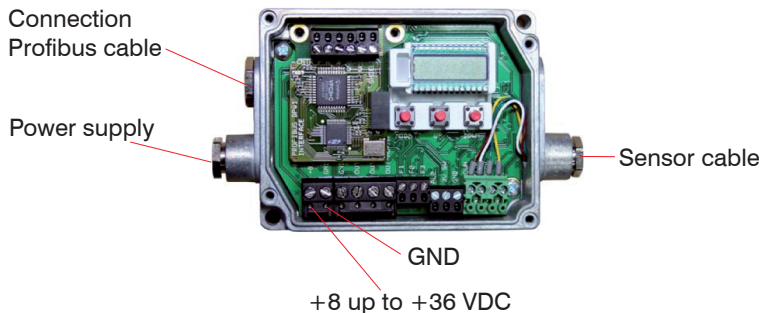

Fig. 20 Commissioning Profibus

- Switch on the power supply.
- Press the Mode button 18 times until the item „SL001“ appears. Set the slave address with the UP and DOWN buttons. Valid slave addresses start with 001 up to 125. Use the same address as in the PLC configuration tool, see the Profibus instruction manual on page 4, 6 on CompactConnect Software CD.
- Switch off the controller for at least 3 seconds by interrupting the power supply.
- Connect the connector of the Profibus cable with a Profibus port. Take care on the terminating resistor of the Profibus.

The controller with DPv1 Profibus is now ready for data exchange with the Profibus master; see the Profibus instruction manual on page 7 on CompactConnect Software CD.

The measuring values are displayed in hex format and must be converted into decimals; see the Profibus instruction manual on page 7 on CompactConnect Software CD.

The settings of the DPv1 Profibus interface and the communication with the Profibus master are described in the Profibus instruction manual on CompactConnect Software CD.

8.2.5 CAN BUS Interface

➡ Mount the CAN BUS adapter, [see 8.2](#).

i Make sure the wiring is correct, [see Fig. 19](#).

i We recommend for industrial installations to connect the shield of the CAN BUS cable with the controller housing (inside the cable gland).

The thermoMETER CTL always needs an external power supply.

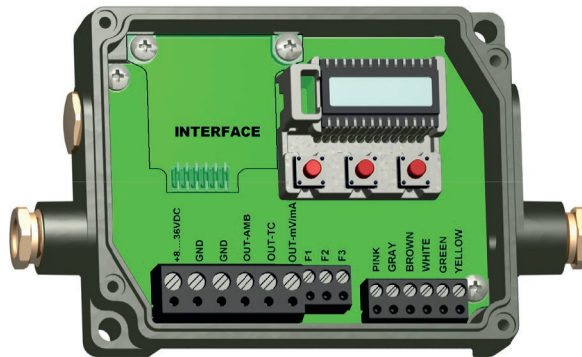

Fig. 21 View on CAN BUS interface

CAN Protocol

CAN open (see documentation on CompactConnect software CD)

Wiring

CAN Bus:

CAN_H on terminal „H“

CAN_L on terminal „L“

Analog signal:

Black cord on terminal „GND“

Red cord on terminal „OUT-mV“

The controller contains additional terminals to connect other devices (power supply, CAN bus, terminating resistor).

CAN module factory settings

Module address: 20 (14 H)

Baud rate: 250 kBaud

Analog input: 0 ... 10 V

Temperature range: 0 ... 60 °C (2 decimal places)

Emission ratio: 0.970

I The settings for “Analog output 0 ... 10 V“ and “Temperature range 0 ... 60 °C“ on the CTL sensor must be identical with the CAN bus module values.

Factory settings address and baud rate

CAN open service „LSS / Layer Setting Services“

Index temperature value:

The temperature information is located in the object register 7130h (Sub01):

e.g. B4: LB B5: HB

B4: DA B5: 07 T = 20.10 °C

Before delivery, MICRO-EPSILON can set parameters, desired by the customer, for an extra charge. For the subsequent conversion a CAN master is required.

Diagnosis

If the power supply is on, the LED displays one of the following conditions:

State	Meaning
Flashes quickly	Device is in preoperational-mode.
Off	Power supply is not correct / faulty hardware.
Illuminates	Device is in operational mode.
Sparkles	Device is stopped. = Communication stopped.

8.2.6 Modbus RTU

8.2.6.1 Serial Interface Parameters

Baud rate: 9600 or 19200, set by user (factory default: 9600)

Data bits: 8

Parity: even

Stop bits: 2

Flow control: off

8.2.6.2 Protocol

The protocol is a Modbus RTU protocol.

8.2.6.3 Installation Overview

- ➡ Insert the Modbus RTU interface on the CTL electronic board and power it with 8 - 36 V.
- ➡ Select the RS422 mode on the controller.

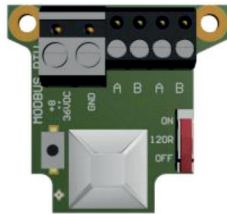

Fig. 22 Modbus RTU interface

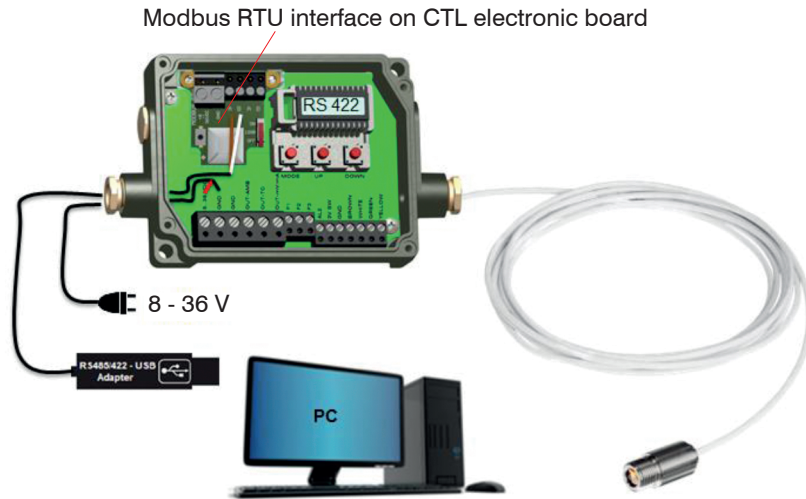

Fig. 23 Installation Modbus RTU interface on thermoMETER CTL electronic board

➡ Use a Modbus RTU program to read out the data, [see Fig. 24](#).

This is done via the Read Holding Registers and Read Input Registers, [see Fig. 25](#).

Connection type: Serial

Comm port: COM65

Parity: Even

Stop bits: Two

Baud rate: 9600

Byte size: 8

Mode: Rtu

Byte order: 4321

Fig. 24 View Modbus RTU program

- 03 Read Holding Registers
- 01 Read Coils
- 02 Read Discrete Inputs
- 03 Read Holding Registers
- 04 Read Input Registers
- 05 Write Single Coil
- 06 Write Single Register
- 08 Diagnostics
- 15 Write Multiple Coils
- 16 Write Holding Registers

Fig. 25 View dropdown menu Modbus RTU program

8.2.6.4 Connection of More than one Device (Synchronisation)

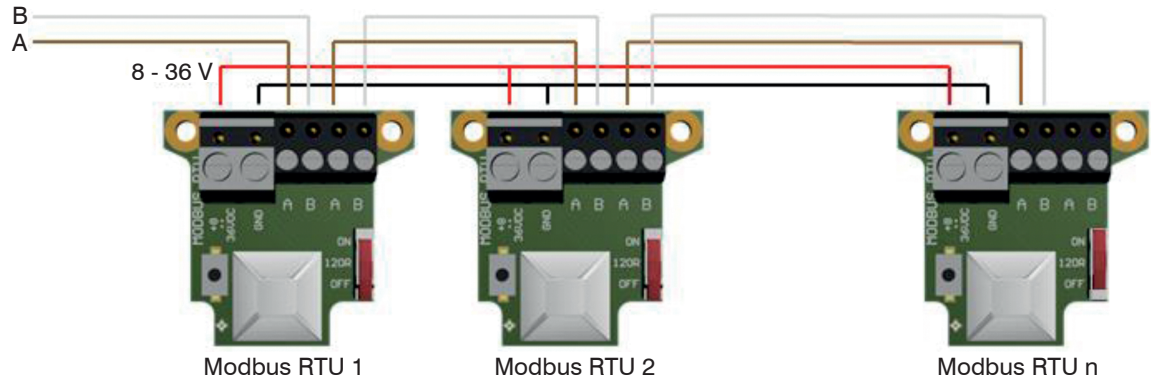

➡ Turn the 120R switch to ON for the last connected CTL unit.

i For the assignment of the Modbus ID of the individual devices, the devices must be connected one after the other.

By default the Modbus ID is for every device 1.

In order to communicate, each device needs its own ID. The numbers 1 to 247 can be selected.

8.2.6.5 Overview of Digital Commands for Modbus RTU Digital Interfaces for CT and CTLaser Sensors

The command overview is available online on the product side of the sensor at:

<https://www.micro-epsilon.de/download/manuals/man--thermoMETER-ct-ctlaser-modbus-rtu-commands--en.pdf>

8.2.7 Ethernet Interface

8.2.7.1 Installation

- ➡ Mount the Ethernet adapter, [see 8.2](#).
- ➡ In case you want to run the pre-mounted cable of the Ethernet box through the delivered cable gland, the terminal block has to be disassembled/assembled.

The thermoMETER CTL always requires an external power supply of at least 12 V.

•
i Make sure the wiring is correct according to the colors printed on the interface board.

- ➡ Please connect the shield of the cable with the controller housing (inside the cable gland).
- ➡ Please connect the Ethernet adapter device with your network using an Ethernet cable.

8.2.7.2 Installation of the Ethernet Adapter in a Network

- ➡ First connect the PC to the Internet.
- ➡ Please install the CompactConnect software CD, [see 11](#).

If the autorun option is activated the installation wizard will start automatically. Otherwise please start CDset-up.exe from the CompactConnect software CD. The following screen will appear, [see Fig. 26](#).

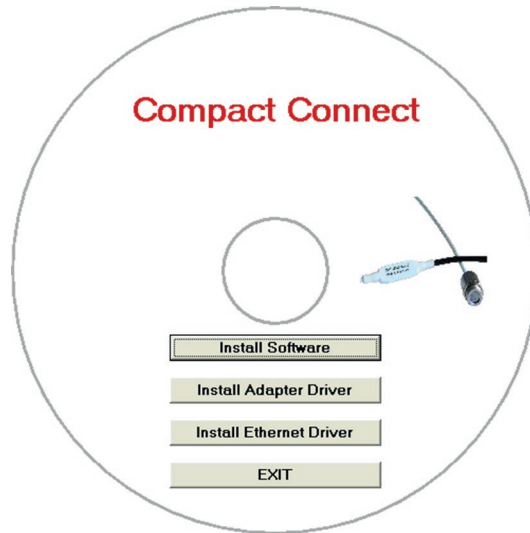
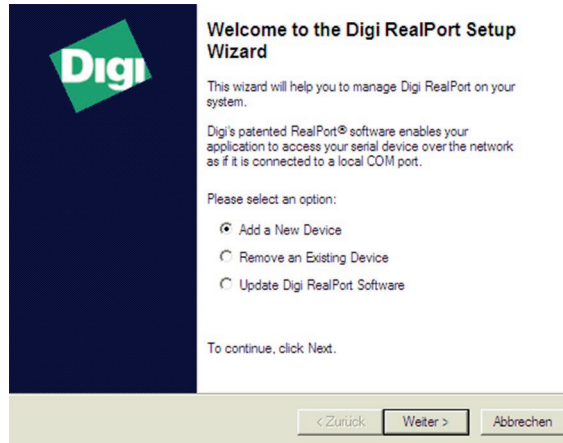

Fig. 26 View CompactConnect CD-ROM

- ➡ Now install the device driver by selecting `Install Ethernet Driver`.

8.2.7.3 Deinstallation of an Ethernet Interface in a Network



➡ Select Add New Device and press Weiter.

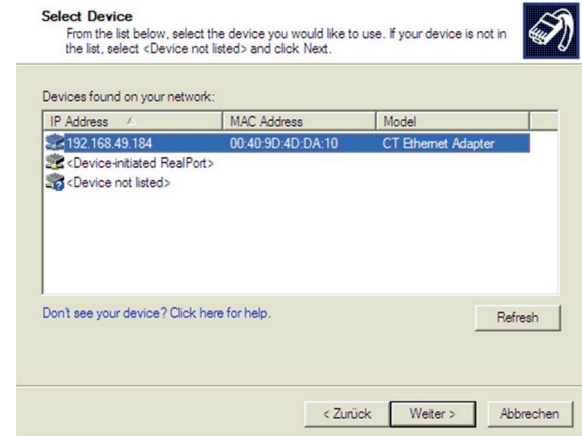

The IP and MAC address of the Ethernet adapter will appear in the list. You will find the MAC address also printed on the Ethernet adapter.

➡ Please mark the adapter in the list and press Weiter.

Describe the Device

Enter information for the device you would like to use.



Device Model Name:
CT Ethernet Adapter

Network Settings
 IP MAC DNS TCP-L
192 . 168 . 49 . 184

Default Network Profile:
TCP: Typical Settings

RealPort TCP: 771 Serial UDP: 2101

Wait for COM open request

COM Port Settings
No. Ports: 1
Starting COM: COM97

Skip Modem PnP

Device Features
 Encryption
 Authentication

Install Options...
Help

< Zurück Fertig stellen Abbrechen

The following screen shows all settings.

➡ Please press **Fertig stellen**.

Installing Digi RealPort

Please wait while your Digi RealPort device is installed.



Installing Multiport Serial device

Progress bar: 100% (10 blue segments)

< Zurück Fertig stellen Abbrechen

The device will be installed inside the network.

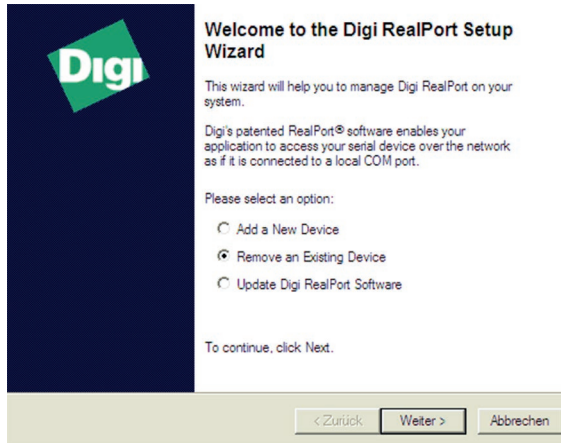

To deinstall an adapter please follow the steps described under Network Installation, [see 8.2.7.2.](#)
 ➡ Select Remove an Existing Device and press then Weiter.

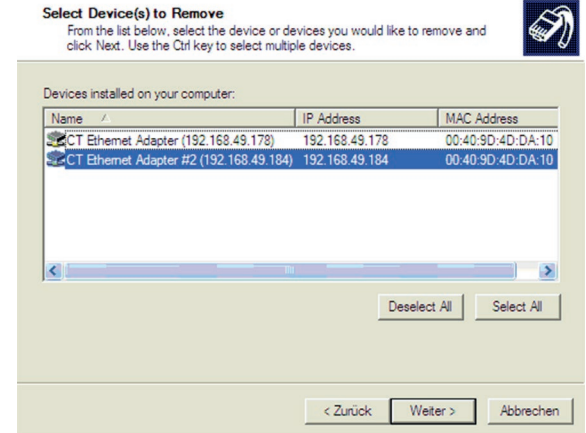

In the upper overview all on the PC installed Ethernet adapter are shown.
 ➡ Select the adapter(s) which should be deinstalled and press Weiter.

8.2.7.4 Direct Connection to a PC

If a direct connection between Ethernet adapter and PC is required both have to be connected via a cross-over cable. In addition the adapter and the PC need to get a fixed IP address.

➡ Please open the Windows device manager after the network installation (Start/Control panel/System/Hardware/Device manager).

➡ Please choose Mehrfachadapter/Multi adapter (serial) from the list.

By double clicking the desired Ethernet adapter, a properties window is opening.

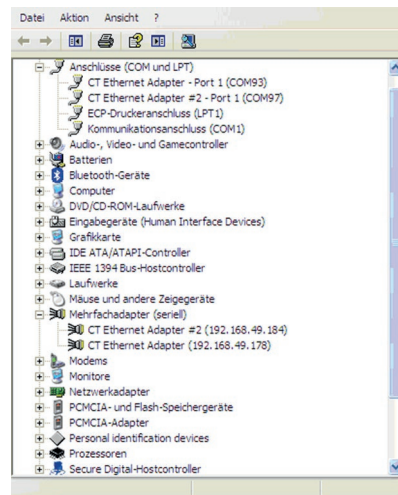

➡ Please open the tab Advanced in this window. Beside Device UI you will find a link with the network IP address.



By clicking on the link the configuration page for the Ethernet adapter will be opened in your web browser.

➡ Please select Network (Navigation left; below configuration).

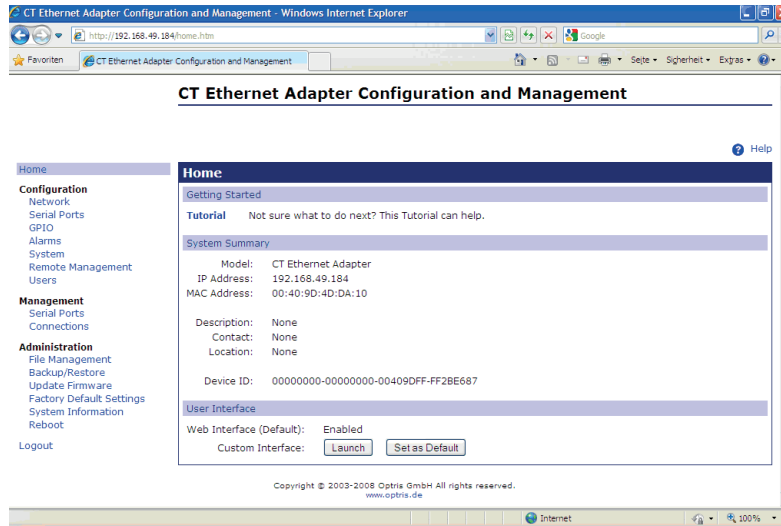

In the input mask Use the following IP address below you can now enter a fixed IP address.

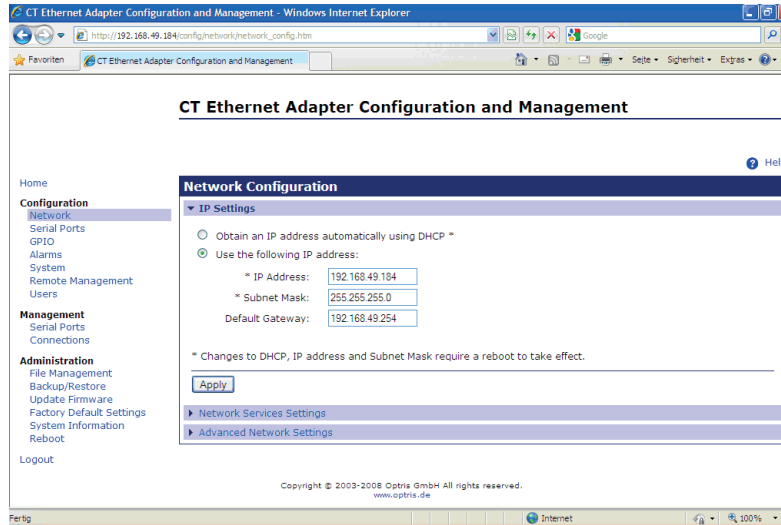

➡ Confirm your settings with **Apply**.

For a communication with the adapter you now have to configure the network settings on your PC.

➡ Please open the LAN settings (Start/Control panel/Network settings/Settings).

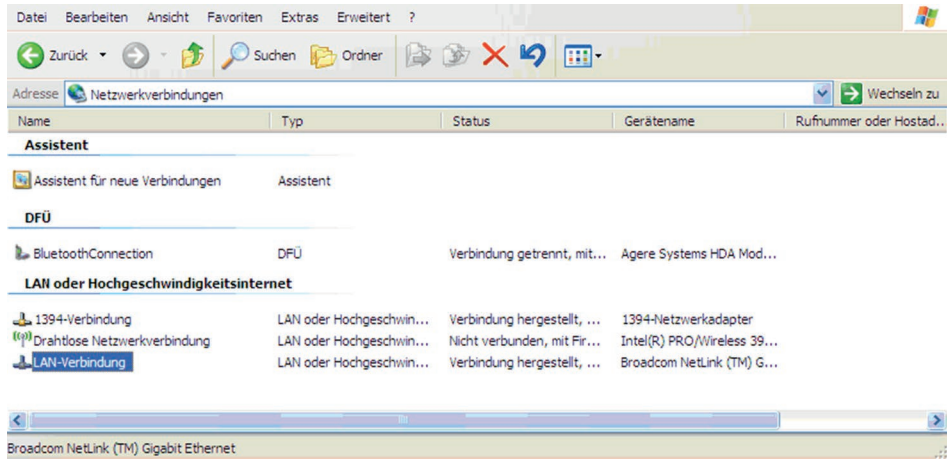

➡ Mark the LAN connection and open the properties window using the right mouse button.

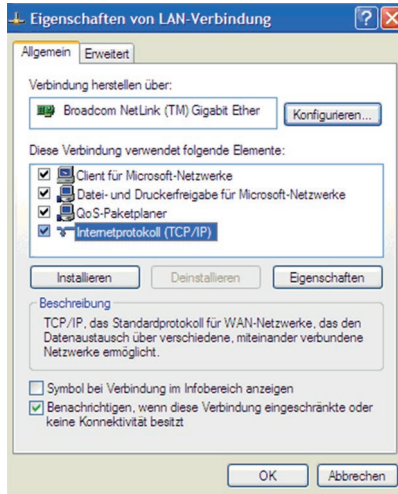

➔ Double click on Internetprotokoll/Internet protocol (TCP/IP).

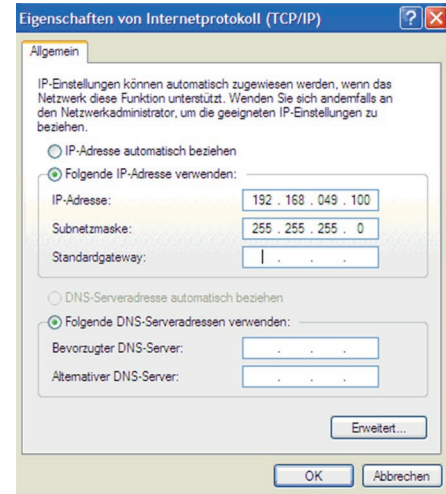

➔ Please enter here a fixed IP address for the PC.

i Please note that the first three blocks (example: 192.168.049) have to match with the IP address of the adapter device.

➔ Press OK.

The installation is finished.

8.2.7.5 Settings inside the CompactConnect Software

After a successful network installation of the Ethernet adapter you can start the CompactConnect software.

To make sure that an available device can be found you should first activate the function `Scan non-USB devices` in the menu point `Preferences/Options`:

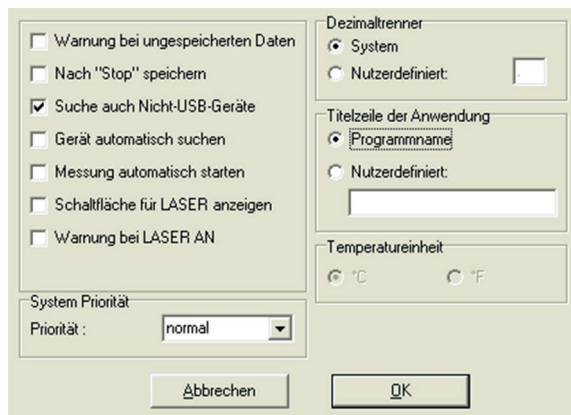

Furthermore you should set the `Communication mode` to `Standard` (menu: `Measurement/Settings`).

This activates the so called polling mode ¹ (bi-directional communication).

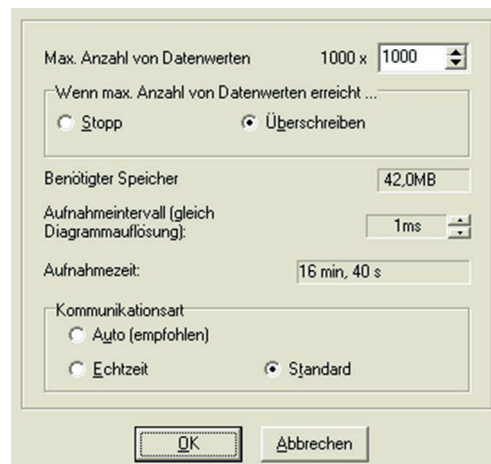

1) Polling Mode = Method, to determine the status of a device consisting of hardware or software or the event of a change of values by cyclic queries.

8.2.7.6 Resetting the Ethernet Adapter

The Ethernet adapter can be reset to the factory setting.

 Please use a ballpoint pen to press the reset button (hole at the top of the housing).

 Switch on the power supply while pressing the reset button.

After a few seconds you will see a flashing green LED (network connection).

 Please wait until the green LED flashes with a 1-5-1¹ pattern, then you can release the reset button.

 Wait until the adapter boots again.

The configuration is reset to factory setting during this time.

The configuration is not reset, if you switch off the adapter before you release the reset button.

The adapter will show an undefined configuration², if you switch off the adapter briefly after you have released the reset button.

The adapter works in the DHCP mode after resetting.

If you want to make a direct connection to a PC, [see 8.2.7.4](#).

1) Flashing - break - 5 x flashing - break - flashing

2) If necessary only some values are reset.

8.3 Relays Outputs

The thermoMETER CTL can optionally be equipped with a relay output. The relay board is installed the same way as the digital interfaces, [see 8.2](#).

➡ Connect the external electrical circuit with the terminal blocks.

A simultaneous installation of a digital interface and the relay outputs is not possible.

The relay board provides two fully isolated switches, which have the capability to switch max 60 VDC/42 VAC RMS, 0.4 A, DC/AC. A red LED shows the closed switch.

The switching thresholds correspondent with the values for alarm 1 and 2, [see 8.5](#) , [see 8.5.2](#) and are factory-set, [see A 2](#):

Alarm 1 = 30 °C/ norm. Closed (Low-Alarm) and Alarm 2 = 100 °C/ norm. open (High-Alarm).

The adjustment of the alarms can result from the modification of the alarm 1 and alarm 2 via the programming keys.

To make advanced settings (change of low- and high alarm) a digital interface (USB, RS232) and the CompactConnect software is needed.

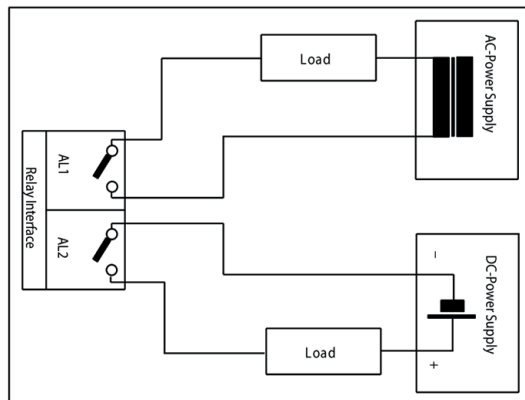

Fig. 27 Relay interface with pin assignment

8.4 Functional Inputs

The three functional inputs F1 - F3 can be programmed with the CompactConnect software, only.

F1 (digital)	Trigger (a 0 V - level on F1 resets the hold functions)
F2 (analog)	External emissivity adjustment [0 - 10 V: 0 V ► $\varepsilon = 0.1$; 9 V ► $\varepsilon = 1$; 10 V ► $\varepsilon = 1.1$]
F3 (analog)	External compensation of ambient temperature/the range is scalable via CompactConnect software [0 - 10 V: ► -40 - 900 °C/preset range: -20 - 200 °C]
F1 - F3 (digital)	Emissivity (digital choice via table) A non-connected input represents: F1 = High F2, F3 = Low High-level: $\geq +3 \text{ V} \dots +36 \text{ V}$ Low-level: $\leq +0.4 \text{ V} \dots -36 \text{ V}$

8.5 Alarms

The thermoMETER CTL has following alarm features:

All alarms (alarm 1, alarm 2, output channel 1 and 2 if used as alarm output) have a fixed hysteresis of 2 K).

8.5.1 Output Channel 1 and 2 (Channel 2 on CTL, CTLG)

The respective output channel has to be switched into digital mode for activation. For this the CompactConnect software is required.

8.5.2 Visual Alarms

These alarms will cause a change of color of the LCD display and will also change the status of the optional relays interface. In addition, Alarm 2 can be used as open collector output at pin AL2 on the controller (24 V/ 50 mA).

The alarms are factory-set as follows:

Alarm 1	Norm. closed/Low-Alarm
Alarm 2	Norm. open/High-Alarm

Both of these alarms will have effect on the LCD color:

BLUE	Alarm 1 active
RED	Alarm 2 active
GREEN	No alarm active

For extended setup like definition as low or high alarm (via change of normally open/closed), selection of the signal source (TObj, THead, TBox) a digital interface (e.g. USB, RS232) including the CompactConnect software is needed.

8.5.3 Open-collector Output / AL2

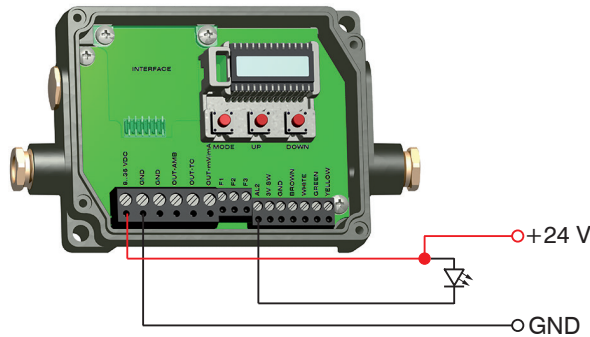

Fig. 28 Open-collector output / AL2

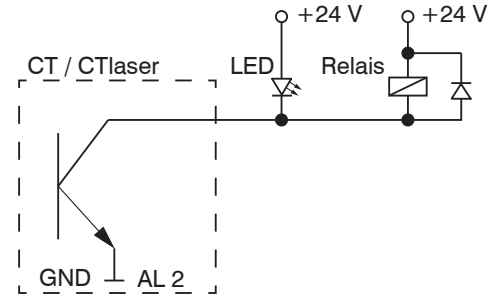

Fig. 29 Open-collector output / AL2 switching diagrams

- The transistor acts as switch. In case of an alarm, the contact is closed.
Always one load unit (relay, LED or a resistor) must be connected.
The alarm voltage (here 24 V) must not be connected directly to the alarm output (short circuit).

NOTICE

Prevent the load from exceeding a maximum of 50 mA on the output.
> Destruction of the output

9. Operation

After power up the unit the sensor starts an initializing routine for some seconds. During this time the display will show `INIT`. After this procedure the object temperature is shown in the display. The display backlight color changes according to the alarm settings, [see 8.5](#), [see 8.5.2](#).

Pressing the Mode button again recalls the last called function on the display. The signal processing features Peak hold and Valley hold cannot be selected simultaneously.

9.1 Sensor Settings

i To set the CTlaser back to the factory default settings, press at first the `Down`-key and then the `Mode`-key and keep both pressed for approx. 3 seconds. `RESET` appears as confirmation in the display.

The programming keys `○`, `^` and `∇` enable the user to set the sensor on-site. The current measuring value or the chosen feature is displayed. With `Mode` the operator obtains the chosen feature, with `^` and `∇` the functional parameters can be selected – a change of parameters will have immediate effect. If no key is pressed for more than 10 seconds the display automatically shows the calculated object temperature (according to the signal processing).

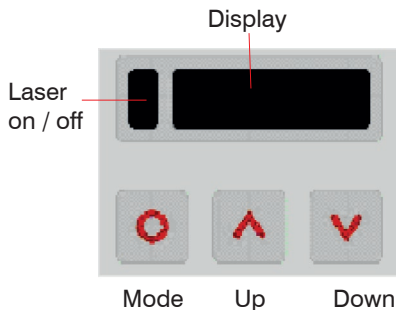











Fig. 30 Display and programming keys

Display	Mode [Sample]	Adjustment Range
S ON	Laser sighting [On]	ON/ OFF
142.3C	Object temperature (after signal processing) [142.3 °C]	Fixed
127CH	Sensor temperature [127 °C]	Fixed
25CB	Box temperature [25 °C]	Fixed
142CA	Current object temperature	Fixed
<input type="checkbox"/> MV5	Signal output channel 1 [0 - 5 V]	<input type="checkbox"/> 0 - 20 = 0 - 20 mA/ <input type="checkbox"/> 4 - 20 = 4 - 20 mA/ <input type="checkbox"/> MV5 = 0 - 5 V/ <input type="checkbox"/> MV10 = 0 - 10 V/ <input type="checkbox"/> TCJ = Thermocouple type J/ <input type="checkbox"/> TCK = Thermocouple type K
E0.970	Emissivity [0.970]	0.100 ... 1.100
T1.000	Transmission [1,000]	0.100 ... 1.100
A 0.2	Signal output Average [0.2 s]	A---- = inactive/0.1 ... 999.9 s
P----	Signal output Peak hold [inactive]	P---- = inactive/0.1 ... 999.9 s/P oo oo oo oo = infinite
V----	Signal output Valley hold [inactive]	V---- = inactive/0.1 ... 999.9 s/V ∞ = infinite
u 0.0	Lower limit temperature range [0 °C]	depending on model/ inactive at TCJ- and TCK-output
n 500.0	Upper limit temperature range [500 °C]	depending on model/ inactive at TCJ- and TCK-output
[0.00	Lower limit signal output [0 V]	According to the range of the selected output signal

Display	Mode [Sample]	Adjustment Range
] 5.00	Upper limit signal output [0 V]	According to the range of the selected output signal
U °C	Temperature unit [°C]	°C/°F
/ 30.0	Lower alarm limit [30 °C]	depending on model
// 100.0	Upper alarm limit [100 °C]	depending on model
XHEAD	Ambient temperature compensation [Sensor temperature]	XHEAD = sensor temperature/ -40.0 ... 900.0 °C (for CTL) as fixed value for compensation/ returning to XHEAD (sensor temperature) by pressing  and  together
M 01	Multidrop address [1] (only with RS485 interface) (only with RS422 Interface)	01 ... 32
B 9.6	Baud rate in kBaud [9.6]	9.6/19.2/38.4/57.6/115.2 kBaud

9.2 Explanation to the Menu Items

Display	Description
S ON	Activating (ON) and Deactivating (OFF) of the Sighting Laser. By pressing  or  the laser can be switched on and off.
 MV5	Selection of the output signal. By pressing  or  the different output signals can be selected, see 9.1 .
EO.970	Setup of emissivity. Pressing  increases the value;  decreases the value (also valid for all further functions). The emissivity (ϵ - Epsilon) is a material constant factor to describe the ability of the body to emit infrared energy, see 14 .
T1.000	Setup of transmissivity. This function is used if an optical component (protective window, additional optics e.g.) is mounted between sensor and object. The standard setting is 1.000 = 100 % (if no protective window etc. is used).
A 0.2	Setup of Average time. If the value is set to 0.0 the display will show --- (function deactivated). In this mode an arithmetic algorithm will be performed to smoothen the signal. The set time is the time constant. This function can be combined with all other post processing functions.
P---	Setup of Peak hold. If the value is set to 0.0 the display will show --- (function deactivated). In this mode the sensor is waiting for descending signals. If the signal descends the algorithm maintains the previous signal peak for the specified time. After the hold time the signal will drop down to the second highest value or will descend by 1/8 of the difference between the previous peak and the minimum value during the hold time. This value will be held again for the specified time. After this the signal will drop down with slow time constant and will follow the current object temperature.
V---	Setup of Valley hold. If the value is set to 0.0 the display will show --- (function deactivated). In this mode the sensor waits for ascending signals. The definition of the algorithm is according to the peak hold algorithm (inverted).

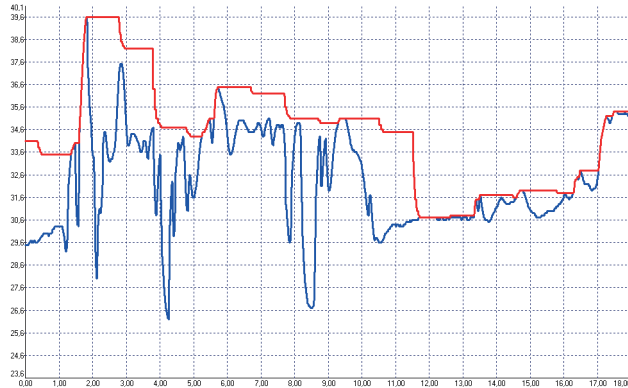



Fig. 31 Signal graph with P---

Red graph: TProcess with Peak Hold (Hold time = 1 s)

Blue graph: TActual without post processing

Display	Description
u 0.0	Setup of the lower limit of temperature range. The minimum difference between lower and upper limit is 20 K. If you set the lower limit to a value \geq upper limit, the upper limit will be adjusted to [lower limit + 20 K] automatically.
n 500.0	Setup of the upper limit of the temperature range. The minimum difference between upper and lower limit is 20 K. The upper limit can only be set to a value = lower limit + 20 K.
[0.00	Setup of the lower limit of the signal output. This setting allows an assignment of a certain signal output level to the lower limit of the temperature range. The adjustment range corresponds to the selected output mode (e.g. 0 - 5 V).

Display	Description
] 5.00	Setup of the upper limit of the signal output. This setting allows an assignment of a certain signal output level to the upper limit of the temperature range. The adjustment range corresponds to the selected output mode (e.g. 0 - 5 V).
U °C	Setup of the temperature unit [°C or °F]
/ 30.0	Setup of the lower alarm limit. This value corresponds to alarm 1, see 8.5 , see 8.5.2 . and is also used as threshold value for relay 1 (if the optional relay board is used).
// 100.0	Setup of the upper alarm limit. This value corresponds to alarm 2, see 8.5 , see 8.5.2 . and is also used as threshold value for relay 2 (if the optional relay board is used).
XHEAD	<p>Setup of the ambient temperature compensation. In dependence on the emissivity value of the object a certain amount of ambient radiation will be reflected from the object surface. To compensate this impact, this function allows the setup of a fixed value which represents the ambient radiation.</p> <p>i Especially if there is a big difference between the ambient temperature at the object and the sensor temperature the use of ambient temperature compensation is recommended.</p> <p>If XHEAD is shown the ambient temperature value will be taken from the sensor-internal probe. To return to XHEAD, please press  and  together.</p>
M 01	Setup of the Multidrop address. In a RS485 network each sensor will need a specific address. This menu item will only be shown if a RS485 interface board is plugged in.
B 9.6	Setup of the baud rate for digital data transfer

9.3 Digital Command Set

The digital communication of the CTL sensors is based on a binary protocol.

You will find a protocol and command description on the software CD in the directory: \Commands.

VORSICHT

Laser radiation.

Irritation or injury of the eyes possible. Close your eyes or immediately turn away if the laser beam hits the eye.

Do not stare into the laser beam. Avoid indirect exposure via reflective surfaces!

NOTICE

9.4 Laser Sighting

The thermoMETER CTL operate with a double laser sighting which should support the sensor alignment. The measurement spot is within the two laser points.

In the focal point of the respective lens, [see 5](#), both laser points overlap each other and therefore mark the minimum measurement spot as one laser point. This is how the sensor can be positioned for the object to be measured.

The laser can be activated/ deactivated via the programming keys on the unit or via the software. If the laser is activated a yellow LED will shine (beside temperature display), [see Fig. 29](#). At ambient temperatures > 50 °C the laser will switch off automatically.

i The two laser points mark the position of the measuring spot, but not its exact size. The exact size of the measurement spot can be found in the optical charts, [see 5](#).

i At ambient temperatures > 50 °C the laser will be switched off automatically.

The laser should only be used for sighting and positioning of the sensor, not for permanent use.

- > Shorten the lifetime of the sensor diodes
- > Inaccurate or incorrect measurements

9.5 Error Messages

The display of the thermoMETER CTL can show the following error messages:

9.5.1 CTL, CTLF, CTLC-4, CTLC-2, CTLC-6, CTLG Models

- OVER Object temperature too high
- UNDER Object temperature too low
- ^ ^ ^ CH Sensor temperature too high
- vvCH Sensor temperature too high

9.5.2 CTLM-5, CTLM-1, CTLM-2, CTLM-3L, CTLM-3H, CTLM-3H1 bis -3H3 Models

1. digit:

- 0x No error
- 1x Sensor temperature probe short circuit to GND
- 2x Box temperature too low
- 4x Box temperature too high
- 6x Box temperature probe disconnected
- 8x Box temperature probe short circuit to GND

2. digit:

- 0x No error
- x2 Object temperature to high
- x4 Sensor temperature too low
- x8 Sensor temperature too high
- xC Sensor temperature probe disconnected

10. Instructions for Operation

10.1 Cleaning

Lens cleaning: Blow off loose particles using clean compressed air. The lens surface can be cleaned with a soft, humid tissue moistened with water or a lens cleaner (e.g. Purosol or B + W Lens Cleaner).

NOTICE

Never use cleaning compounds which contain solvents (neither for the lens nor for the housing).
> Destruction of the sensor and/or the controller

11. CompactConnect Software

➡ Insert the CompactConnect installation CD into the according drive on your computer.

If the auto run option is activated the installation wizard will start automatically.

Otherwise, please start CDsetup.exe from the CD-ROM.

➡ Follow the instructions of the wizard until the installation is finished.

The installation wizard will place a launch icon on the desktop and in the start menu.

If you want to uninstall the CompactConnect software from your system, please use the `uninstall` icon in the start menu.

You will find detailed software manual on the CompactConnect software CD.

11.1 System Requirements

- Windows XP, Windows Vista, Windows 7, 8 and 10
- At least 128 MByte RAM
- USB Interface
- CD-ROM drive
- Hard disc with at least 30 MByte free space

11.2 Main Features

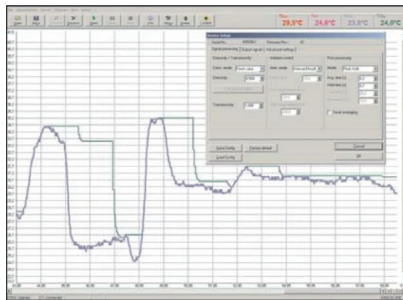

Fig. 32 Graphic display main features

- Graphical display for temperature measuring values and automatic data logging for analysis and documentation
- Complete sensor setup and remote controlling
- Adjustment of signal processing functions
- Programming of outputs and functional inputs

12. Communication Settings

12.1 Serial Interface

Baud rate: 9.6 ... 115.2 kBaud (adjustable on the unit or via software)
Data bits: 8
Parity: none
Stop bits: 1
Flow control: off

12.2 Protocol

All sensors of the CTlaser series are using a binary protocol. Alternatively they can be switched to an ASCII protocol. To get a fast communication the protocol has no additional overhead with CR, LR or ACK bytes.

12.3 ASCII Protocol

To switch to the ASCII protocol please use the following command:

Decimal: 131
HEX: 0x83
Data, answer: byte 1
Result: 0 – Binary protocol
1 – ASCII protocol

12.4 Saving of Parameter Settings

After power on of the CTlaser sensor the flash mode is active. It means, changed parameter settings will be saved in the internal Flash-EEPROM and will be kept also after the sensor is switched off.

In case settings should be changed quite often or continuously the flash mode can be switched off by using the following command:

Decimal: 112

HEX: 0x70

Data, Answer: byte 1

Result: 1 – Data will be written into the flash memory

2 – Data will not be written into the flash memory

If the flash mode is deactivated, all settings will only be kept as long as the unit is powered. If the unit is switched off and powered on again all previous settings are lost.

The command 0x71 will poll the current status.

You will find a detailed protocol and command description on the software CD CompactConnect in the directory: \Commands.

13. Basics of Infrared Thermometry

Depending on the temperature each object emits a certain amount of infrared radiation. A change in the temperature of the object is accompanied by a change in the intensity of the radiation. For the measurement of “thermal radiation” infrared thermometry uses a wave-length ranging between 1μ and $20 \mu\text{m}$. The intensity of the emitted radiation depends on the material. This material contingent constant is described with the help of the emissivity (ϵ - Epsilon) which is a known value for most materials, [see 14](#).

Infrared thermometers are optoelectronic sensors. They calculate the surface temperature on the basis of the emitted infrared radiation from an object. The most important feature of infrared thermometers is that they enable the user to measure objects contactless. Consequently, these products help to measure the temperature of inaccessible or moving objects without difficulties. Infrared thermometers basically consist of the following components:

- Lens
- Spectral filter
- Detector
- Controller (Amplifier/linearization/signal processing)

The specifications of the lens decisively determine the optical path of the infrared thermometer, which is characterized by the ratio Distance to Spot size.

The spectral filter selects the wavelength range, which is relevant for the temperature measurement. The emitted infrared radiation is transformed into electrical signals by the detector and the controller.

14. Emissivity

14.1 Definition

The intensity of infrared radiation, which is emitted by each body, depends on the temperature as well as on the radiation features of the surface material of the measuring object. The emissivity (ϵ – Epsilon) is used as a material constant factor to describe the ability of the body to emit infrared energy. It can range between 0 and 100 %. A “blackbody” is the ideal radiation source with an emissivity of 1.0 whereas a mirror shows an emissivity of 0.1.

If the emissivity chosen is too high, the infrared thermometer may display a temperature value which is much lower than the real temperature – assuming the measuring object is warmer than its surroundings. A low emissivity (reflective surfaces) carries the risk of inaccurate measuring results by interfering infrared radiation emitted by background objects (flames, heating systems, chamottes). To minimize measuring errors in such cases, the handling should be performed very carefully and the unit should be protected against reflecting radiation sources.

14.2 Determination of Unknown Emissivity

- First of all, determine the current temperature of the measuring object with a thermocouple or contact sensor. The second step is to measure the temperature with the infrared thermometer and modify the emissivity until the displayed measuring value corresponds to the current temperature.
- If you monitor temperatures of up to 380 °C you may place a special plastic sticker (Part number: TM-ED-CT emissivity dots) onto the measuring object, which covers it completely.

➡ Now set the emissivity to 0.95 and take the temperature of the sticker.

➡ Afterwards, determine the temperature of the adjacent area on the measuring object and adjust the emissivity according to the value of the temperature of the sticker.

- Cover a part of the surface of the measuring object with a black, flat paint with an emissivity of 0.98.

➡ Adjust the emissivity of your infrared thermometer to 0.98 and take the temperature of the colored surface.

➡ Afterwards, determine the temperature of a directly adjacent area and modify the emissivity until the measured value corresponds to the temperature of the colored surface.

•
i

On all three methods the object temperature must be different from the ambient temperature.

14.3 Characteristic Emissivity

In the case that none of the methods mentioned above help to determine the emissivity you may use the emissivity tables, [see A 3](#), [see A 4](#). These are only average values. The actual emissivity of a material depends on the following factors:

- Temperature
- Measuring angle
- Geometry of the surface (smooth, convex, concave)
- Thickness of the material
- Constitution of the surface (polished, oxidized, rough, sandblast)
- Spectral range of the measurement
- Transmissivity (e.g. with thin films)

15. Liability for Material Defects

All components of the device have been checked and tested for functionality at the factory. However, if defects occur despite our careful quality control, MICRO-EPSILON or your dealer must be notified immediately.

The liability for material defects is 12 months from delivery.

Within this period, defective parts, except for wearing parts, will be repaired or replaced free of charge, if the device is returned to MICRO-EPSILON with shipping costs prepaid. Any damage that is caused by improper handling, the use of force or by repairs or modifications by third parties is not covered by the liability for material defects. Repairs are carried out exclusively by MICRO-EPSILON.

Further claims can not be made. Claims arising from the purchase contract remain unaffected. In particular, MICRO-EPSILON shall not be liable for any consequential, special, indirect or incidental damage. In the interest of further development, MICRO-EPSILON reserves the right to make design changes without notification. For translations into other languages, the German version shall prevail.

16. Service, Repair

If the sensor, controller or the sensor cable is defective, please send us the affected parts for repair or exchange.

In the case of faults the cause of which is not clearly identifiable, the entire measuring system must be sent back to:

For customers in USA applies:

Send the affected parts or the entire measuring system back to:

For customers in Canada or South America applies:

Please contact your local distributor.

17. Decommissioning, Disposal

➡ Remove the sensor and controller cables.

Incorrect disposal may cause harm to the environment.

➡ Dispose of the device, its components and accessories, as well as the packaging materials in compliance with the applicable country-specific waste treatment and disposal regulations of the region of use.

MICRO-EPSILON MESSTECHNIK
GmbH & Co. KG
Koenigbacher Str. 15
94496 Ortenburg / Germany
Tel. +49 (0) 8542/ 168-0
Fax +49 (0) 8542 / 168-90
info@micro-epsilon.com
www.micro-epsilon.com

MICRO-EPSILON USA
8120 Brownleigh Dr.
Raleigh, NC 27617 /USA
Tel. +1 919 / 787-9707
Fax +1 919 / 787-9706
me-usa@micro-epsilon.com
www.micro-epsilon.com

Appendix

A 1 Optional Accessories

All accessories can be ordered using the according part numbers in brackets [].

A 1.1 Air Purge Collar

The lens must be kept clean at all times from dust, smoke, fumes and other contaminants in order to avoid reading errors. These effects can be reduced by using an air purge collar.

i Make sure to use oil-free, technically clean air, only.

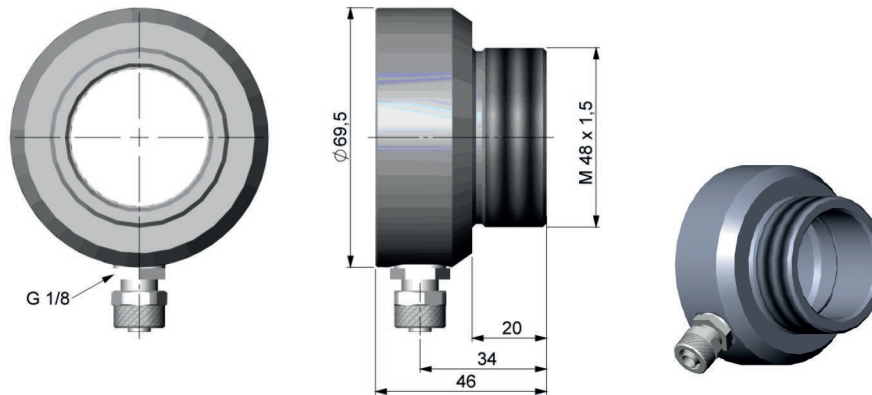

Fig. 33 Dimensions Air Purge Collar [TM-AP-CTL], hose connection: 6x8 mm, thread (fitting): G 1/8 inch

Dimensions in mm, not to scale

The needed amount of air (approximately 2 ... 10 l/ min.) depends on the application and the installation conditions on-site.

A 1.2 Mounting Bracket

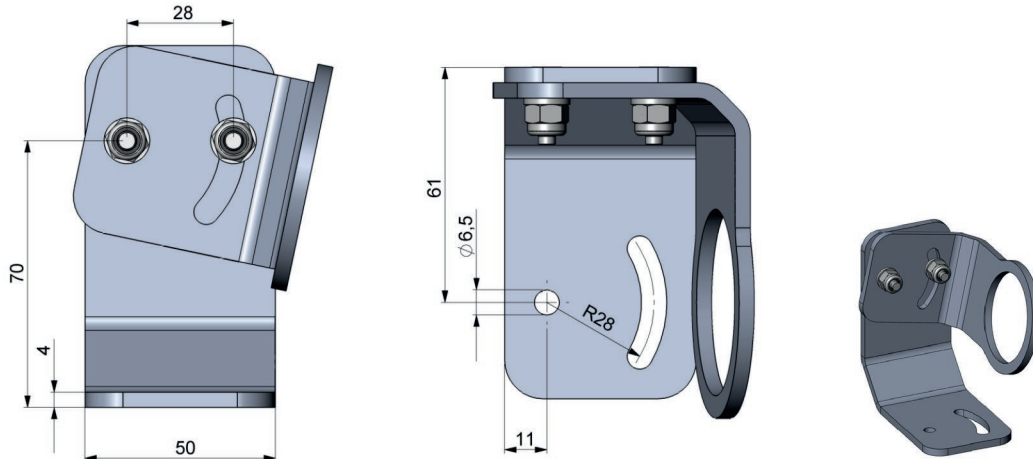

Fig. 34 Dimensions mounting bracket, adjustable in two axes [TM-AB-CTL]

Dimensions in mm, not to scale

The adjustable mounting bracket allows an adjustment of the sensor in two axes.

A 1.3 Water Cooled Housing

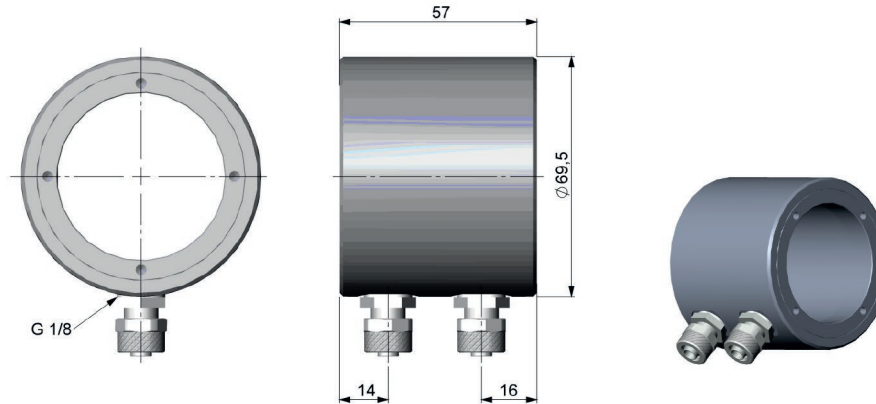

Fig. 35 Dimensions water cooled housing [TM-W-CTL], hose connection: 6x8 mm, thread (fitting): G 1/8 inch

Dimensions in mm, not to scale

•
i To avoid condensation on the optics an air purge collar is recommended.

Water flow rate: approx. 2 l/ min

•
i Cooling water temperature should not exceed 30 °C.

The sensor can be used at ambient temperatures up to 85 °C without cooling. For applications, where the ambient temperature can reach higher values, the usage of the optional water cooled housing is recommended (ambient temperature up to 175 °C). The sensor should be equipped with the optional high temperature cable (ambient temperature up to 180 °C).

A 1.4 High Temperature Cable

For applications, where the ambient temperature can reach higher values, the usage of an optional high temperature cable is also recommended (ambient temperature up to 180 °C).

A 1.5 Rail Mount Adapter for Controller

With the rail mount adapter the CTlaser controller can be mounted easily on a DIN rail (TS35) according EN 50022.

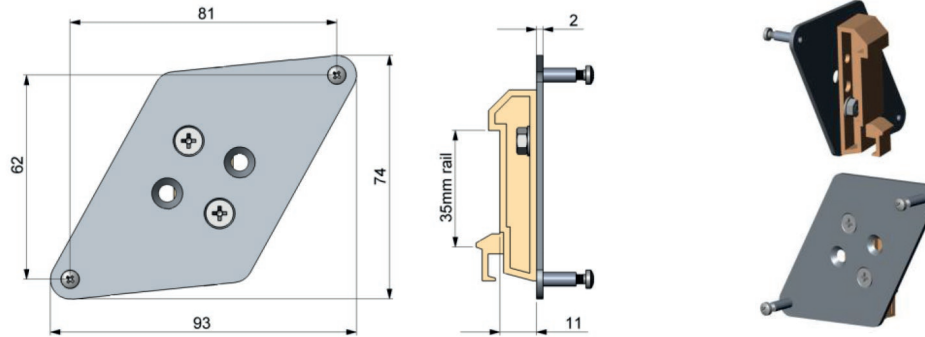

Fig. 36 Rail mount adapter [TM-RAIL-CTL]

Dimensions in mm, not to scale

A 2 Factory Settings

The devices have following presettings at time of delivery:

Signal output object temperature	0 - 5 V
Emissivity	0.970 (1,000 at CTLM)
Transmissivity	1.000
Average time (AVG)	0.2 s (LTL); 0.1 (CTLF, CTLC-4, CTLC-2, CTLC-6, CTLG); inactive (CTLM-5, CTLM-1, CTLM-2, CTLM-3L, CTLM-3H, CTLM-3H1 to -3H3)
Smart Averaging	inactive (CTLF: M1, M2, M3 active)
Peak hold (MAX)	inactive
Valley hold (MIN)	inactive

Smart Averaging means a dynamic average adaptation at high signal edges (Activation via software only).

Model	CTL/CTLF	M-1L	M-1H	M-1H1	M-2L	M-2H	M-2H1	M-3L
Lower limit temperature range [°C]	0	485	650	800	250	385	490	50
Upper limit temperature range [°C]	500	1050	1800	2200	800	1600	2000	375
Lower alarm limit [°C] (normally closed)	30	600	800	1200	350	500	800	100
Upper alarm limit [°C] (normally open)	100	900	1400	1600	600	1200	1400	300
Lower limit signal output	0 V							
Upper limit signal output	5 V							
Temperature unit	°C							
Ambient temperature compensation	Sensor temperature probe (output at OUT-AMB: 0-5 V ▶ -20-180 °C; not available on 1M and 2M models)							
Baud rate [kBaud]	CTL: 9.6 / M-xL, M-xH: 115/ CTLG: 9.6							
Laser	inactive							

Model	M-3H	M-3H1	M-3H2	M-3H3	M-5
Lower limit temperature range [°C]	100	150	200	350	1000
Upper limit temperature range [°C]	600	900	1200	1800	2000
Lower alarm limit [°C] (normally closed)	200	350	550	750	1200
Upper alarm limit [°C] (normally open)	500	600	1000	1200	1600
Lower limit signal output	0 V				
Upper limit signal output	5 V				
Temperature unit	°C				
Ambient temperature compensation	Sensor temperature probe				
Baud rate [kBaud]	115				
Laser	inactive				

Model	CTLC-2	CTLC-4	CTLC-6	GL	GH
Lower limit temperature range [°C]	200	200	200	100	250
Upper limit temperature range [°C]	1450	1450	1450	1200	1650
Lower alarm limit [°C] (normally closed)	400	400	400	200	350
Upper alarm limit [°C] (normally open)	1200	1200	1200	500	900
Lower limit signal output	0 V				
Upper limit signal output	5 V				
Temperature unit	°C				
Ambient temperature compensation	Sensor temperature probe (output at OUT-AMB: 0 - 5 V ▶ -20 - 180 °C)				
Baud rate [kBaud]	115				
Laser	inactive				

A 3 Emissivity Table Metals

i Please note that these are only approximate values, which were taken from various sources.

Material		Typical Emissivity			
		1.0 μm	1.6 μm	5.1 μm	8 - 14 μm
Spectral response		1.0 μm	1.6 μm	5.1 μm	8 - 14 μm
Aluminum	Non oxidized	0.1 - 0.2	0.02 - 0.2	0.02 - 0.2	0.02 - 0.1
	Polished	0.1 - 0.2	0.02 - 0.1	0.02 - 0.1	0.02 - 0.1
	Roughened	0.2 - 0.8	0.2 - 0.6	0.1 - 0.4	0.1 - 0.3
	Oxidized	0.4	0.4	0.2 - 0.4	0.2 - 0.4
Brass	Polished	0.35	0.01 - 0.05	0.01 - 0.05	0.01 - 0.05
	Roughened	0.65	0.4	0.3	0.3
	Oxidized	0.6	0.6	0.5	0.5
Copper	Polished	0.05	0.03	0.03	0.03
	Roughened	0.05 - 0.2	0.05 - 0.2	0.05 - 0.15	0.05 - 0.1
	Oxidized	0.2 - 0.8	0.2 - 0.9	0.5 - 0.8	0.4 - 0.8
Chrome		0.4	0.4	0.03 - 0.3	0.02 - 0.2
Gold		0.3	0.01 - 0.1	0.01 - 0.1	0.01 - 0.1
Haynes	Alloy	0.5 - 0.9	0.6 - 0.9	0.3 - 0.8	0.3 - 0.8
Inconel	Electro polished	0.2 - 0.5	0.25	0.15	0.15
	Sandblast	0.3 - 0.4	0.3 - 0.6	0.3 - 0.6	0.3 - 0.6
	Oxidized	0.4 - 0.9	0.6 - 0.9	0.6 - 0.9	0.7 - 0.95

Material		Typical Emissivity			
		1.0 μm	1.6 μm	5.1 μm	8 - 14 μm
Spectral response		1.0 μm	1.6 μm	5.1 μm	8 - 14 μm
Iron	Non oxidized	0.35	0.1 - 0.3	0.05 - 0.25	0.05 - 0.2
	Rusted		0.6 - 0.9	0.5 - 0.8	0.5 - 0.7
	Oxidized	0.7 - 0.9	0.5 - 0.9	0.6 - 0.9	0.5 - 0.9
	Forget, blunt	0.9	0.9	0.9	0.9
	Molten	0.35	0.4 - 0.6		
Iron, casted	Non oxidized	0.35	0.3	0.25	0.2
	Oxidized	0.9	0.7 - 0.9	0.65 - 0.95	0.6 - 0.95
Lead	Polished	0.35	0.05 - 0.2	0.05 - 0.2	0.05 - 0.1
	Roughened	0.65	0.6	0.4	0.4
	Oxidized		0.3 - 0.7	0.2 - 0.7	0.2 - 0.6
Magnesium		0.3 - 0.8	0.05 - 0.3	0.03 - 0.15	0.02 - 0.1
Mercury			0.05 - 0.15	0.05 - 0.15	0.05 - 0.15
Molybdenum	Non oxidized	0.25 - 0.35	0.1 - 0.3	0.1 - 0.15	0.1
	Oxidized	0.5 - 0.9	0.4 - 0.9	0.3 - 0.7	0.2 - 0.6
Monel (Ni-CU)		0.3	0.2 - 0.6	0.1 - 0.5	0.1 - 0.14
Nickel	Electrolytic	0.2 - 0.4	0.1 - 0.3	0.1 - 0.15	0.05 - 0.15
	Oxidized	0.8 - 0.9	0.4 - 0.7	0.3 - 0.6	0.2 - 0.5
Platinum	Black		0.95	0.9	0.9
Silver		0.04	0.02	0.02	0.02

Material		Typical Emissivity			
Spectral response		1.0 μm	1.6 μm	5.1 μm	8 - 14 μm
Steel	Polished plate	0.35	0.25	0.1	0.1
	Rustless	0.35	0.2 - 0.9	0.15 - 0.8	0.1 - 0.8
	Heavy plate			0.5 - 0.7	0.4 - 0.6
	Cold-rolled	0.8 - 0.9	0.8 - 0.9	0.8 - 0.9	0.7 - 0.9
	Oxidized	0.8 - 0.9	0.9 - 0.9	0.7 - 0.9	0.7 - 0.9
Tin	Non oxidized	0.25	0.1 - 0.3	0.05	0.05
Titanium	Polished	0.5 - 0.75	0.3 - 0.5	0.1 - 0.3	0.05 - 0.2
	Oxidized		0.6 - 0.8	0.5 - 0.7	0.5 - 0.6
Wolfram	Polished	0.35 - 0.4	0.1 - 0.3	0.05 - 0.25	0.03 - 0.1
Zinc	Polished	0.5	0.05	0.03	0.02
	Oxidized	0.6	0.15	0.1	0.1

A 4 Emissivity Table Non Metals

i Please note that these are only approximate values which were taken from various sources.

Material	Typical Emissivity			
	1.0 μm	2.3 μm	5.1 μm	8 - 14 μm
Spectral response				
Asbest	0.9	0.8	0.9	0.95
Aphalt			0.95	0.95
Basalt			0.7	0.7
Carbon	Non oxidized	0.8 - 0.9	0.8 - 0.9	0.8 - 0.9
	Graphite	0.8 - 0.9	0.7 - 0.9	0.7 - 0.9
Carborundum	0.4	0.8 - 0.95	0.8 - 0.95	0.95
Cement	0.65	0.9	0.9	0.95
Ceramic	0.65	0.9	0.9	0.95
Glass	Plate	0.2	0.98	0.85
	Melt	0.4 - 0.9	0.9	
Grit			0.95	0.95
Gypsum			0.4 - 0.97	0.8 - 0.95
Ice				0.98
Limestone			0.4 - 0.98	0.98
Paint	Non alkaline			0.9 - 0.95
Paper	Any color		0.95	0.95
Plastic > 50 μm	Non transparent		0.95	0.95
Rubber			0.9	0.95

Material	Typical Emissivity			
	1.0 μm	2.3 μm	5.1 μm	8 - 14 μm
Spectral response				
Sand			0.9	0.95
Snow				0.9
Soil				0.9 - 0.98
Textiles			0.95	0.95
Water				0.93
Wood	Natural		0.9 - 0.95	0.9 - 0.95

A 5 Smart Averaging

The average function is generally used to smoothen the output signal. With the adjustable parameter time this function can be optimal adjusted to the respective application. One disadvantage of the average function is that fast temperature peaks which are caused by dynamic events are subjected to the same averaging time. Therefore those peaks can only be seen with a delay on the signal output. The function Smart Averaging eliminates this disadvantage by passing those fast events without averaging directly through to the signal output.

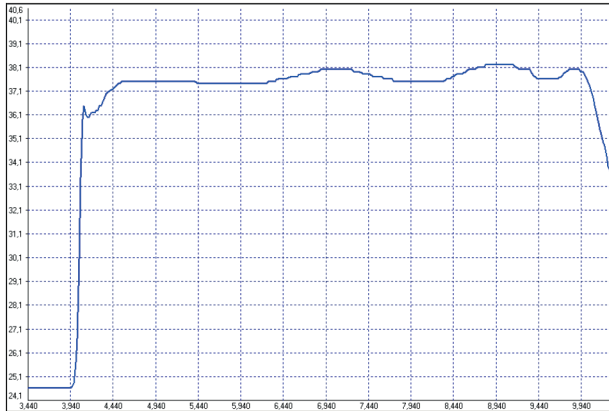

Fig. 37 Signal graph with Smart Averaging function

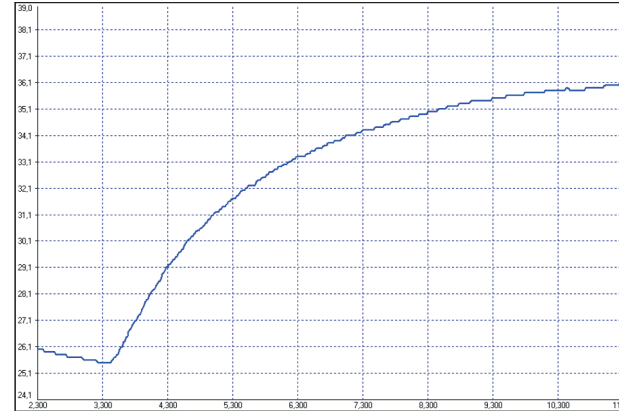

Fig. 38 Signal graph without Smart Averaging function



MICRO-EPSILON MESSTECHNIK GmbH & Co. KG
Koenigbacher Str. 15 · 94496 Ortenburg / Germany
Tel. +49 (0) 8542 / 168-0 · Fax +49 (0) 8542 / 168-90
info@micro-epsilon.com · www.micro-epsilon.com

X9751197-B042040HDR

© MICRO-EPSILON MESSTECHNIK

